

# GREAT CARE GCI











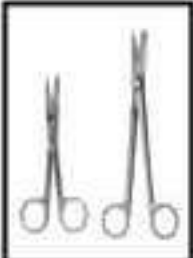

---

## INSTRUMENTS

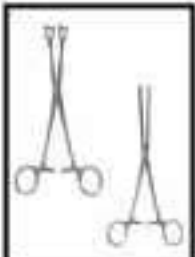
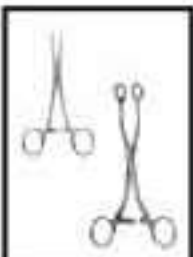
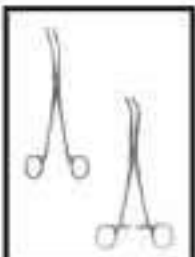
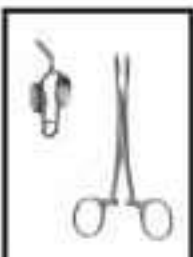

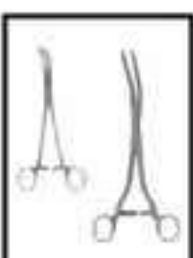







Surgical Instruments  
Catalogue

## Table Of Contents

	Page Seite			Page Seite	
Diagnostic, Anaesthesia and other instruments					
Diagnostyka, Anestezjologia, Narzędzia różne	1 - 10		Probes, Pocket Instruments sets	66 - 68	
Scalpels, knives and Scalpel Handles					
Skalpele, nożyki i uchwyt do skalpeli	11 - 14		Wound Retractors	69 - 80	
Scissors					
Nożyczki	15 - 31		Self-Retaining Retractors, Abdominal Retractors	81 - 85	
Dissecting-and Tissue Forceps					
Pincety preparacyjne i chirurgiczne	32 - 42		Abdominal Surgery Intestinal-and Rectal Instruments	86 - 93	
Sponge, Dressing and Tissue Grasping Forceps Towel Clamps					
Pincety do tamponowania, anatomiczne, Chirurgiczne chwytające, spinaki	43 - 48		Gall Bladder-, Liver-and Spleen Instruments	94 - 96	
Vessel Clips, Bulldog Clamps Haemostatic Forceps					
Zaciski do naczyń, kłamry typ Bulldog, Kleszczyki naczyniowe	49 - 57		Genito-Urinary Instruments and Trocars	97 - 100	
Ligature, Hysterectomy and Compression Forceps Vaginal Clamps					
Narzędzia do ligatury Narzędzia do macicy, kleszcze ściskające, kleszcze dopochwowe	58 - 60		Vaginal Specula and Uterine Dilators	101 - 106	
Needle Holders, Suture Instruments					
Igłotrzymacze, narzędzia do szycia	61 - 65		Uterine Probes, Uterine Dressing-, Polypus-and Ovum Forceps	107 - 109	
			Zgłębniki maciczne, kleszczyki do polipów i jajeczek		

## Table Of Contents

	Page Seite			Page Seite	
Biopsy Instruments and Curettes	110 - 116		Suction Instruments	158 - 166	
Narzędzia biopsyjne, łyżeczki			Narzędzia ssące		
Obstetrics and Tracheotomy	117 - 119				
Położnictwo i tracheotomia					
Cardiovascular-and Thoracic Surgery	120 - 128				
Chirurgia naczyniowa i torakochirurgia					
Bone Punches, Rongeurs	129 - 134				
Przebijaki kostne i odgryzacze					
Elevators, Bone Levers, Raspatories, Bone Files, Bone Curettes	135 - 139				
Podważki, dźwignie, skrobaczki, pilniki, łyżeczki kostne					
Mallets, Chisels and Gouges	140 - 141				
Młotki, dłuta, dłuta wklęsłe					
Bone Holding Forceps, Bone Rongeurs, Bone Cutting Forceps	142 - 146				
Kleszcze do kości, kleszcze tnące					
Plaster Instruments	147 - 157				
Narzędzia do gipsu					

## Percussion Hammers and Aesthesiometers



# Stethoscopes



**01-110**  
PINARD (Aluminum)  
Size: 155 mm

1/2



**01-111**  
wooden  
Size: 145 mm

1/2



**01-112**  
BOWLES  
Stethoscope  
with diaphragm

1/4



**01-113**  
ANESTOPHON

1/2



**01-114**  
FORD-BOWLES  
Dual chest piece  
with two outlets

1/4



**01-115**  
BOWLES

1/4

## Head Mirrors and Head Bands



**01-116**  
ZIEGLER  $\varnothing$  90mm  
head mirror only  
with rubber coating



**01-117**  
ZIEGLER  $\varnothing$  90mm  
head mirror only  
with metal coating



**01-118**  
ZIEGLER  
head band of plastic black

**01-119**  
ZIEGLER  
head band of plastic white



**01-120**  
MURPHY  
head band of celluloid, white



**01-121**  
head band of plastic,  
white, soft pattern



**01-122**  
head mirror with black  
plastic head band.

# Tongue Depressors

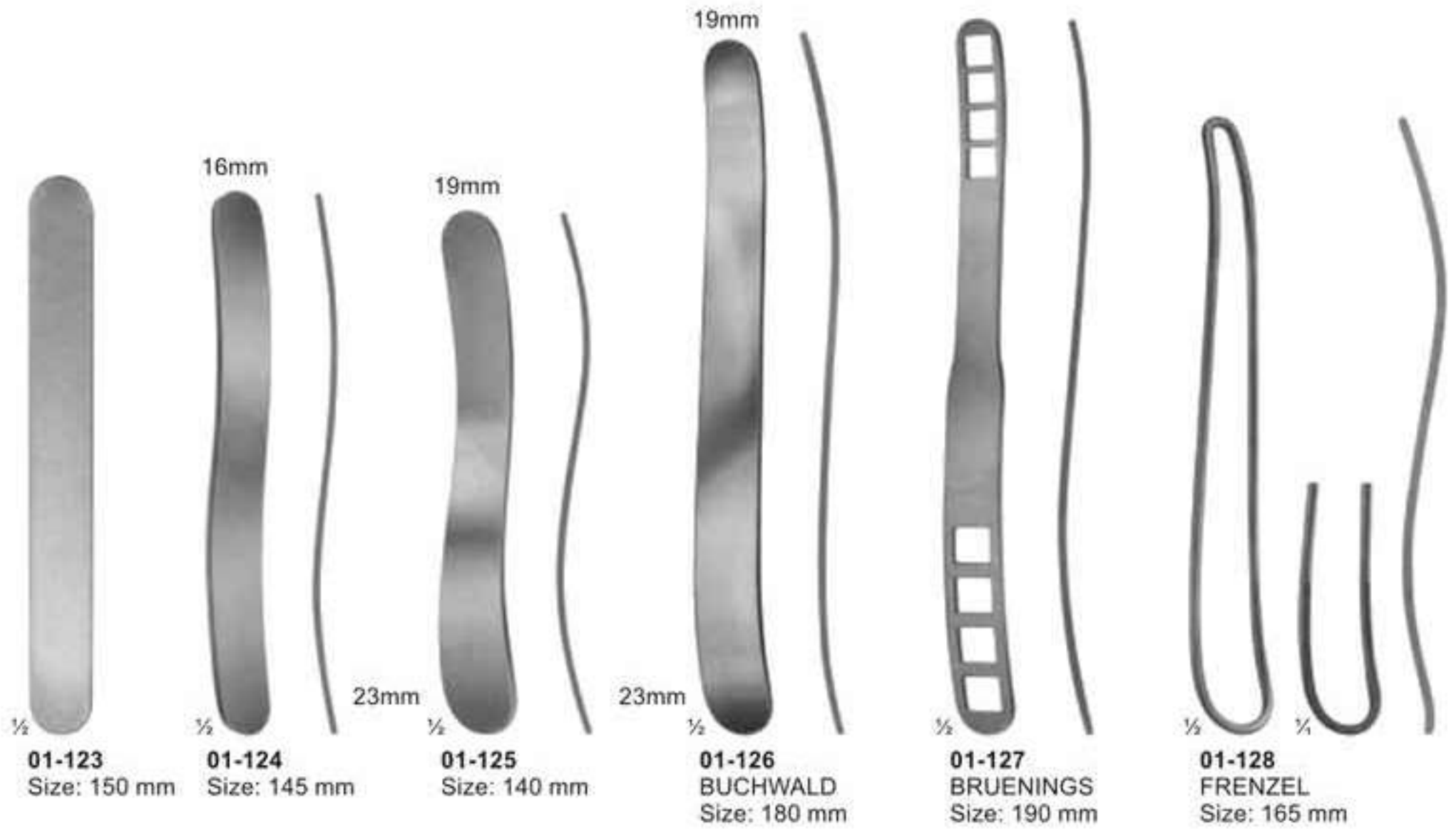

## Instruments for Anaesthesia and Tongue Forceps



1/2  
**01-134**  
SCHIMMELBUSCH  
Ether mask



1/2  
**01-135**  
HEISTER  
Mouth gag  
Size: 130 mm



1/2  
**01-136**  
FERGUSON-ACKLAND  
Mouth gag  
Size: 145 mm



1/2  
**01-137**  
DENHARDT  
Mouth gag with silicon  
inserts, interchangeable  
Size: 125 mm



1/2  
**01-138**  
ROSER KOENIG  
Mouth gag  
Size: 160 mm, 185 mm

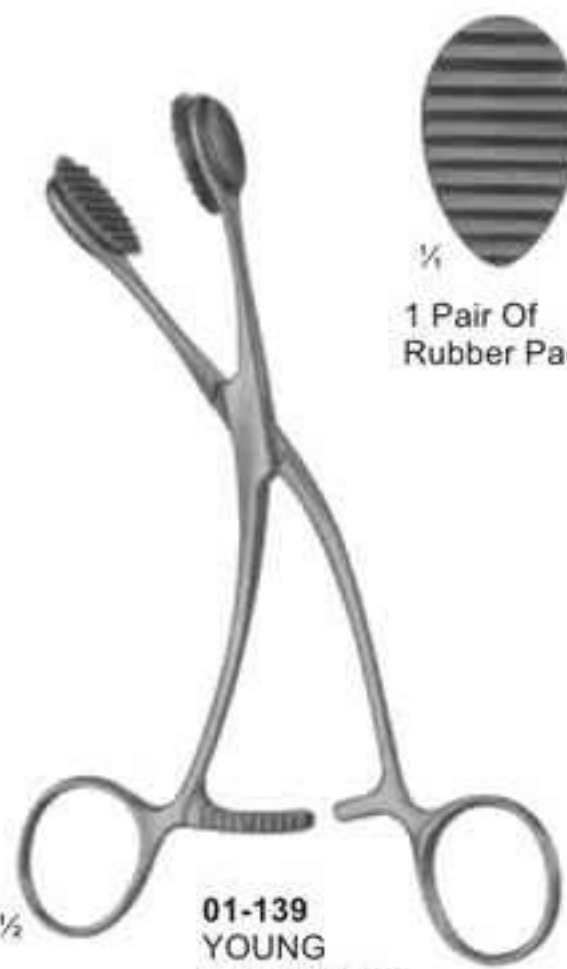

1/2  
**01-139**  
YOUNG  
Size: 165 mm



1/2  
1 Pair Of  
Rubber Pads

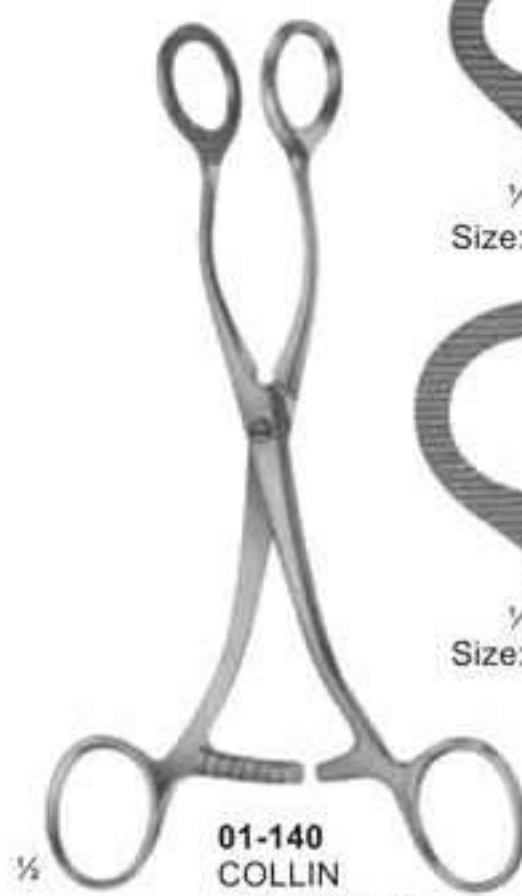

1/2  
**01-140**  
COLLIN  
Size: 160 mm,  
170 mm



1/2  
Size: 160 mm



1/2  
Size: 170 mm



1/2  
**01-141**  
HEYWOOD-SMITH  
modif. Size: 215 mm



## Blood Lancets and Laryngeal Mirrors

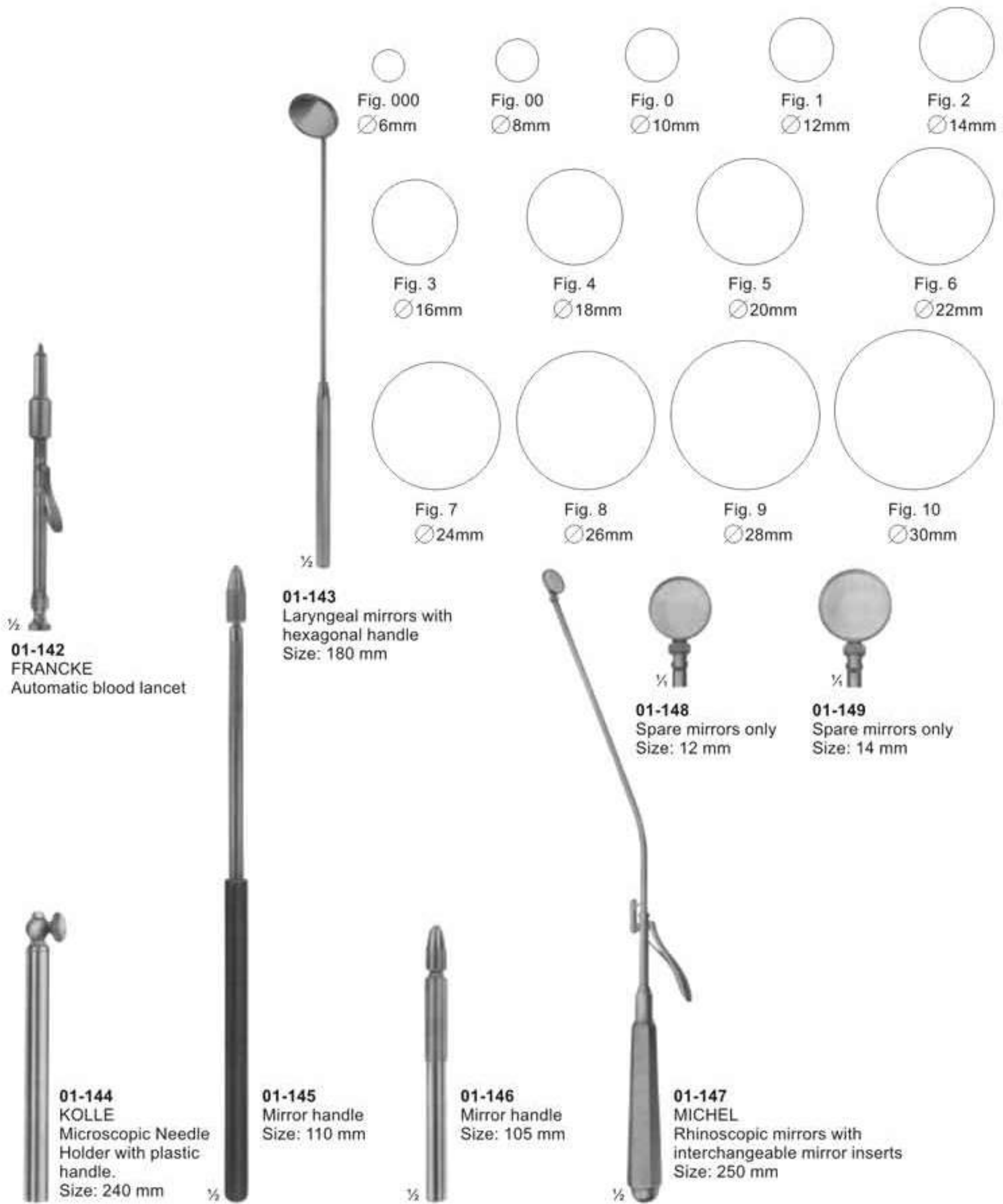

**01-142**  
FRANCKE  
Automatic blood lancet

**01-143**  
Laryngeal mirrors with  
hexagonal handle  
Size: 180 mm

**01-148**  
Spare mirrors only  
Size: 12 mm

**01-149**  
Spare mirrors only  
Size: 14 mm

**01-144**  
KOLLE  
Microscopic Needle  
Holder with plastic  
handle.  
Size: 240 mm

**01-145**  
Mirror handle  
Size: 110 mm

**01-146**  
Mirror handle  
Size: 105 mm

**01-147**  
MICHEL  
Rhinoscopic mirrors with  
interchangeable mirror inserts  
Size: 250 mm

Fig. 000  
Ø6mm

Fig. 00  
Ø8mm

Fig. 0  
Ø10mm

Fig. 1  
Ø12mm

Fig. 2  
Ø14mm

Fig. 3  
Ø16mm

Fig. 4  
Ø18mm

Fig. 5  
Ø20mm

Fig. 6  
Ø22mm

Fig. 7  
Ø24mm

Fig. 8  
Ø26mm

Fig. 9  
Ø28mm

Fig. 10  
Ø30mm

## Diagnostic Sets



**01-153**  
Ophthalmoscope



$\frac{1}{2}$  **01-150 - 152**  
MAGILL  
Catheter Introducing Forceps



$\frac{1}{4}$  **01-152**  
Adults  
Size: 250 mm



**01-154**  
Otoscope & Pouch



$\frac{1}{2}$  **01-153-A**  
Medium battery handle  
only, 25 mm diam.



**01-153-B**  
Spare bulb  
2.7 volt, for  
otoscopes



**01-153-C**  
Spare bulb  
2.6 volt, for  
ophthalmoscopes



**01-155**  
ENT Set



**01-156**  
ENT Set  
Otoscope, consists of  
battery handle without batteries,  
3 ear specula, 1 bulb in velvet lined case



**01-157**  
Otoscope Set with three specula.

# Laryngoscopes



**01-158**  
**MILLER**  
Laryngoscope set, consists of battery handle ( without battery )  
with five miller laryngoscope blades

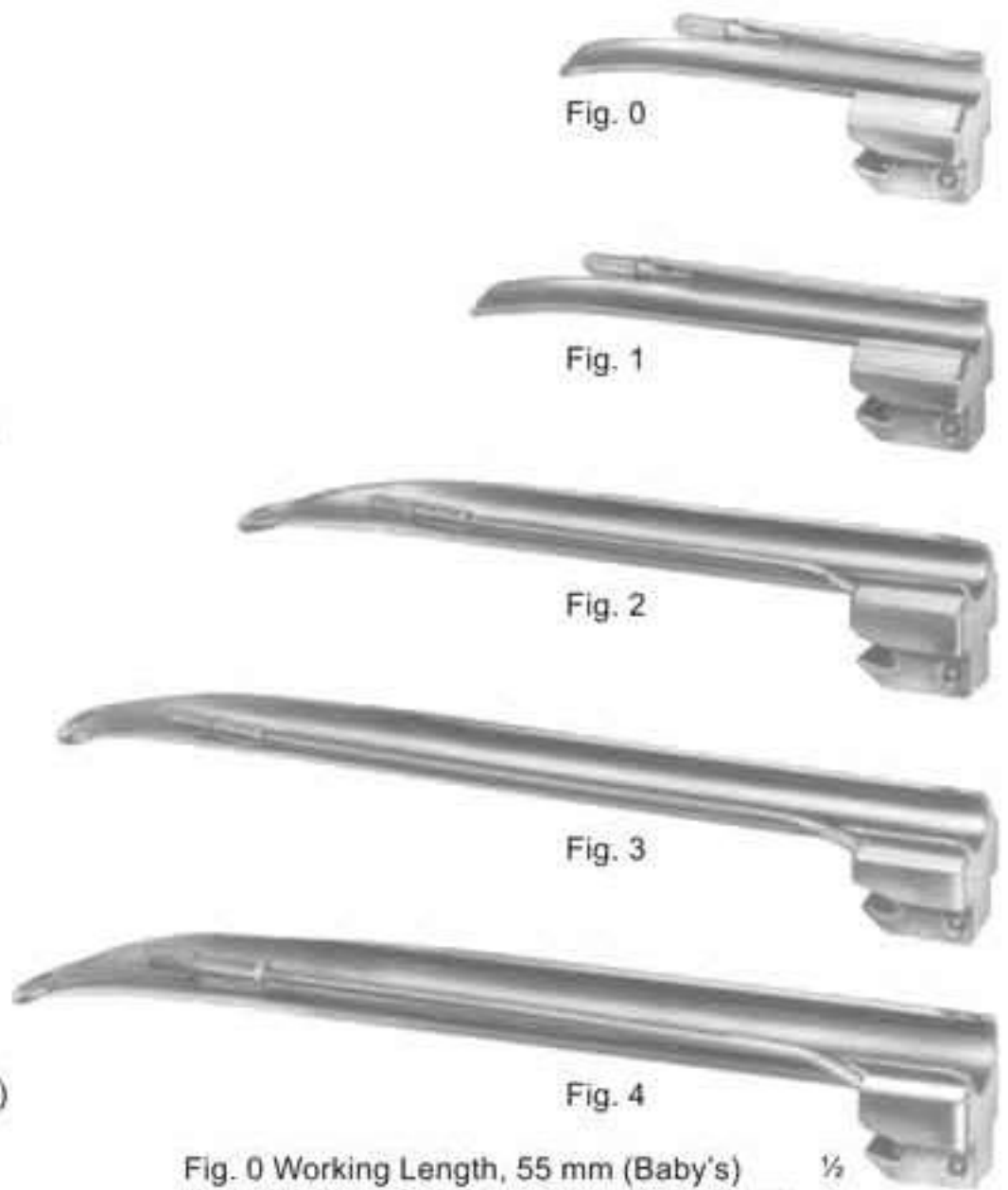

Fig. 0 Working Length, 55 mm (Baby's)  $\frac{1}{2}$   
Fig. 1 Working Length, 80 mm (Children's)  
Fig. 2 Working Length, 130 mm (Adolescent's)  
Fig. 3 Working Length, 170 mm (Women's)  
Fig. 4 Working Length, 180 mm (Men's)



**01-159**  
**GUEDEL-NEGUS**  
Laryngoscope set, consists of battery handle ( without battery )  
with four miller laryngoscope blades

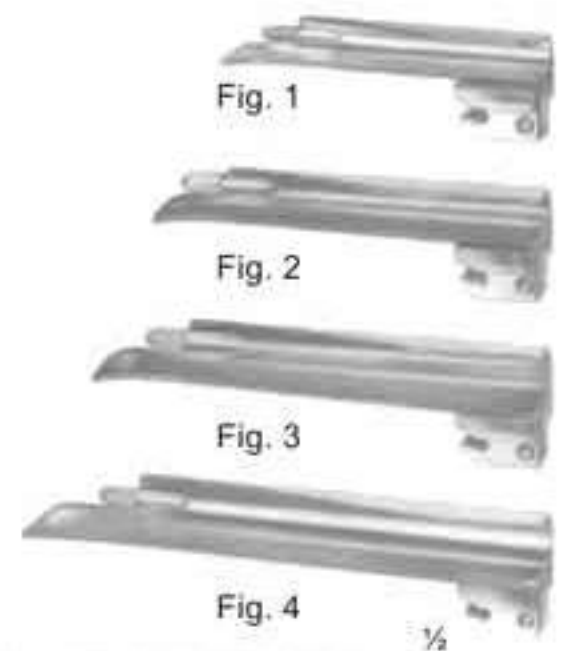

Fig. 1 Working Length, 70 mm (Children's)  
Fig. 2 Working Length, 90 mm (Adolescent's)  
Fig. 3 Working Length, 110 mm (Women's)  
Fig. 4 Working Length, 135 mm (Men's)

# Laryngoscopes



**01-160**  
McINTOSH  
Laryngoscope Set, Consists Of Battery Handle ( Without Battery )  
With Three McIntosh Blades, Fig. 1, Fig. 2, Fig. 3

**01-161**  
McINTOSH  
Laryngoscope Set, Consists Of Battery Handle ( Without Battery )  
With Five McIntosh Blades, Fig. 0, Fig. 1, Fig. 2, Fig. 3, Fig. 4

Fig. 0

Fig. 1

Fig. 2

Fig. 3

Fig. 4

01-161 A Fig. 0 Working Length, 55 mm (Baby's)  
01-161 B Fig. 1 Working Length, 75 mm (Children's)  
01-161 C Fig. 2 Working Length, 90 mm (Adolescent's)  
01-161 D Fig. 3 Working Length, 110 mm (Women's)  
01-161 E Fig. 4 Working Length, 135 mm (Men's)



**01-162**  
FOREGGER  
Laryngoscope Set, Consists Of Battery Handle ( Without Battery )  
With Three Foregger Blades,  
Fig. 1, Fig. 2, Fig. 3.

**01-163**  
FOREGGER  
Laryngoscope Set, Consists Of Battery Handle ( Without Battery )  
With Four Foregger Blades,  
Fig. 1, Fig. 2, Fig. 3, Fig. 4.

Fig. 1

Fig. 2

Fig. 3

Fig. 4

01-162 A Fig. 1 Working Length, 70 mm (Children's)  
01-162 B Fig. 2 Working Length, 90 mm (Adolescent's)  
01-162 C Fig. 3 Working Length, 110 mm (Women's)  
01-162 D Fig. 4 Working Length, 135 mm (Men's)



**01-164**  
Fiber Optic  
Battery Handle  
30mm diam.



**01-165**  
Fiber Optic  
Battery Handle  
18mm diam.



**01-166**  
Replacement Lamp  
( Krypton ) 2.5 V



**01-167**  
Replacement Lamp  
( Halogen ) 2.5 V

## Examination & Measuring Instruments



**01-168**  
Caliper Of Aluminium  
Graduated in mm & inches  
up to 180mm  
Measuring Range up to 139mm



**01-169**  
VERNIER  
Universal Caliper Of Steel  
Graduated in mm & inches  
up to 180mm  
Measuring Range up to 120mm  
with Vernier in 1/10mm & 1/16"



**01-170**  
CARROLL  
Size: 145 mm  
Finger Goniometer



**01-171**  
TOWNLEY  
Graduated in  
mm & inches  
Size: 115 mm



**01-172**  
COLLIN  
Druck Pressure 72 kg  
Size: 125 mm



**01-173**  
BERTILLON  
Caliper For Measuring The Head  
Size: 320 mm



**01-174**  
CASTROVIEJO  
Caliper  
Size: 75mm



**01-175**  
MOLTGEN  
Goniometer



**01-176**  
Size: 150 mm

**01-177**  
Size: 500 mm



# Dissecting Knives



**02-101 - 110**  
Fig. 1 - 10



**02-101**  
Fig. 1  
30 mm



**02-102**  
Fig. 2  
36 mm



**02-103**  
Fig. 3  
40 mm



**02-104**  
Fig. 4  
45 mm



**02-105**  
Fig. 5  
50 mm



**02-106**  
Fig. 6  
27 mm



**02-107**  
Fig. 7  
35 mm

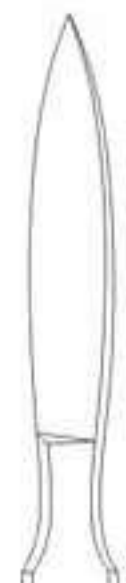

**02-108**  
Fig. 8  
40 mm



**02-109**  
Fig. 9  
47 mm



**02-110**  
Fig. 10  
50 mm

Amputating Knives, Cartilage Knives  
and Autopsy Knives



LISTON  
02-111  
Size: 130 mm  
02-112  
Size: 160 mm  
02-113  
Size: 190 mm  
02-114  
Size: 200 mm

02-115  
CATLIN  
Size: 160 mm  
Blade length  
Amputating  
Knives

02-116  
LANGENBECK  
Size: 120 mm  
Blade length  
Flap Knives

02-117  
Size: 110 mm  
Blade length  
Interosseous  
Knives

02-118  
Size: 55 mm  
Blade length  
with raspatory,  
Wooden handle

02-119  
Size: 70 mm  
Blade length  
Wooden handle

02-120  
Size: 80 mm  
Blade length  
Metal handle

02-121  
Size: 195 mm  
Blade length  
Metal handle

Blade length  
Amputating Knives

# Cone Knives, Myomatome, Trigeminal and Tonsil Knives



**02-122**  
AYRE  
Size: 235 mm  
Cone Knife

**02-123**  
Size: 230 mm  
Cone Knife

**02-124**  
SEGOND  
Size: 270 mm  
Myomatome

**02-125**  
OLIVECRONA  
Size: 205 mm  
Trigeminal  
Knife

**02-126**  
Size: 230 mm  
Trigeminal  
Knife

**02-127**  
FOWLER  
Size: 200 mm  
Tonsil Knife

**02-128**  
ABRAHAM  
Size: 215 mm  
Tonsil Knife

**02-129**  
BRUNINGS  
Size: 215 mm  
Tonsil Knife



## Scalpel Handles

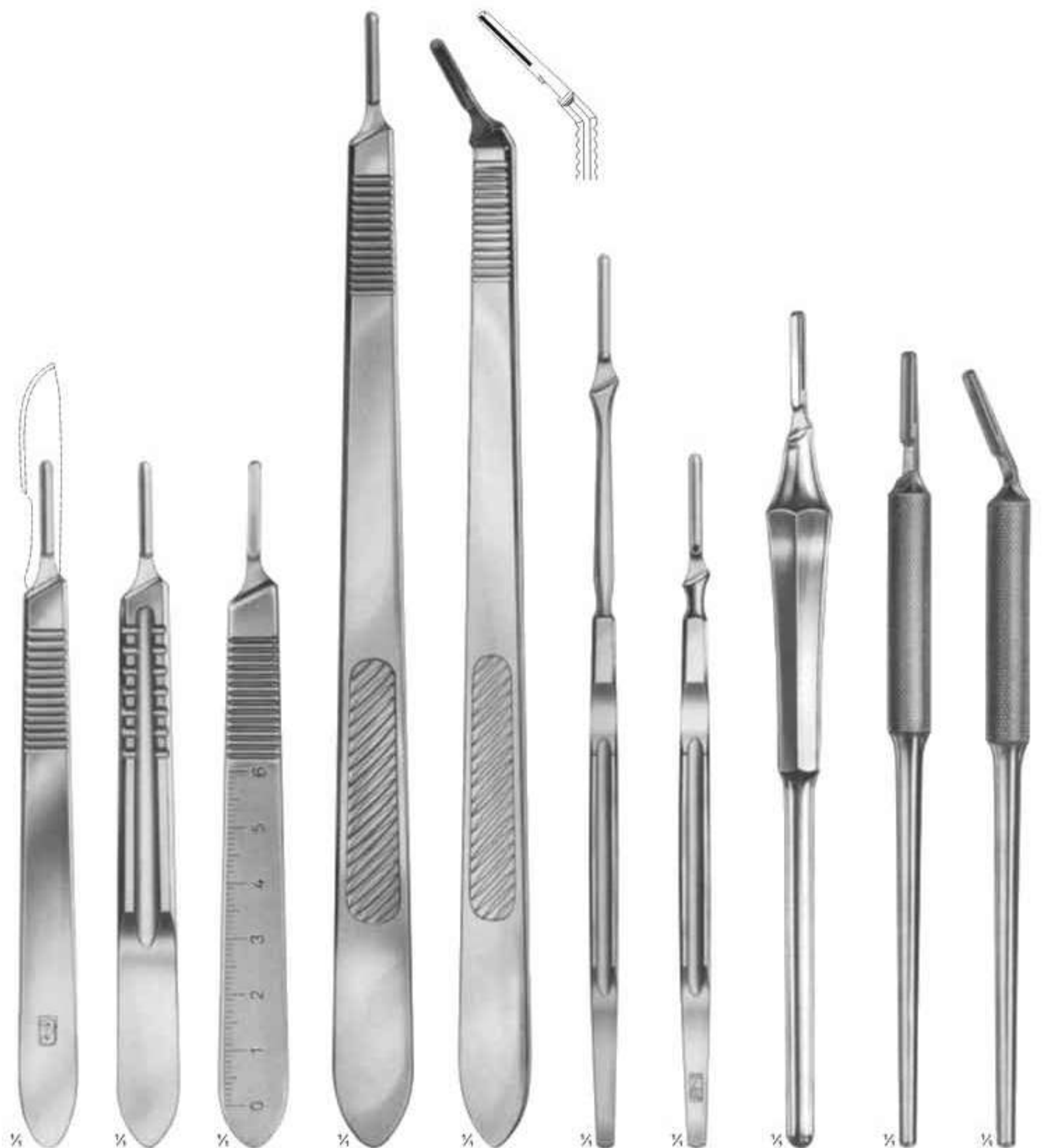

$\frac{1}{8}$   
**02-130**  
STANDARD  
No. 3  
Solid  
12 cm

$\frac{1}{8}$   
**02-131**  
No. 3  
Solid  
12 cm

$\frac{1}{8}$   
**02-132**  
No. 3  
Solid  
12 cm

$\frac{1}{8}$   
**02-133**  
No. 3 L  
Straight  
Solid  
21.5 cm

$\frac{1}{8}$   
**02-134**  
No. 3 L  
Angled  
Solid  
21 cm

$\frac{1}{8}$   
**02-135**  
No. 7  
Solid  
16 cm

$\frac{1}{8}$   
**02-136**  
No. 7 K  
Solid  
12.5 cm

$\frac{1}{8}$   
**02-137**  
Hollow-Round  
15.5 cm

$\frac{1}{8}$   
**02-138**  
No. 3  
Straight  
Solid,  
Round  
14.5 cm

$\frac{1}{8}$   
**02-139**  
No. 3  
Angled  
Solid,  
Round  
14 cm

## Micro Scissors (Spring Type) with Flat Handles

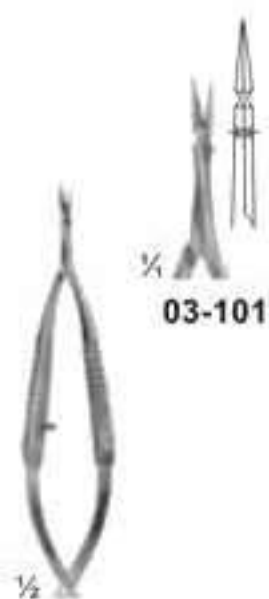

03-101



03-102



03-103

03-101 - 103  
VANNAS  
Size: 85 mm

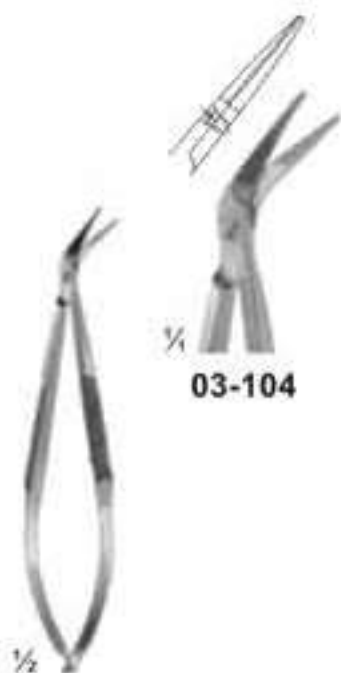

03-104



03-105

03-104 - 105  
CASTROVIEJO  
Size: 95 mm

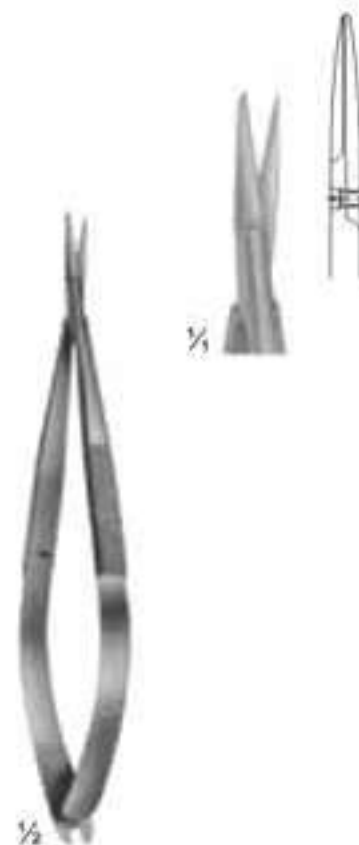

03-106  
NOYES  
Size: 125 mm

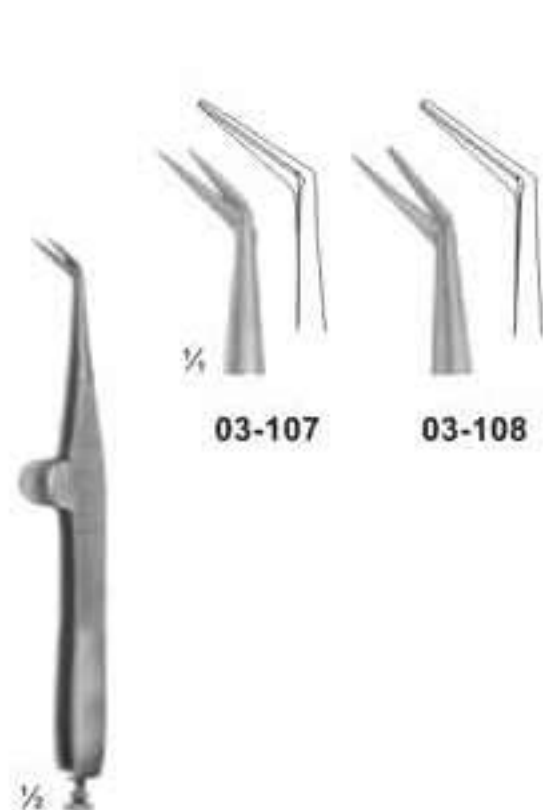

03-107

03-108

03-107 - 108  
WECKER  
Eye scissor  
Size: 110 mm



1/4

03-109  
CASTROVIEJO  
Eye scissor  
Size: 115 mm

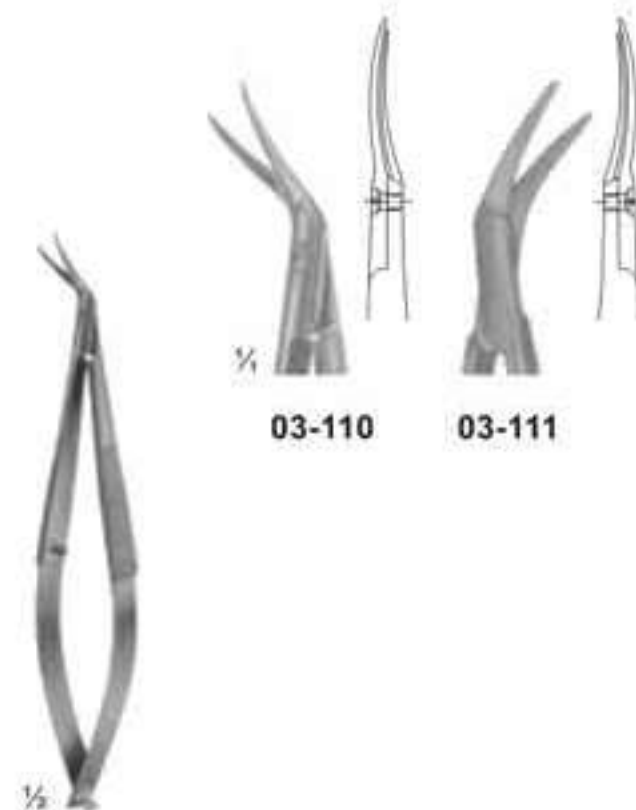

1/4

03-110

03-111

03-110 - 111  
CASTROVIEJO  
Eye scissor  
Size: 110 mm

## Micro Scissors (Spring Type) with Flat Handles

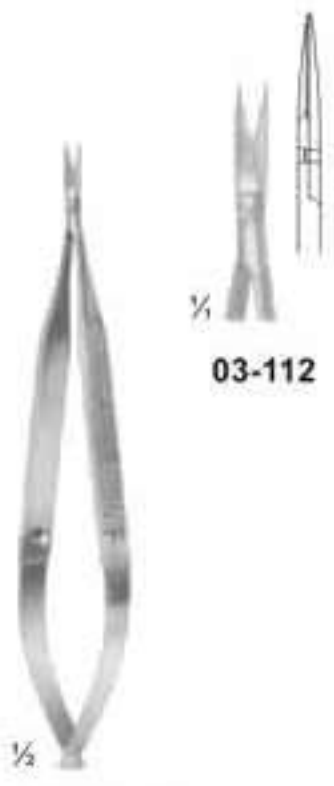

**03-112**



**03-112 - 113**  
Size: 120 mm



**03-114**  
BIEMER  
Vein scissor  
Size: 130 mm



**03-115**  
Size: 160 mm



**03-116 - 117**  
VANNAS  
Size: 160 mm



**03-116**



**03-117**

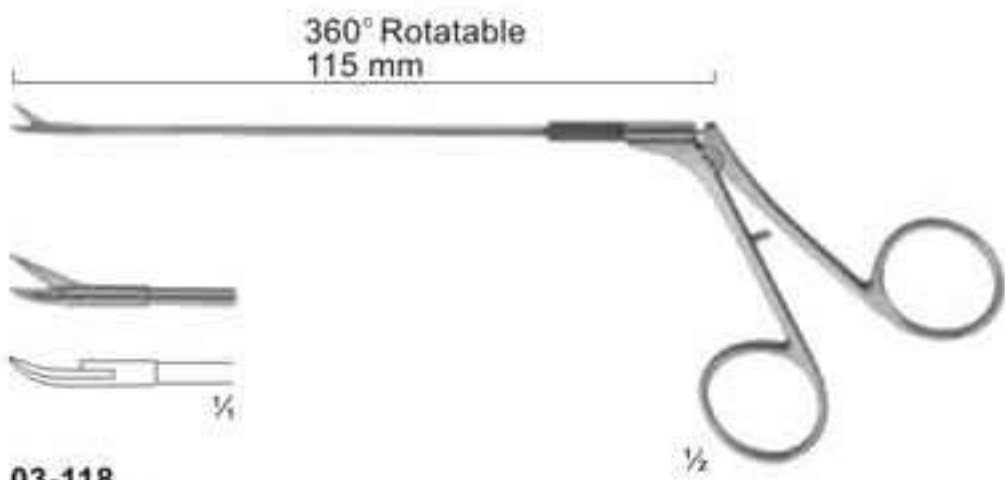

**03-118**  
CASPAR  
Micro scissor curved  
Size: 115 mm



**03-119**



**03-120**



**03-121**



**03-119 - 121**  
Micro dissecting scissor  
Size: 145 mm

## Micro Scissors (Spring Type) bayonet-Shaped



1/2  
**03-122**  
YASARGIL  
Size: 245 mm



1/2  
**03-123**  
45°



1/2  
**03-124**  
45°



125°

1/2  
**03-123 - 124**  
laterally angled  
Size: 200 mm

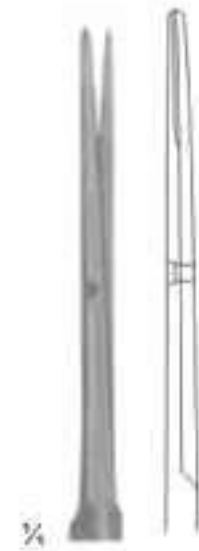

1/2  
**03-126**



1/2  
**03-127**



1/2  
**03-125**  
laterally angled  
Size: 190 mm



1/2  
**03-126 - 127**  
YASARGIL  
Size: 225 mm

## Delicate Scissors



03-128



03-129



03-130



03-131

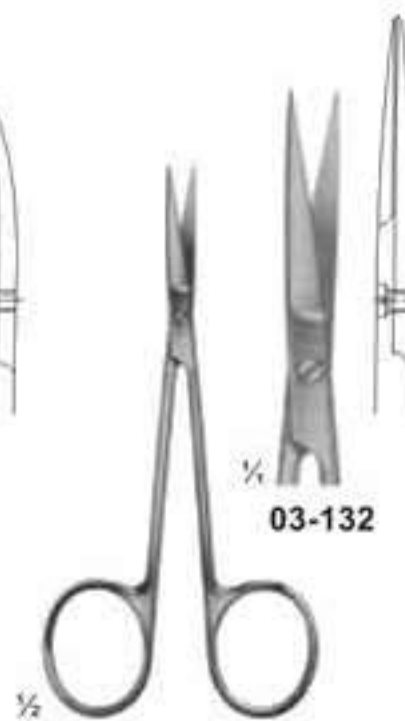

03-132



03-133

03-128 - 129  
Size: 90 mm

03-130 - 131  
Size: 95 mm

03-132 - 133  
Size: 105 mm

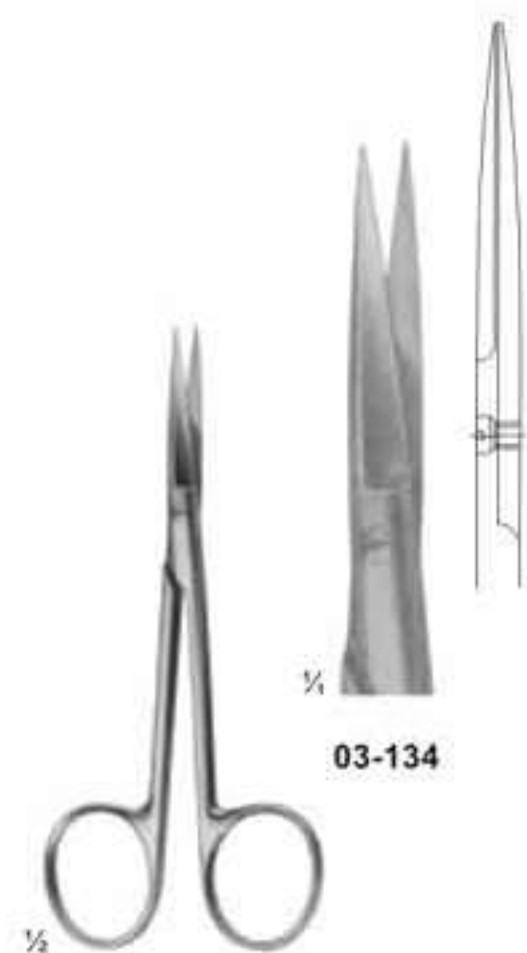

03-134



03-135

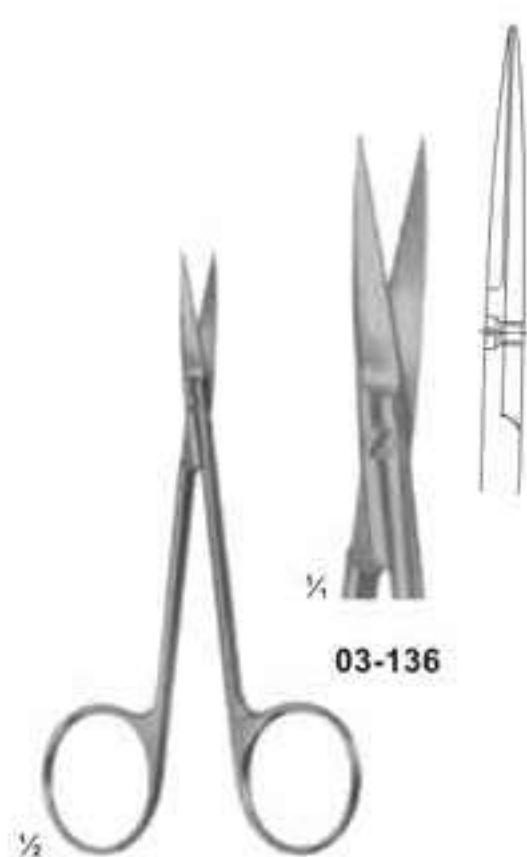

03-136



03-137

03-134 - 135  
Size: 120 mm

03-136 - 137  
Size: 115 mm

## Delicate Scissors



**03-138 - 140**  
Size: 120 mm

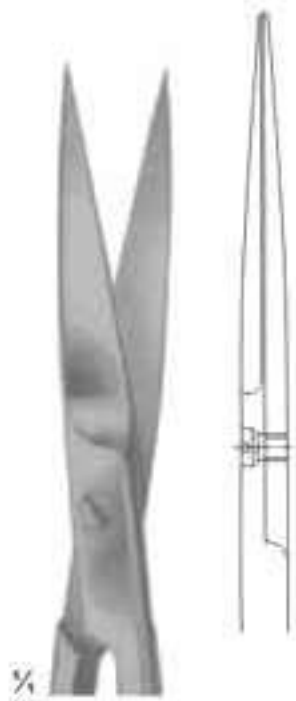

1/2

**03-138**



**03-139**



**03-140**



**03-141 - 144**  
Size: 130 mm

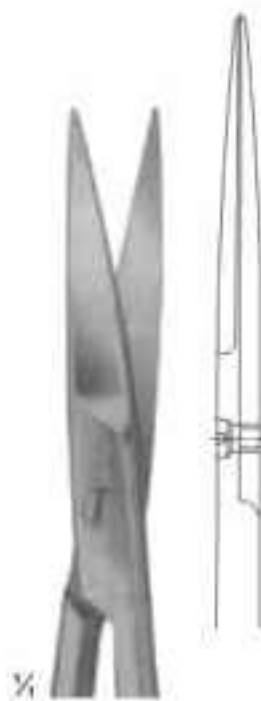

1/2

**03-141**

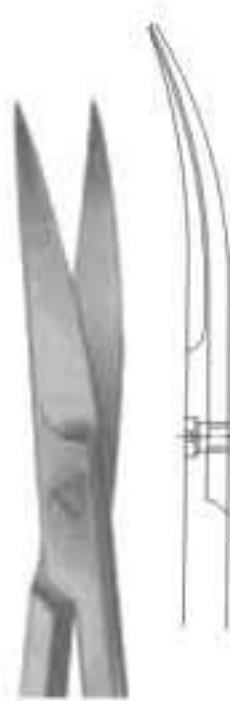

**03-142**

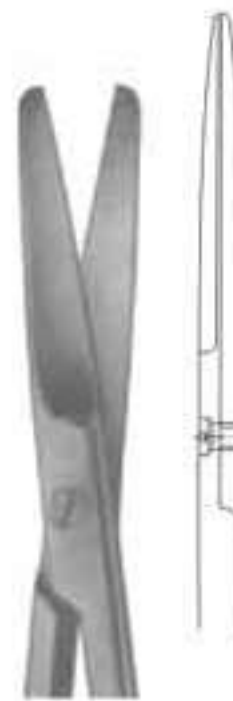

**03-143**



**03-144**

# Surgical Scissors



**03-145 - 153 (Standard types)**  
 03-145 ( 105 mm )  
 03-146 ( 115 mm )  
 03-147 ( 130 mm )  
 03-148 ( 145 mm )  
 03-149 ( 150 mm )  
 03-150 ( 165 mm )  
 03-151 ( 175 mm )  
 03-152 ( 185 mm )  
 03-153 ( 200 mm )

**03-145**      **03-153**  
 Size: 105 mm    Size: 200 mm



**03-154 - 160 (Standard types)**  
 03-154 ( 115 mm )  
 03-155 ( 130 mm )  
 03-156 ( 145 mm )  
 03-157 ( 150 mm )  
 03-158 ( 165 mm )  
 03-159 ( 175 mm )  
 03-160 ( 185 mm )

**03-154**      **03-160**  
 Size: 115 mm    Size: 185 mm

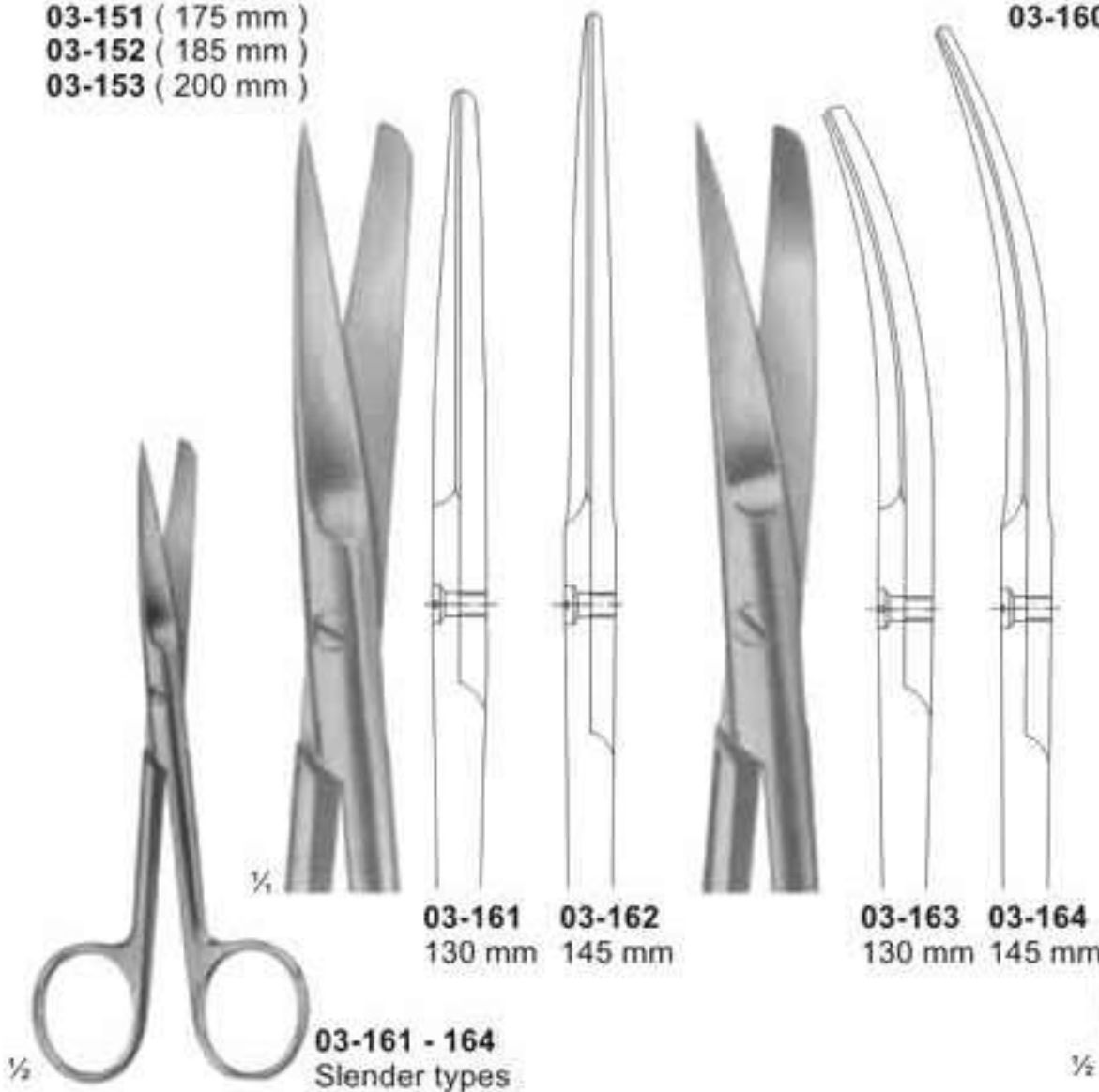

**03-161 - 164**  
 Slender types

**03-161**    **03-162**  
 130 mm    145 mm

**03-163**    **03-164**  
 130 mm    145 mm

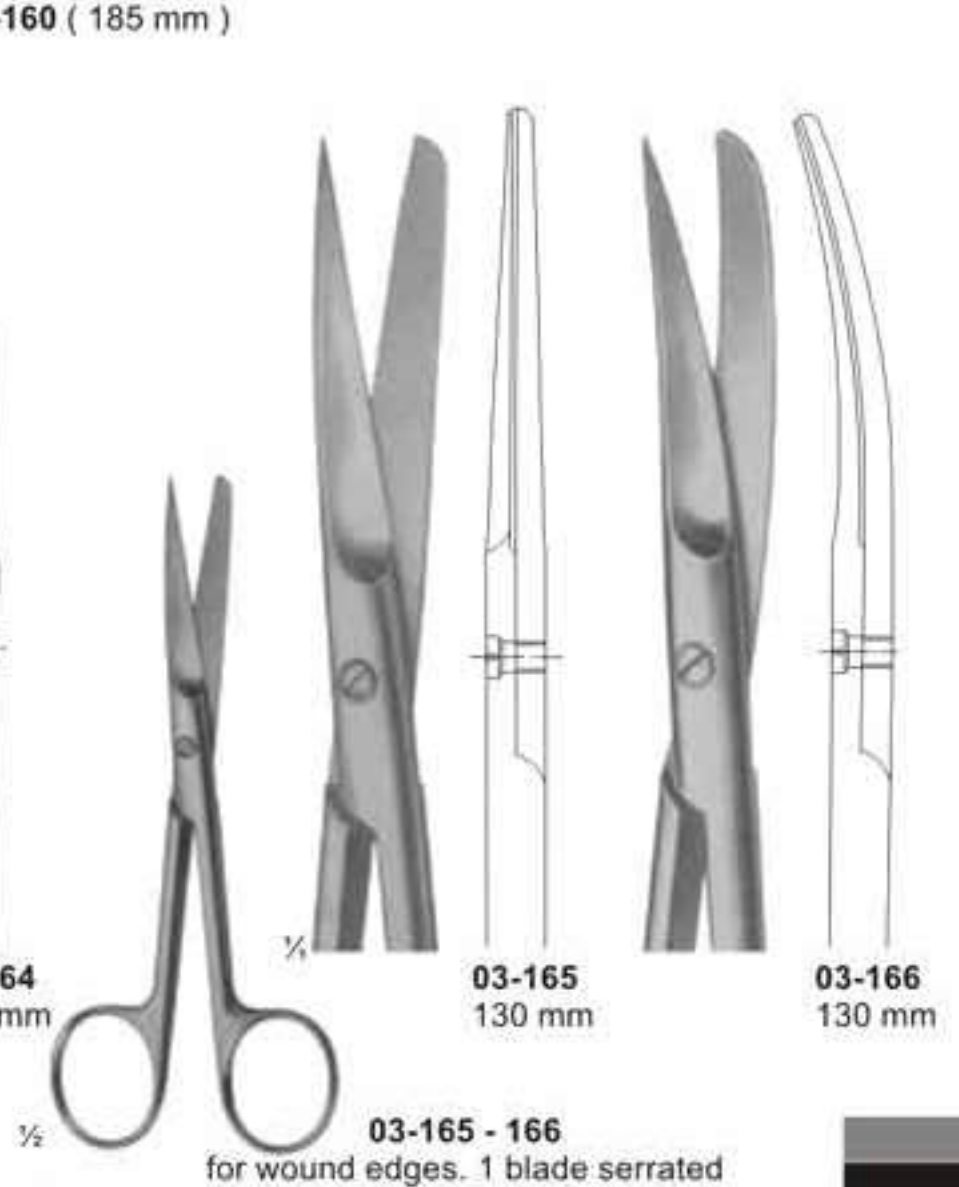

**03-165 - 166**  
 for wound edges. 1 blade serrated

**03-165**  
 130 mm

**03-166**  
 130 mm

# Surgical Scissors



**03-167 - 169**  
DEAVER  
with flat lock

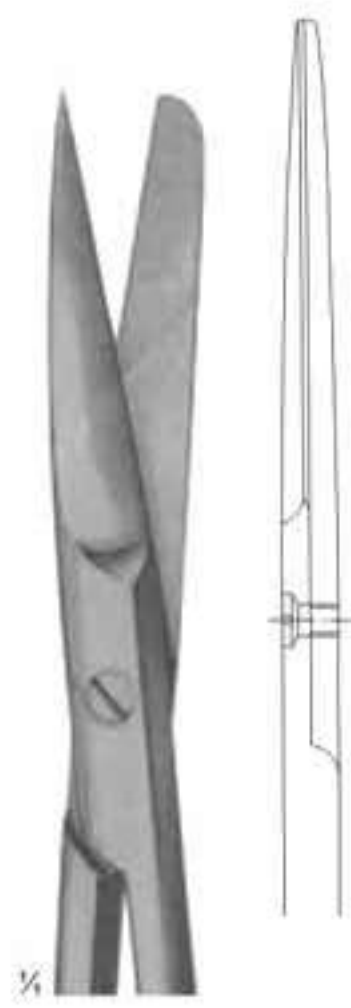

**03-167**  
Size: 145 mm

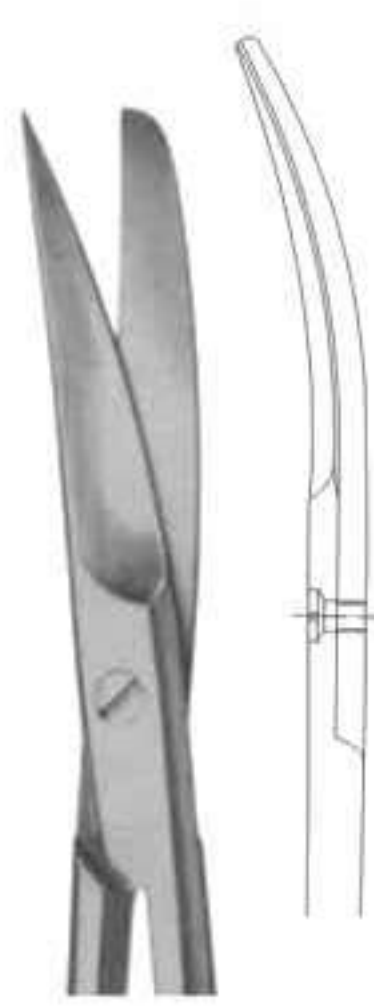

**03-168**  
Size: 145 mm

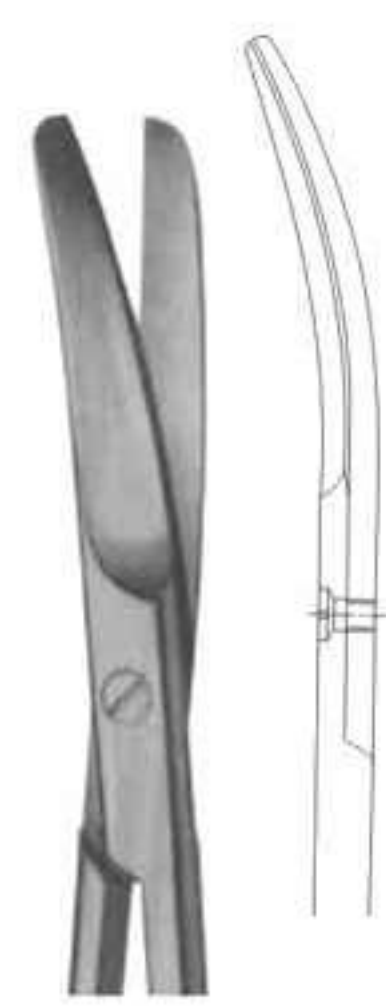

**03-169**  
Size: 145 mm



**03-170 - 172**  
Incision scissors



**03-170**  
Size: 130 mm



**03-171**  
Size: 145 mm

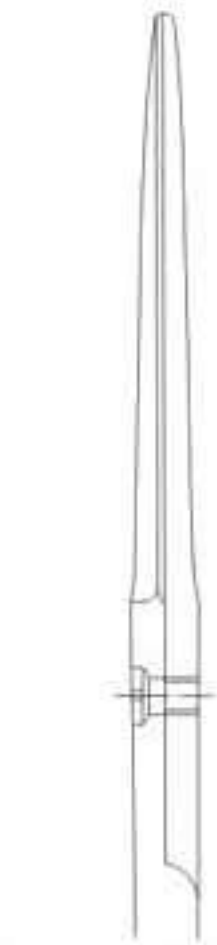

**03-172**  
Size: 165 mm



**03-173**  
SYSTRUNK  
Nail splitting scissors



**03-173**  
Size: 130 mm



# Dissecting Scissors

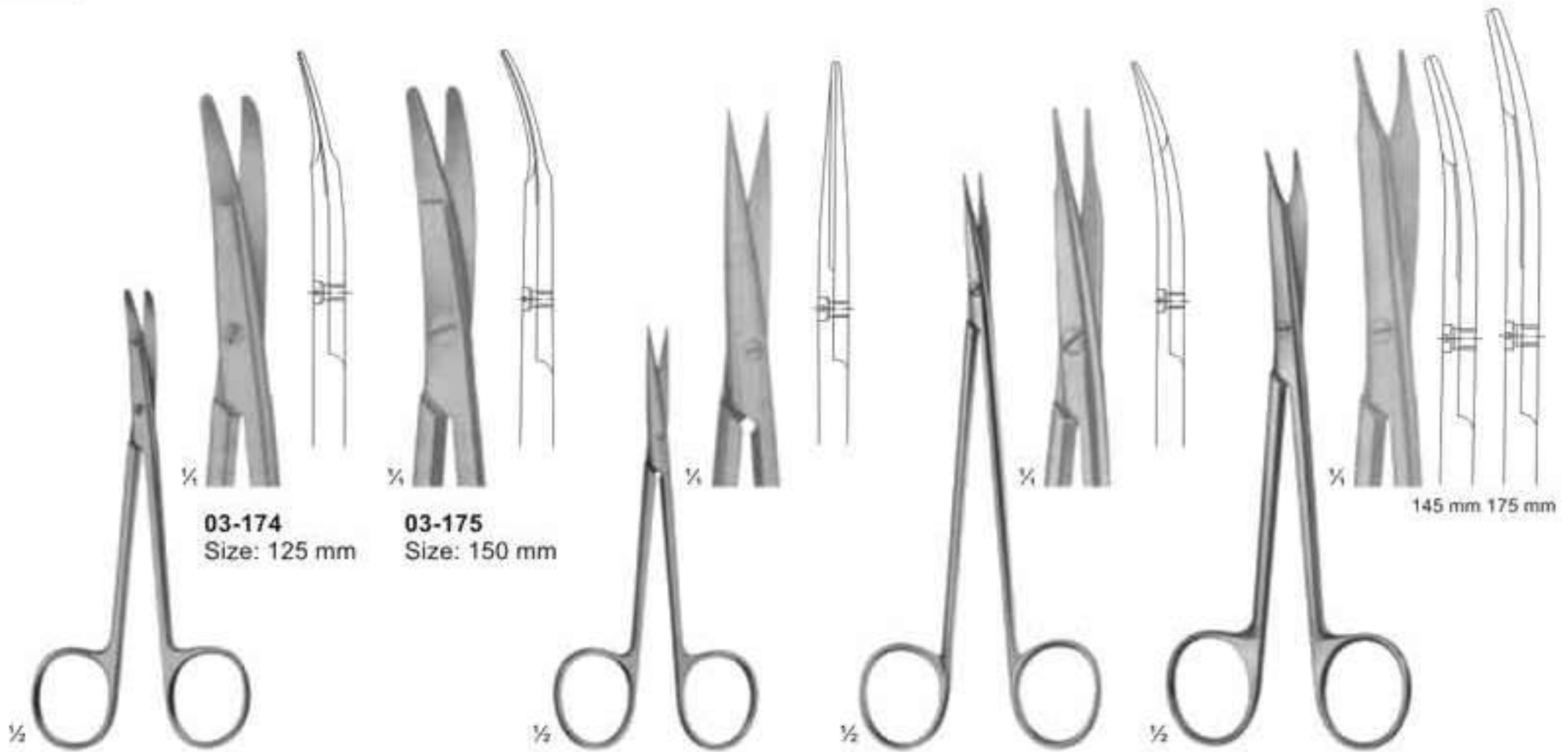

**03-174 - 175**  
**KILNER**  
Special flat points for dissecting and undermining the skin

**03-176**  
**KILNER**  
Fine dissecting scissors  
Size: 115 mm

**03-177**  
**JAMESON**  
Dissecting scissors  
Size: 150 mm

**03-178**  
**REYNOLDS**  
Dissecting scissors  
Size: 145 - 175 mm

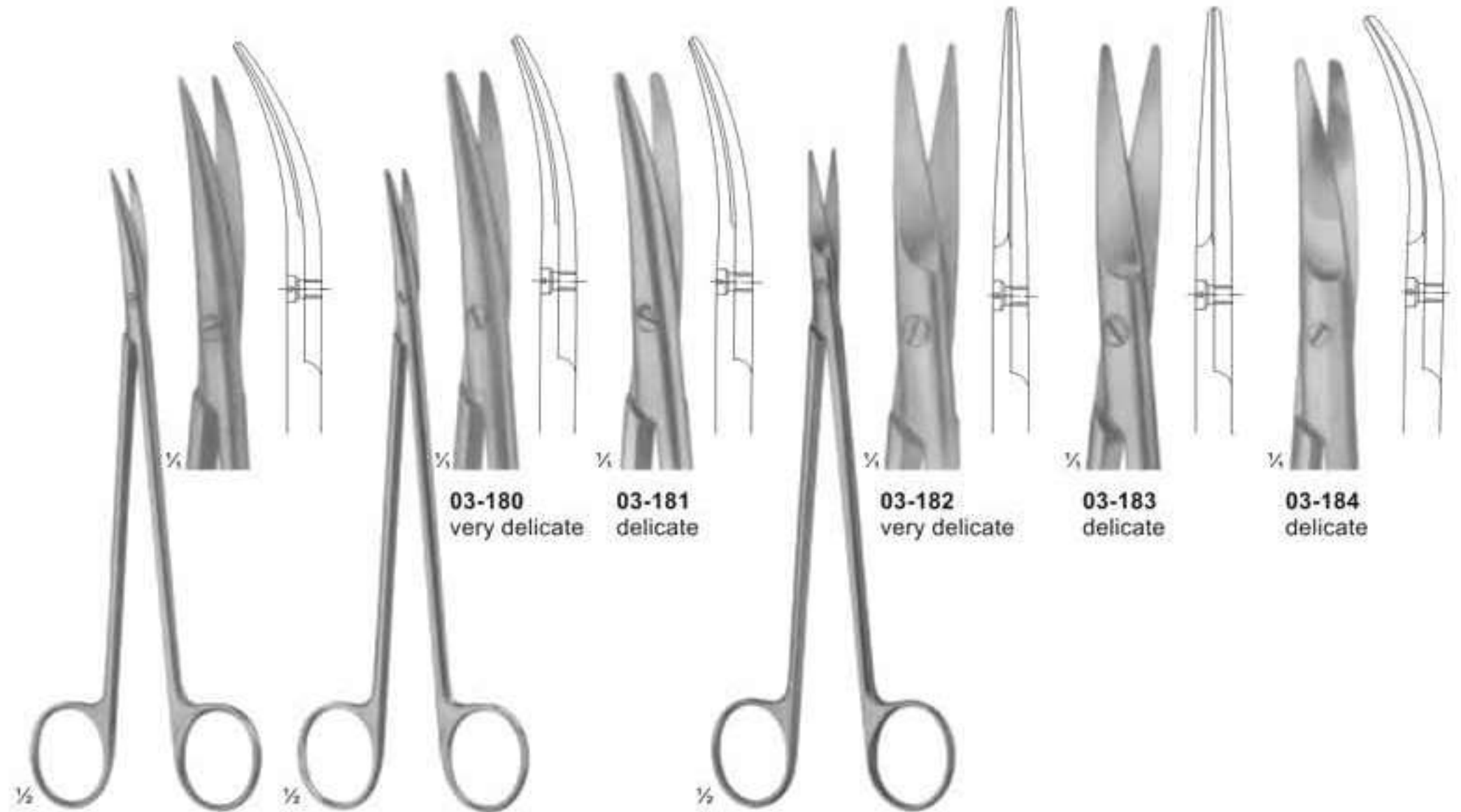

**03-179**  
**DE BAKEY**  
Arteriotomy scissors  
Size: 175 mm

**03-180 - 181**  
**TOENNIS ADSON**  
Dissecting scissors  
Size: 175 mm

**03-182 - 184**  
**TOENNIS**  
Dissecting scissors  
Size: 180 mm

## Dissecting Scissors

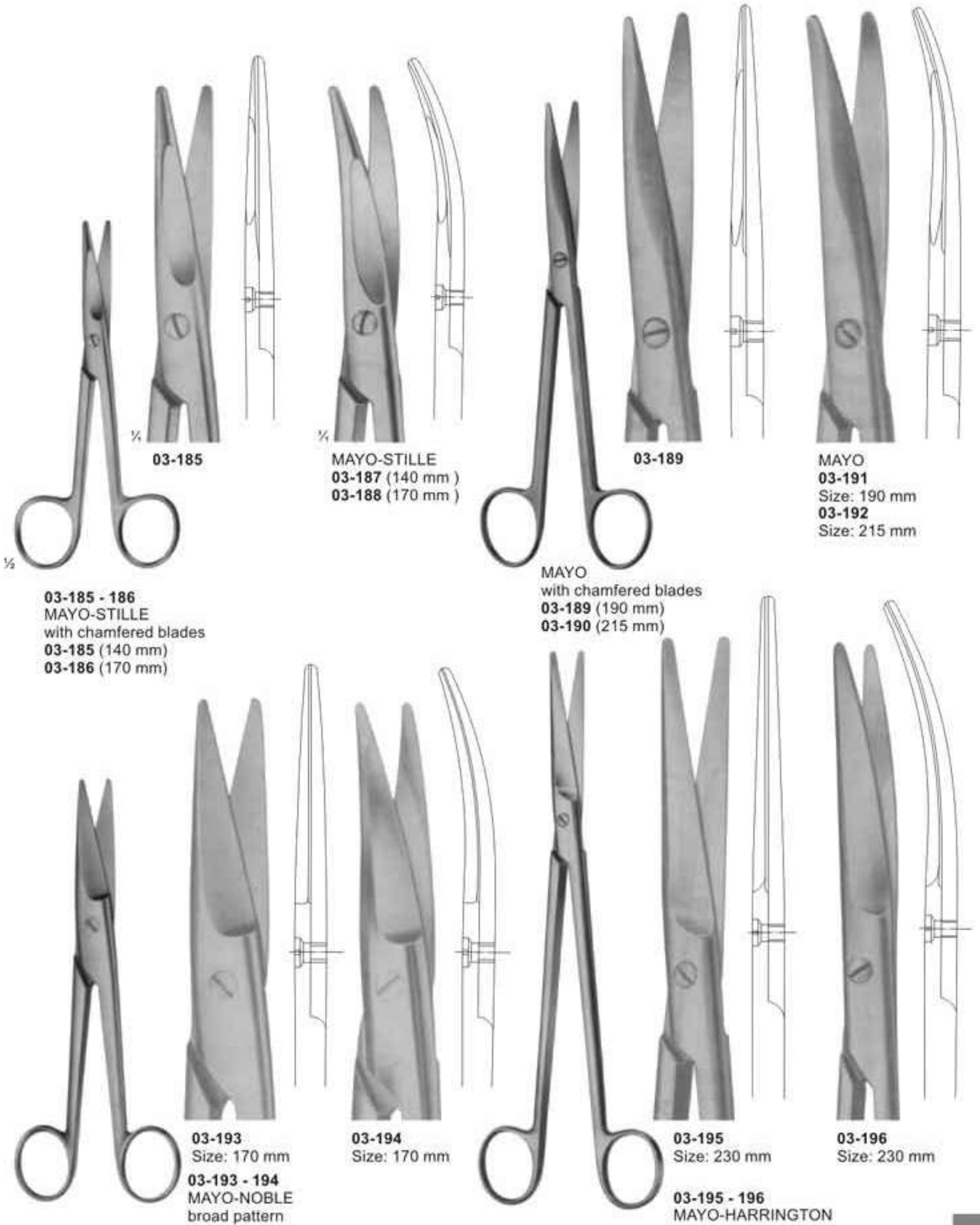

## Scissors for Cardiovascular and Neuro-Surgery



**03-197**  
OLIVECRONA  
Dura scissors



**03-198**  
STRULLY  
pointed  
Size: 220 mm

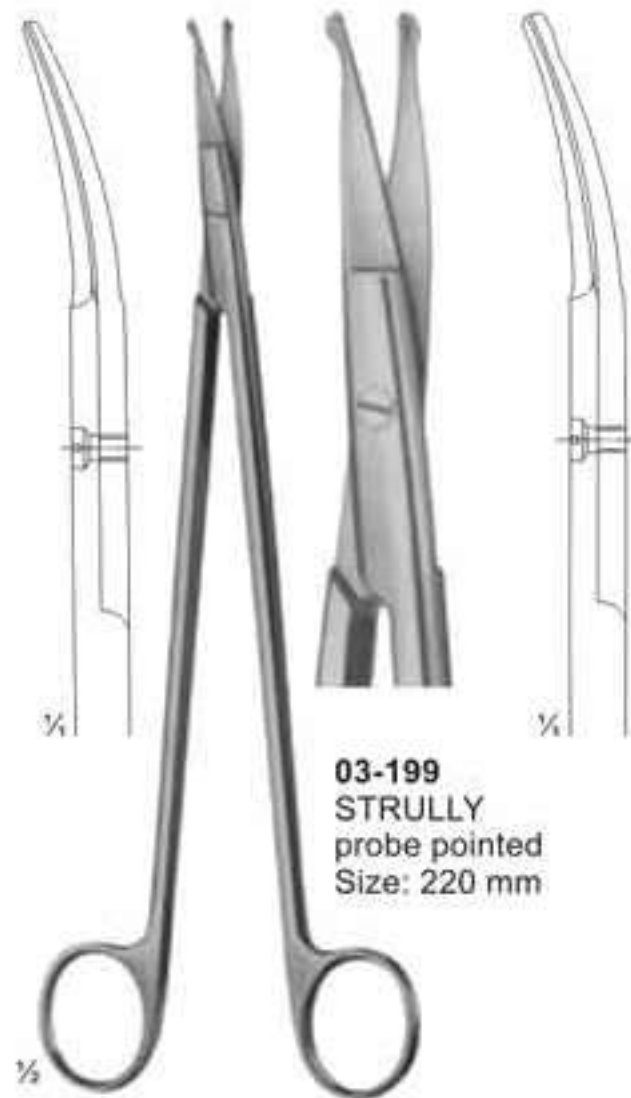

**03-199**  
STRULLY  
probe pointed  
Size: 220 mm

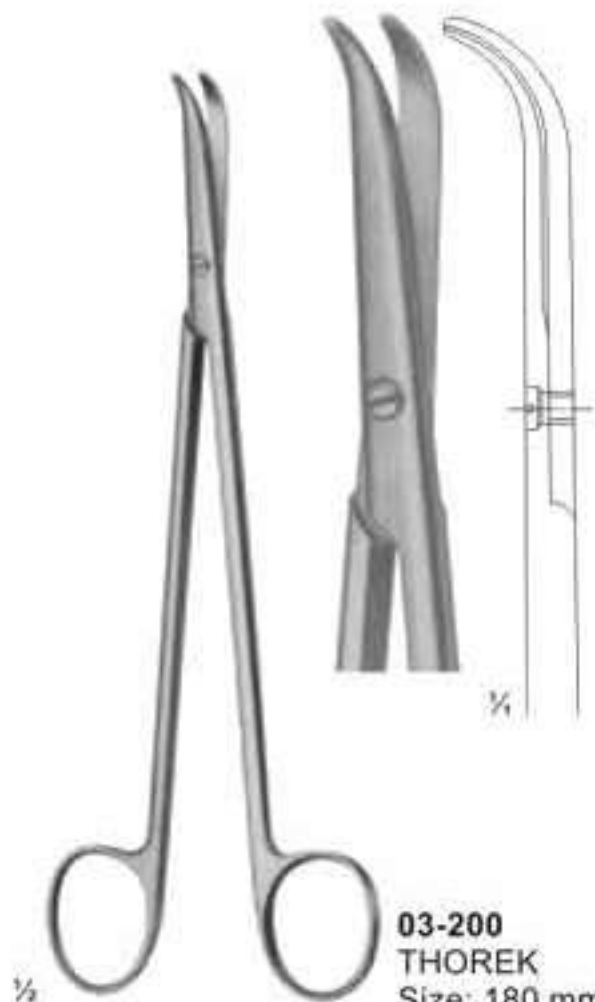

**03-200**  
THOREK  
Size: 180 mm

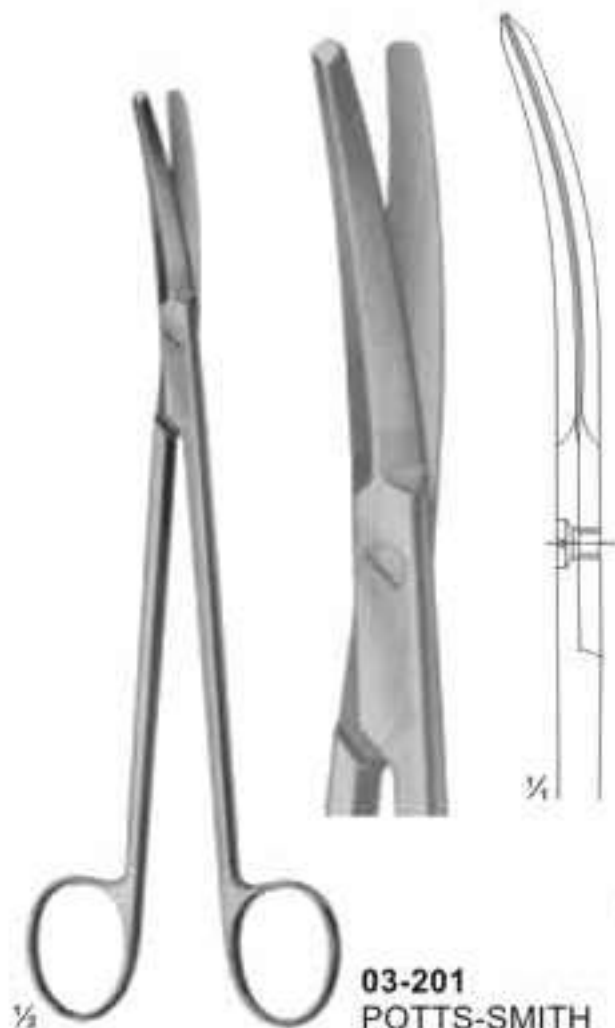

**03-201**  
POTTS-SMITH  
Size: 190 mm

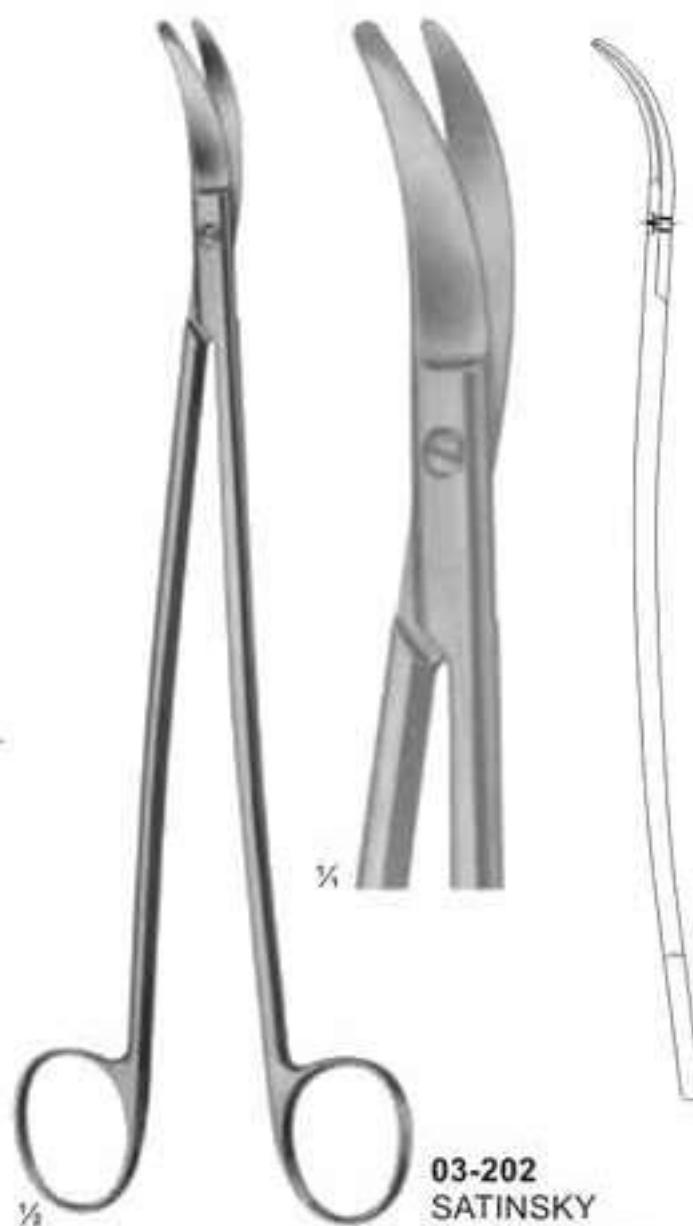

**03-202**  
SATINSKY  
Size: 245 mm

## Delicate, Nasal and Tonsil Scissors

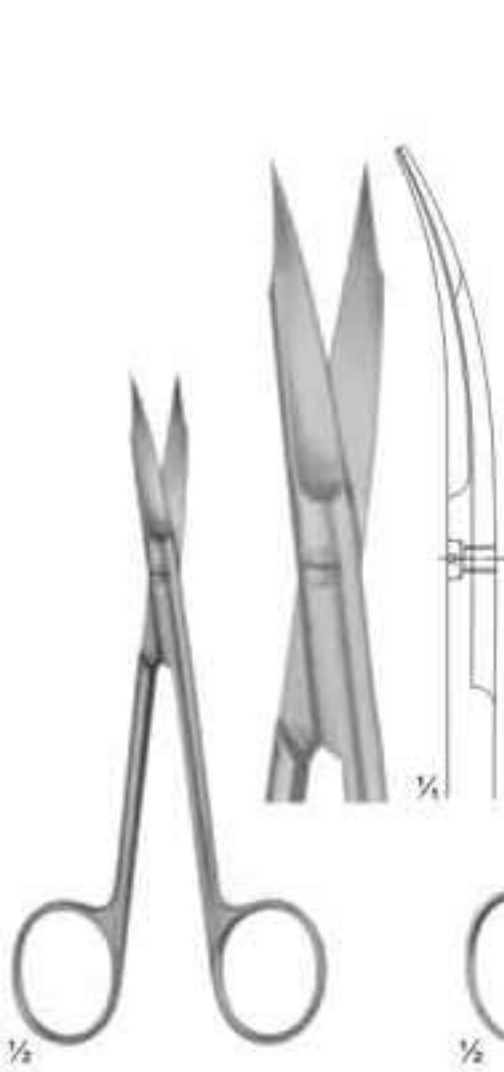

**03-203**  
1 finely toothed blade  
Size: 130 mm

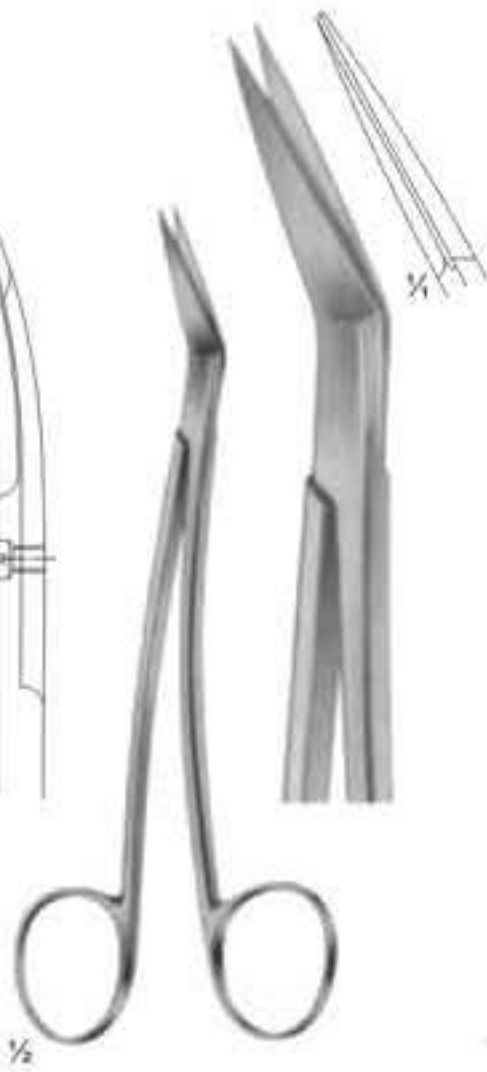

**03-204**  
LOCKLIN  
curved sideways,  
1 toothed blade  
Size: 155 mm



**03-205**  
FOMON  
blades serrated  
Size: 145 mm

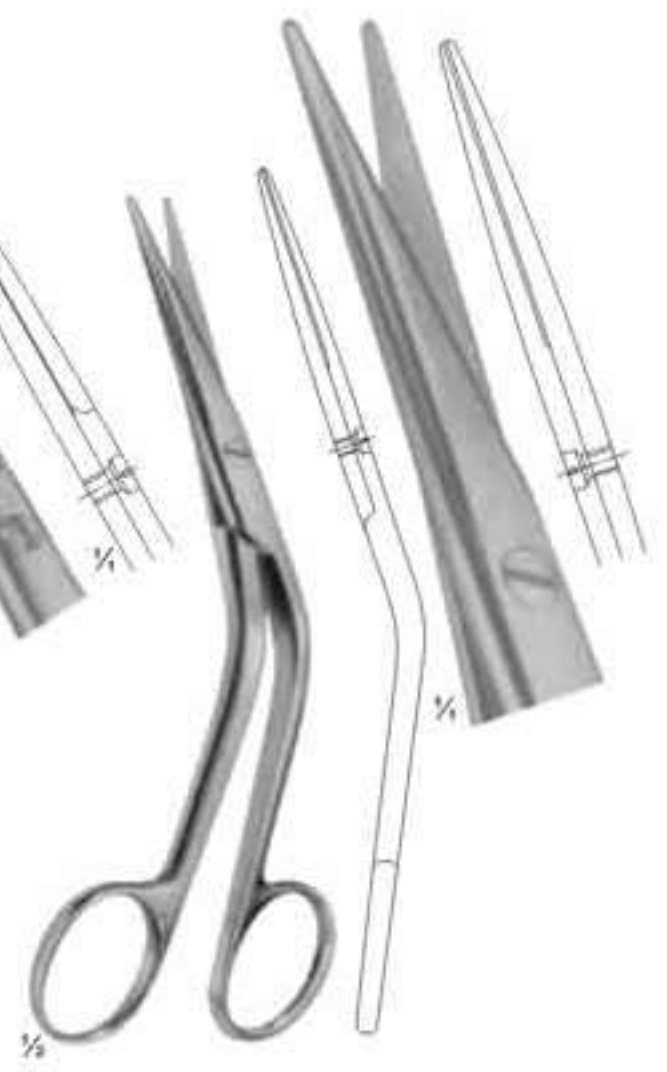

**03-206**  
COTTLE  
Size: 165 mm



**03-207**  
HEYMANN-KNIGHT  
Size: 175 mm

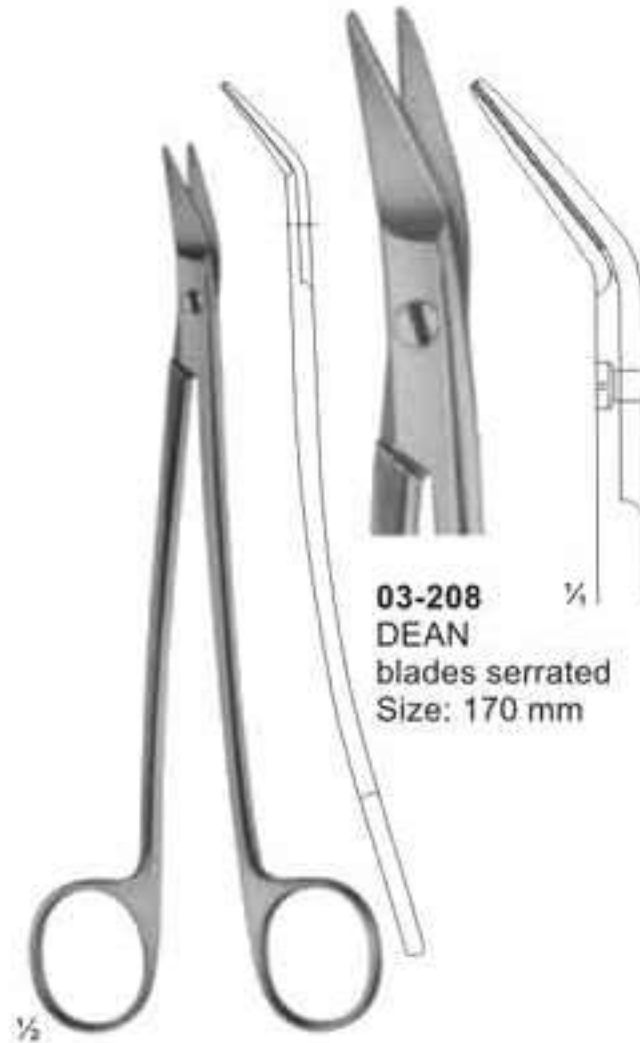

**03-208**  
DEAN  
blades serrated  
Size: 170 mm

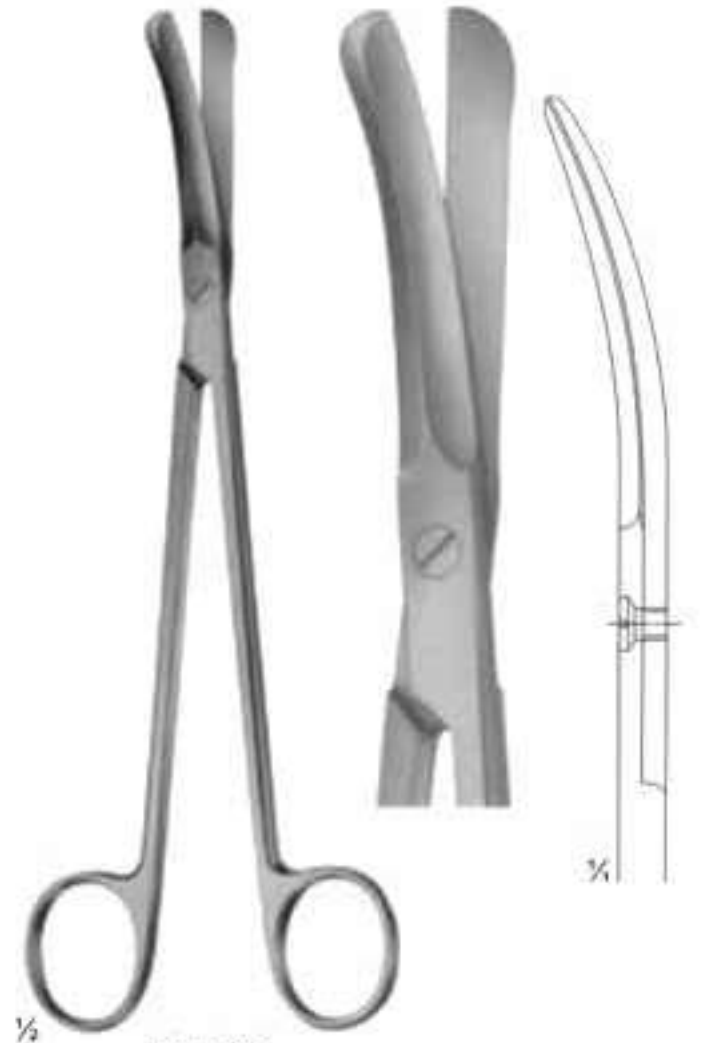

**03-209**  
GOOD  
Size: 195 mm

# Bone Shears

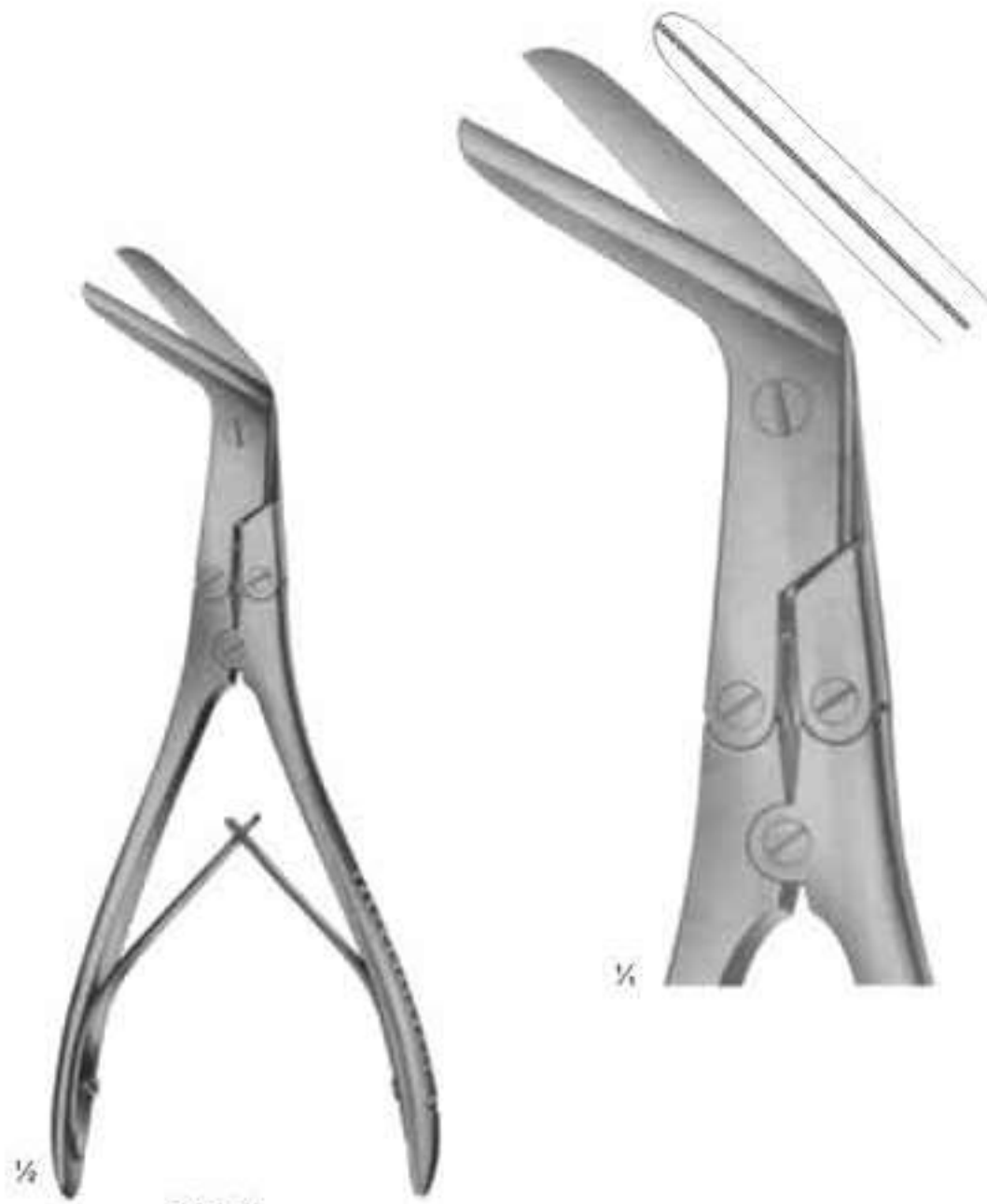

**03-210**  
KILLIAN  
Size: 200 mm



**03-211 - 03-212**

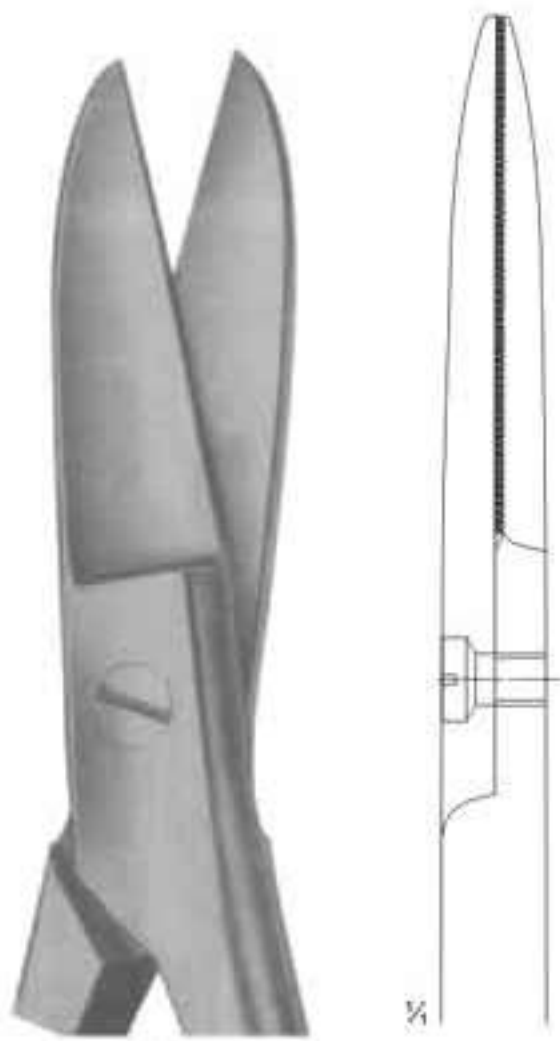

**03-211**  
195 mm

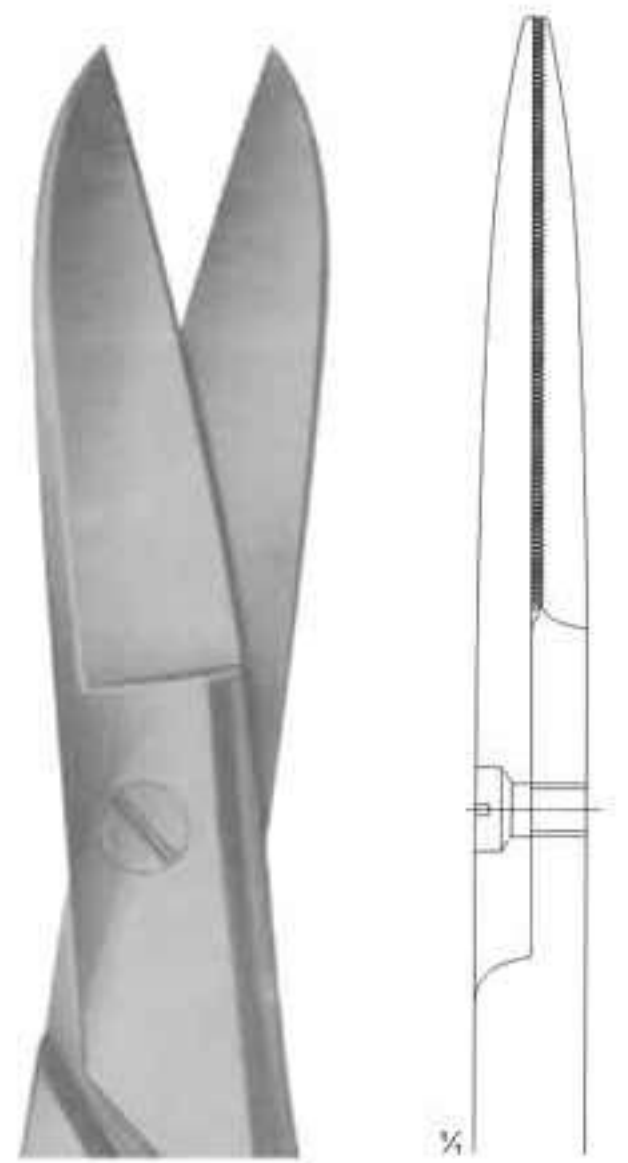

**03-212**  
225 mm

Scissors for deep operations and  
for Gynaecology

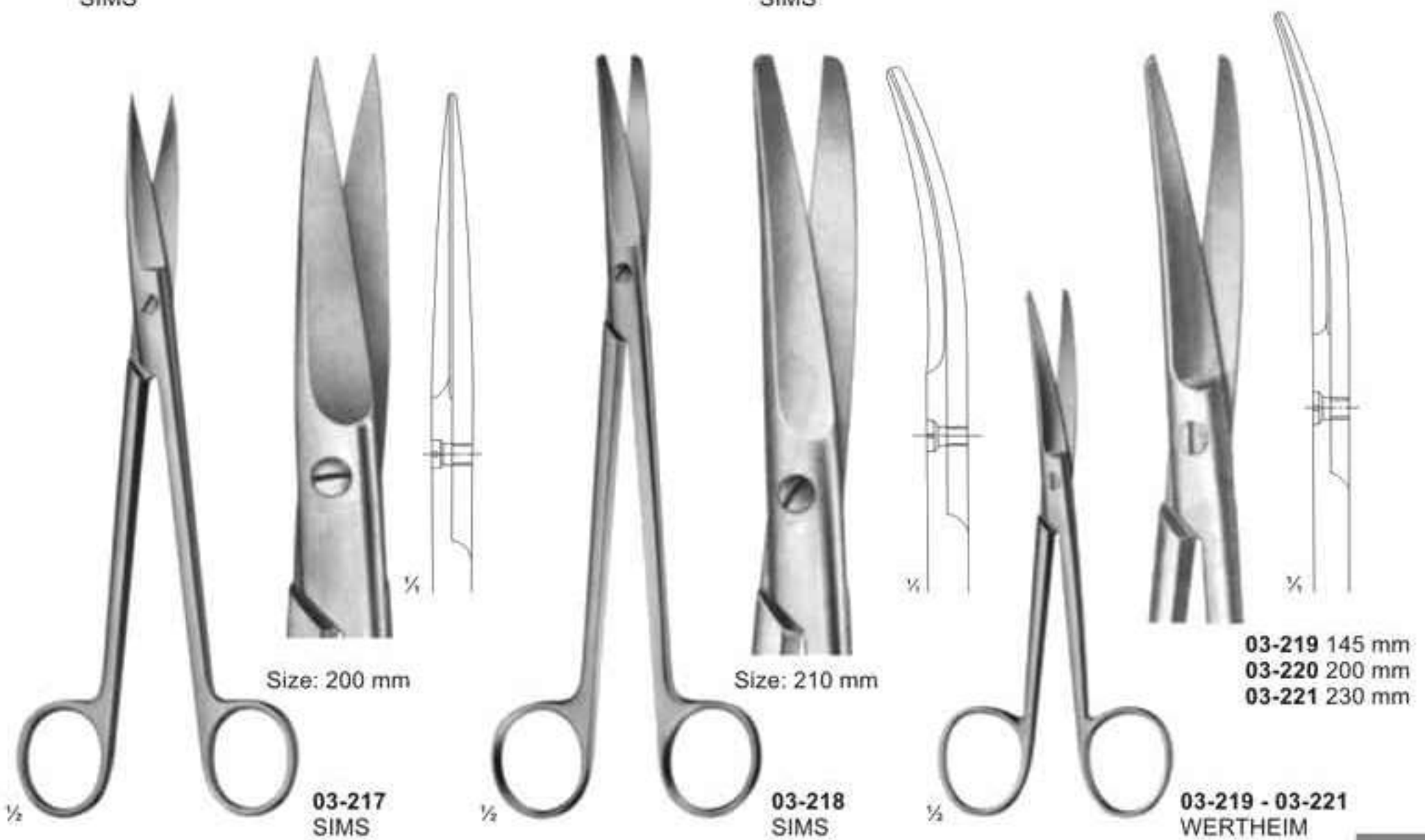
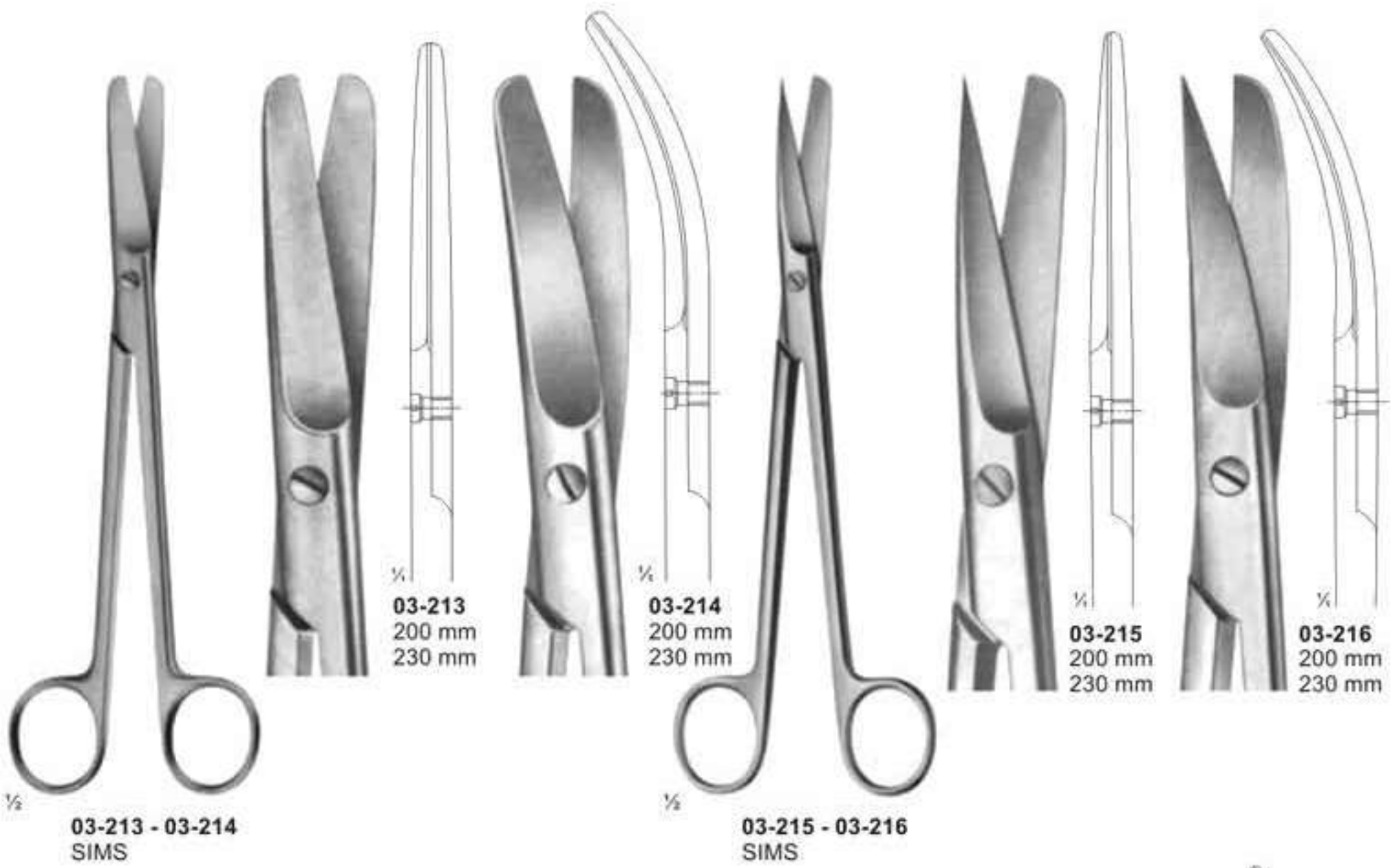

## Scissors for Obstetrics

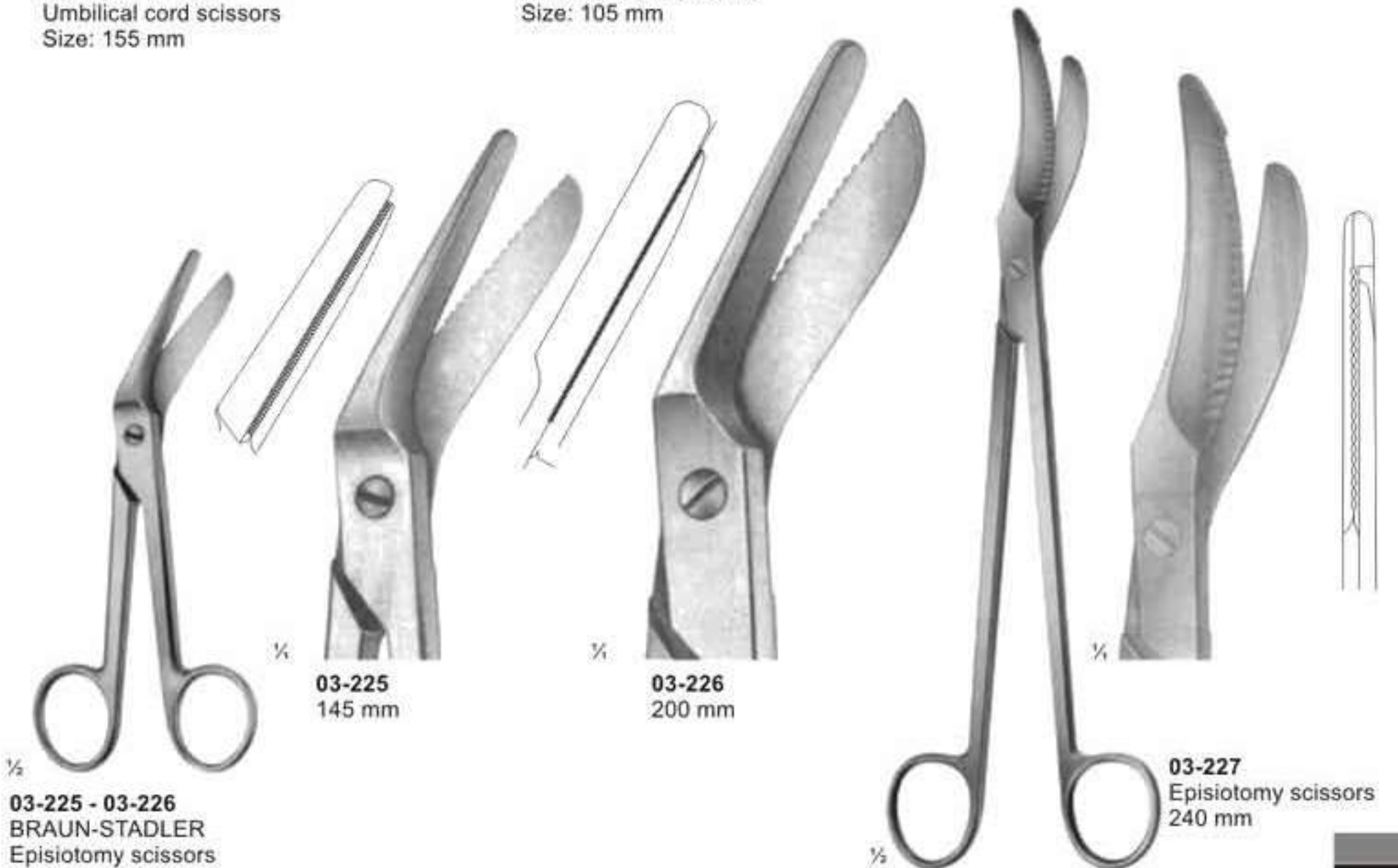

## Wire and Plate Scissors

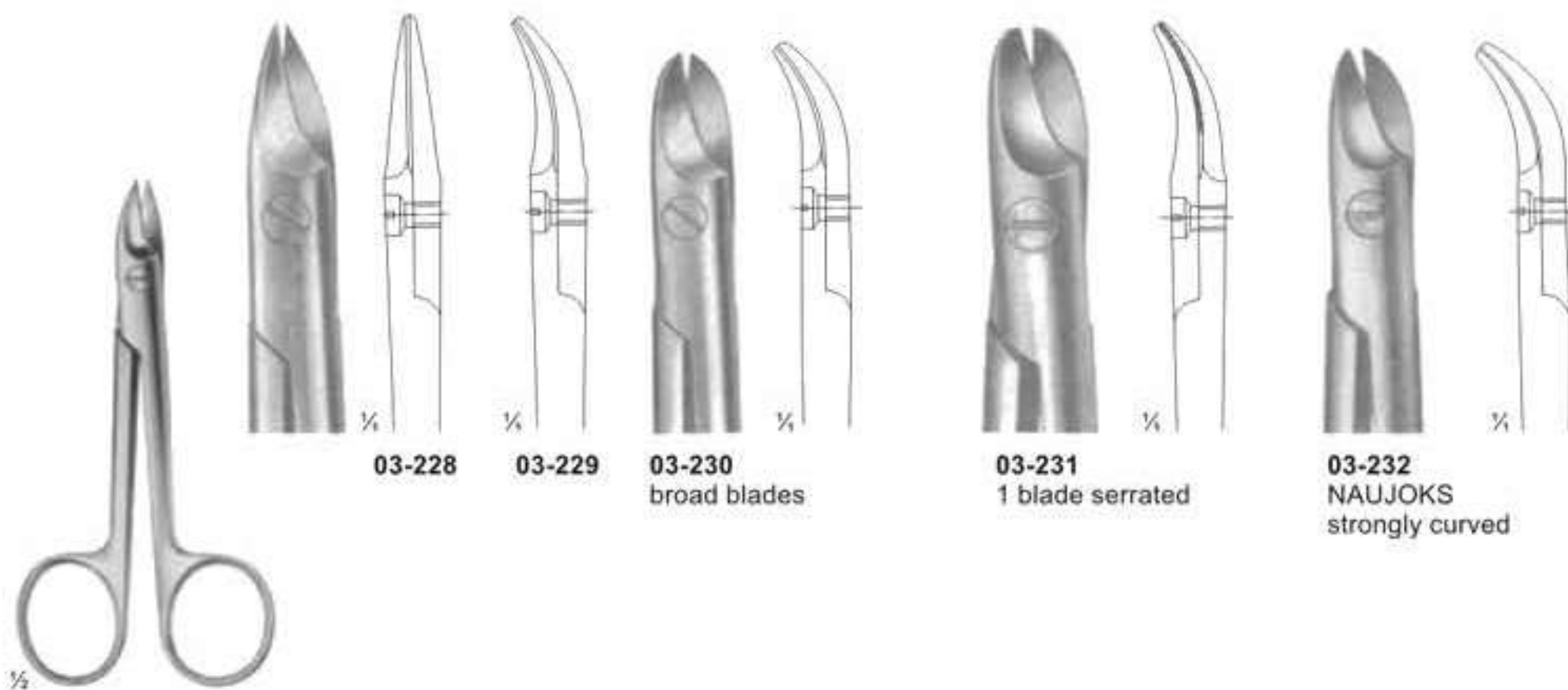

03-228

03-229

03-230  
broad blades

03-231  
1 blade serrated

03-232  
NAUJOKS  
strongly curved

03-228 - 03-232  
BEEBE  
Size: 110 mm

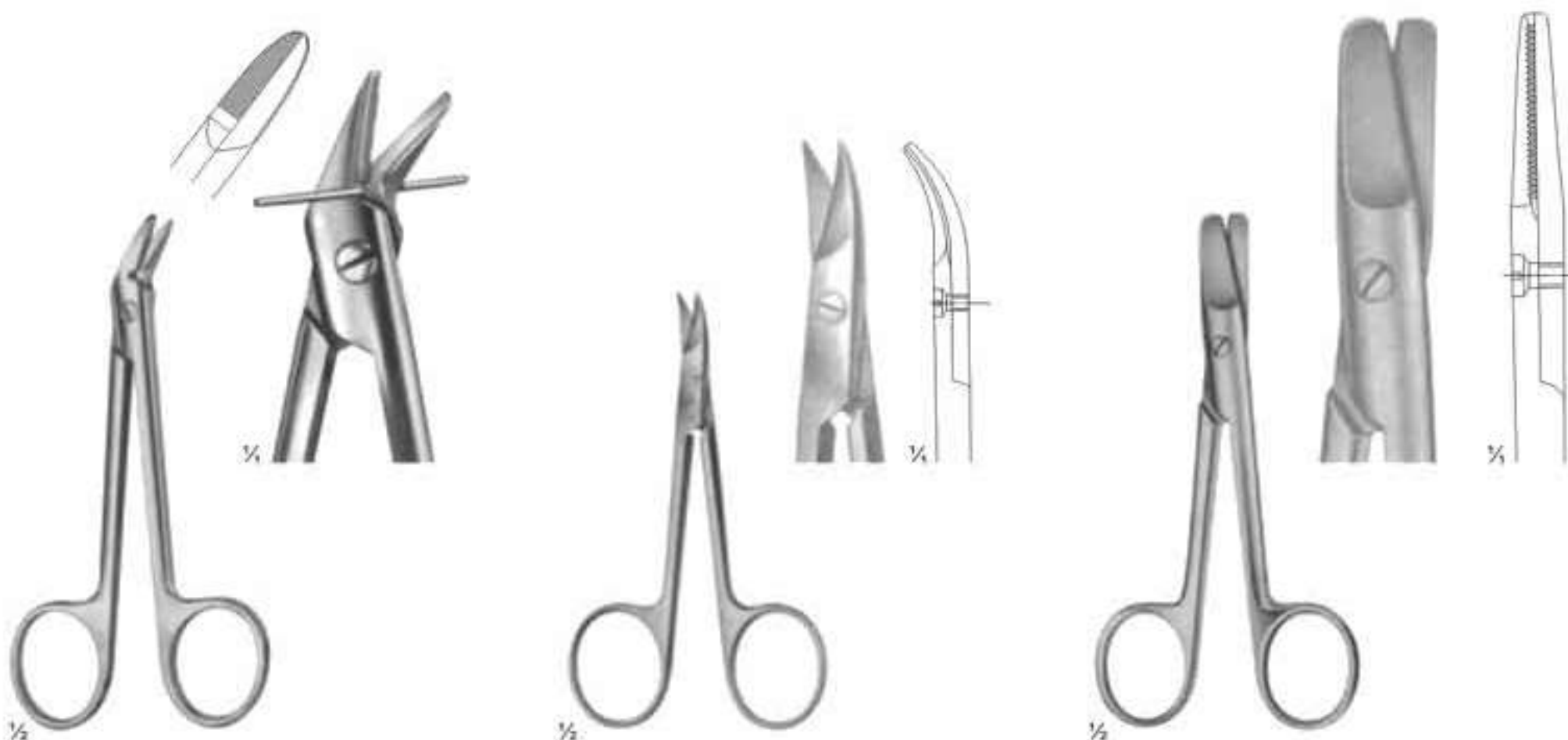

03-233  
1 blade serrated  
Size: 120 mm

03-234  
STRACK  
Size: 100 mm

03-235  
HARVEY  
blades serrated  
Size: 125 mm



## Bandage and Cloth Scissors



**03-236**  
Universal bandage and cloth scissors,  
with toothed edges  
180 mm



**03-237**  
LISTER  
Universal bandage and cloth scissors,  
with toothed edges  
Size: 145 mm

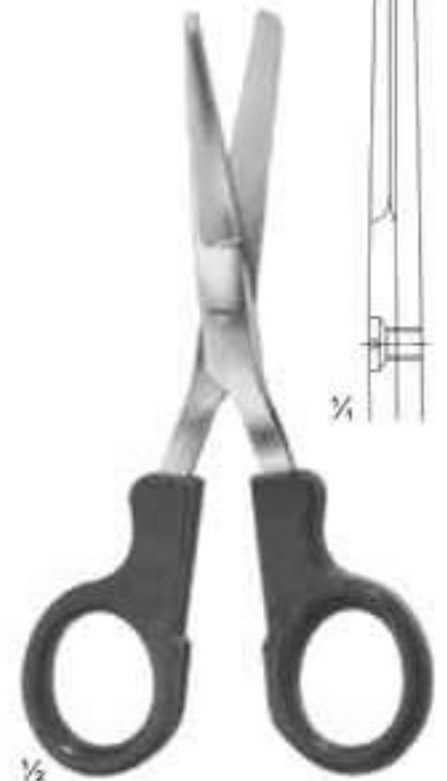
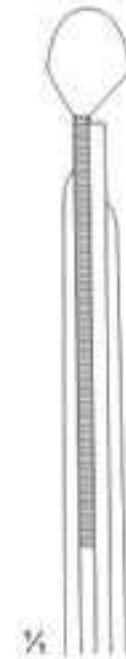

**03-238**  
LISTER  
Nurse's scissors  
Size: 145 mm

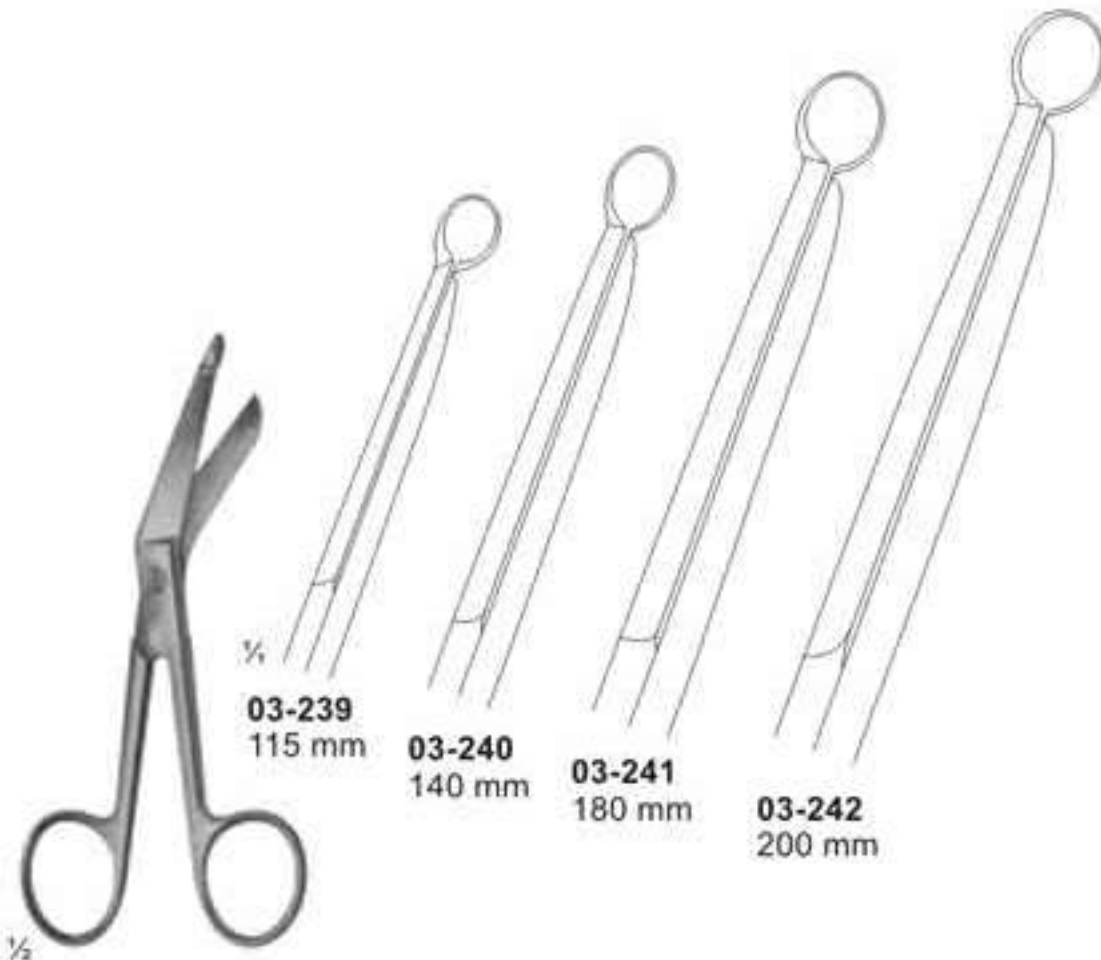

**03-239 - 03-242**  
LISTER

**03-239**  
115 mm

**03-240**  
140 mm

**03-241**  
180 mm

**03-242**  
200 mm

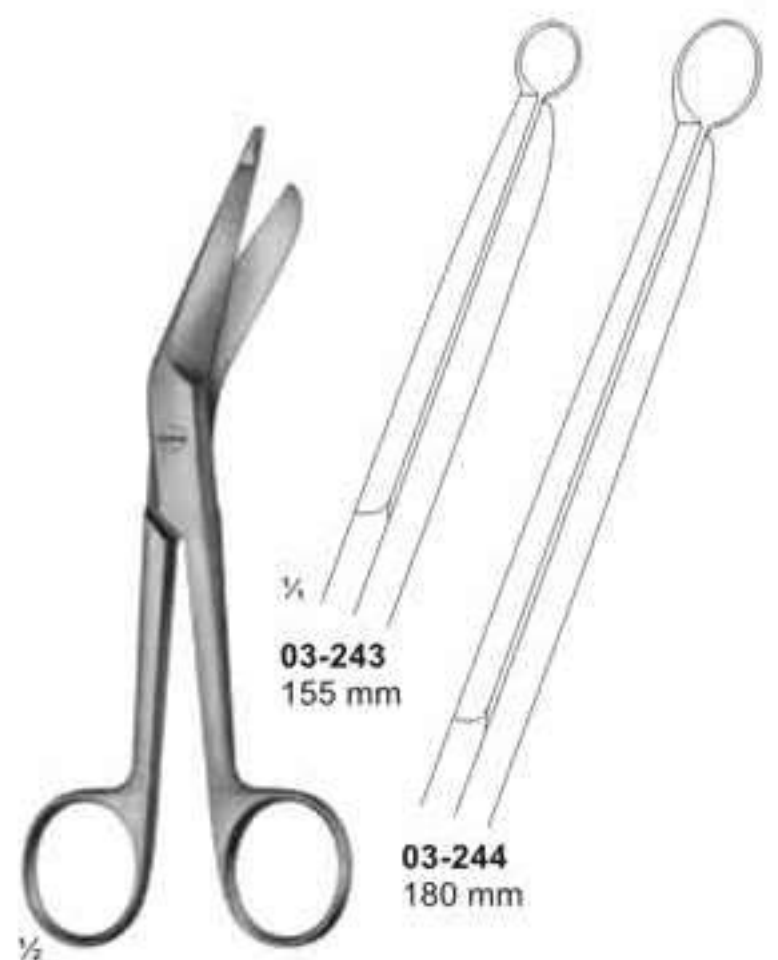

**03-243 - 03-244**  
LISTER

**03-243**  
155 mm

**03-244**  
180 mm

## Bandage-, Cloth-, and Plaster Scissors



**03-245**  
CLOTH SCISSORS  
205 mm

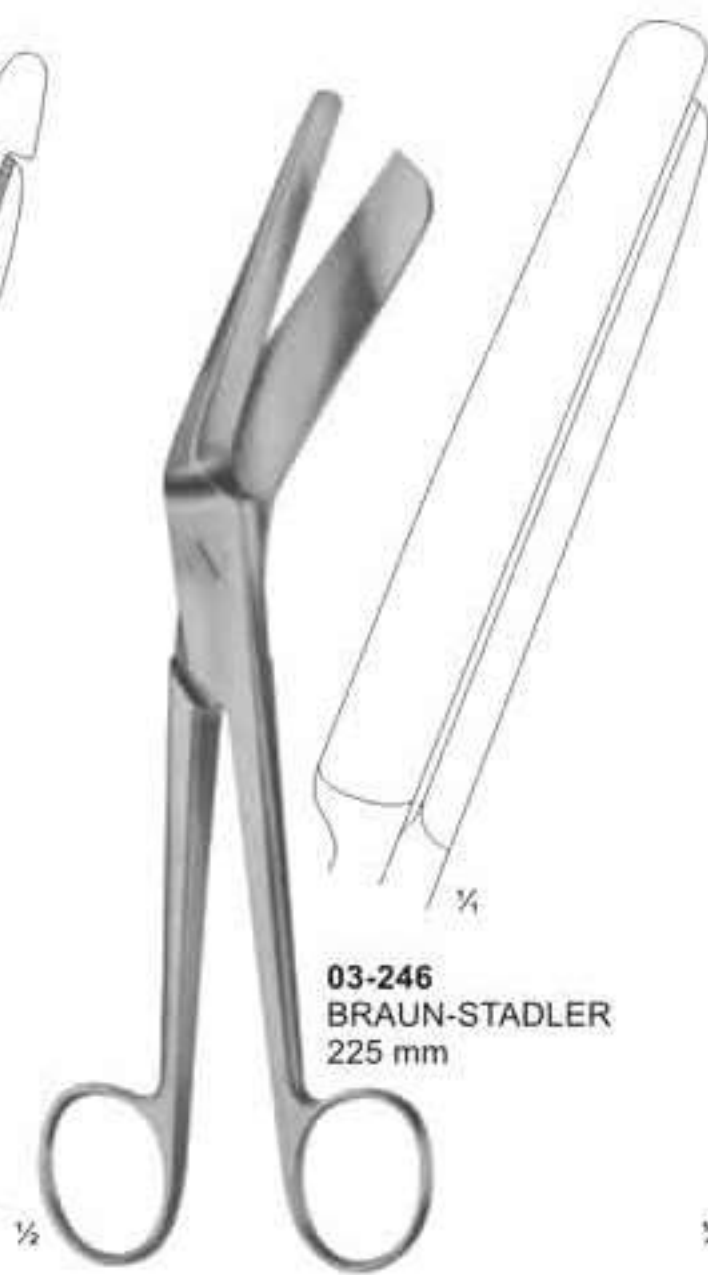

**03-246**  
BRAUN-STADLER  
225 mm



**03-247**  
SEUTIN  
230 mm

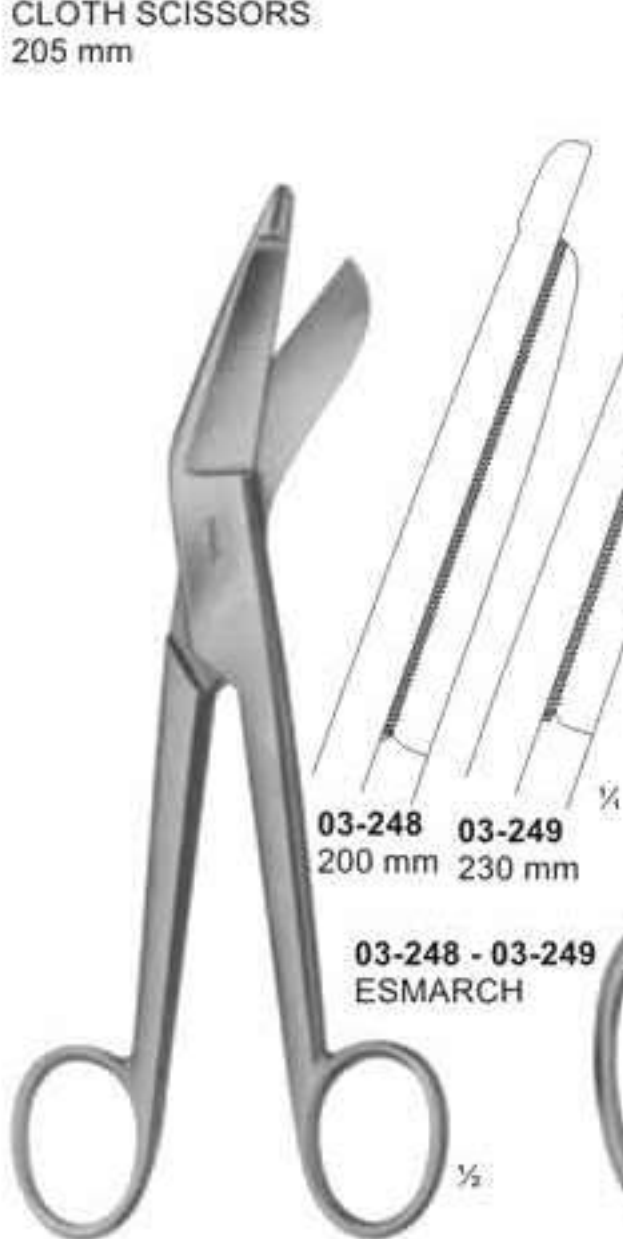

**03-248** 200 mm  
**03-249** 230 mm

**03-248 - 03-249**  
ESMARCH

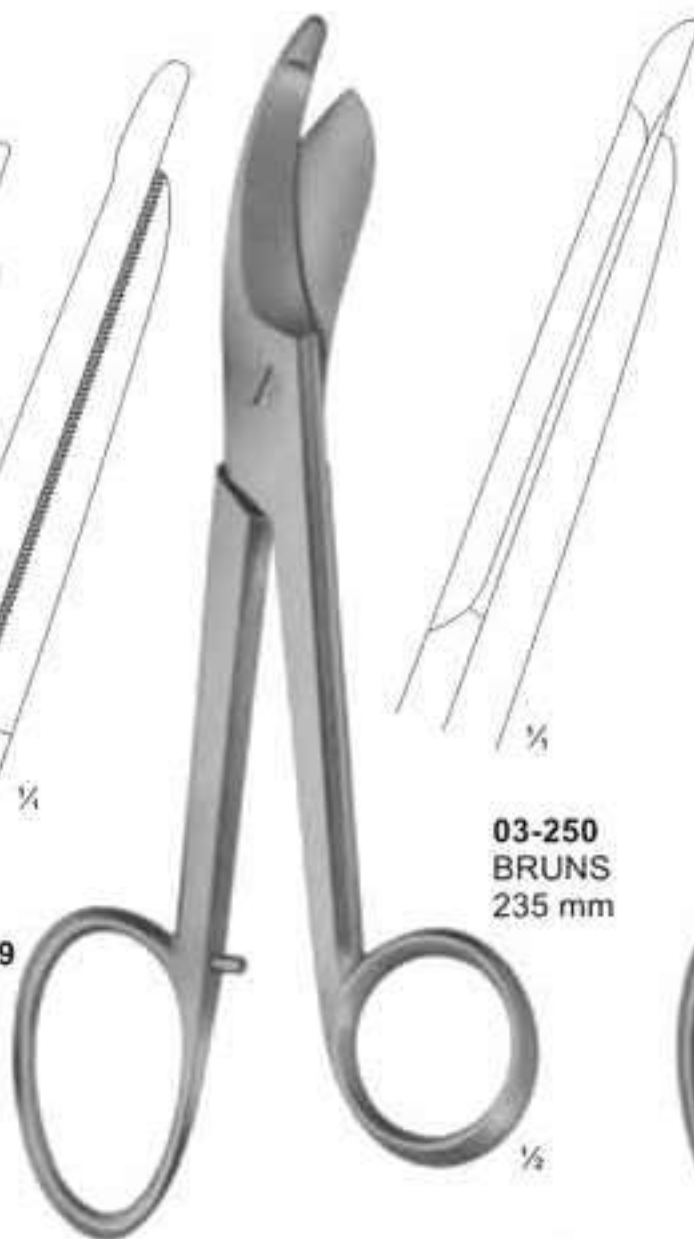

**03-250**  
BRUNS  
235 mm

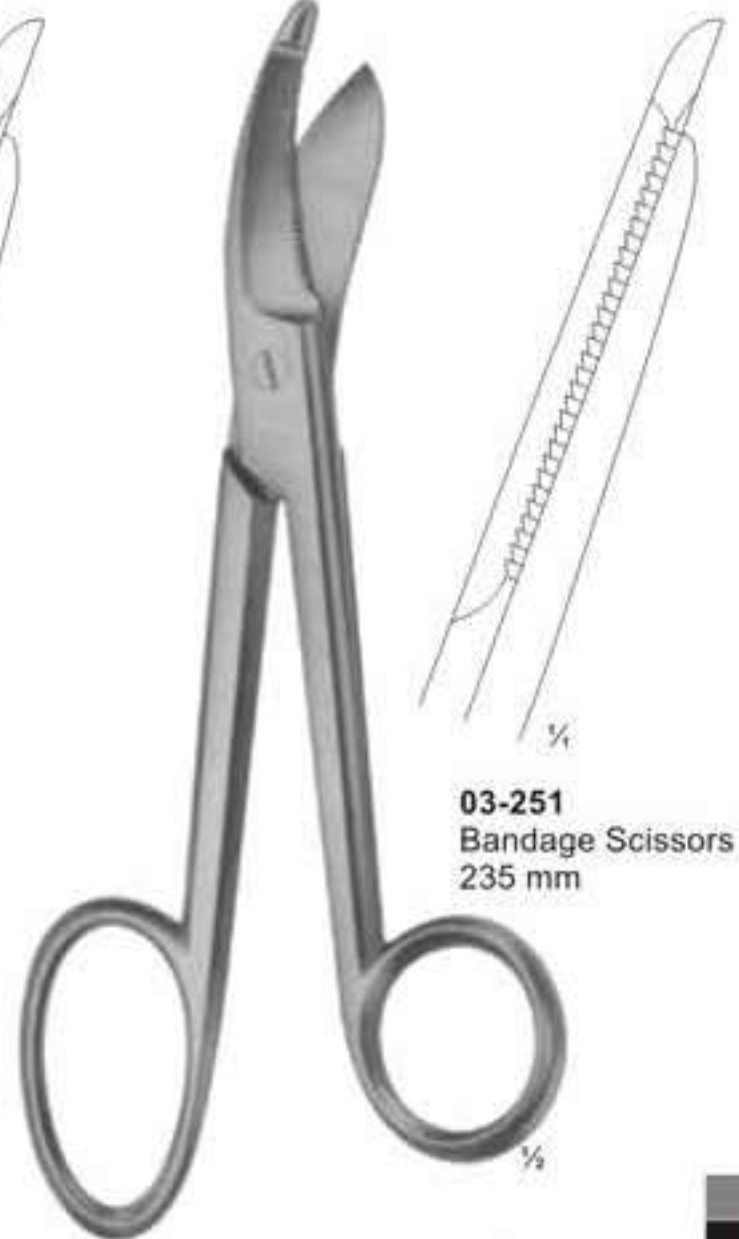

**03-251**  
Bandage Scissors  
235 mm

## Forceps for grasping tissue, tumors etc.

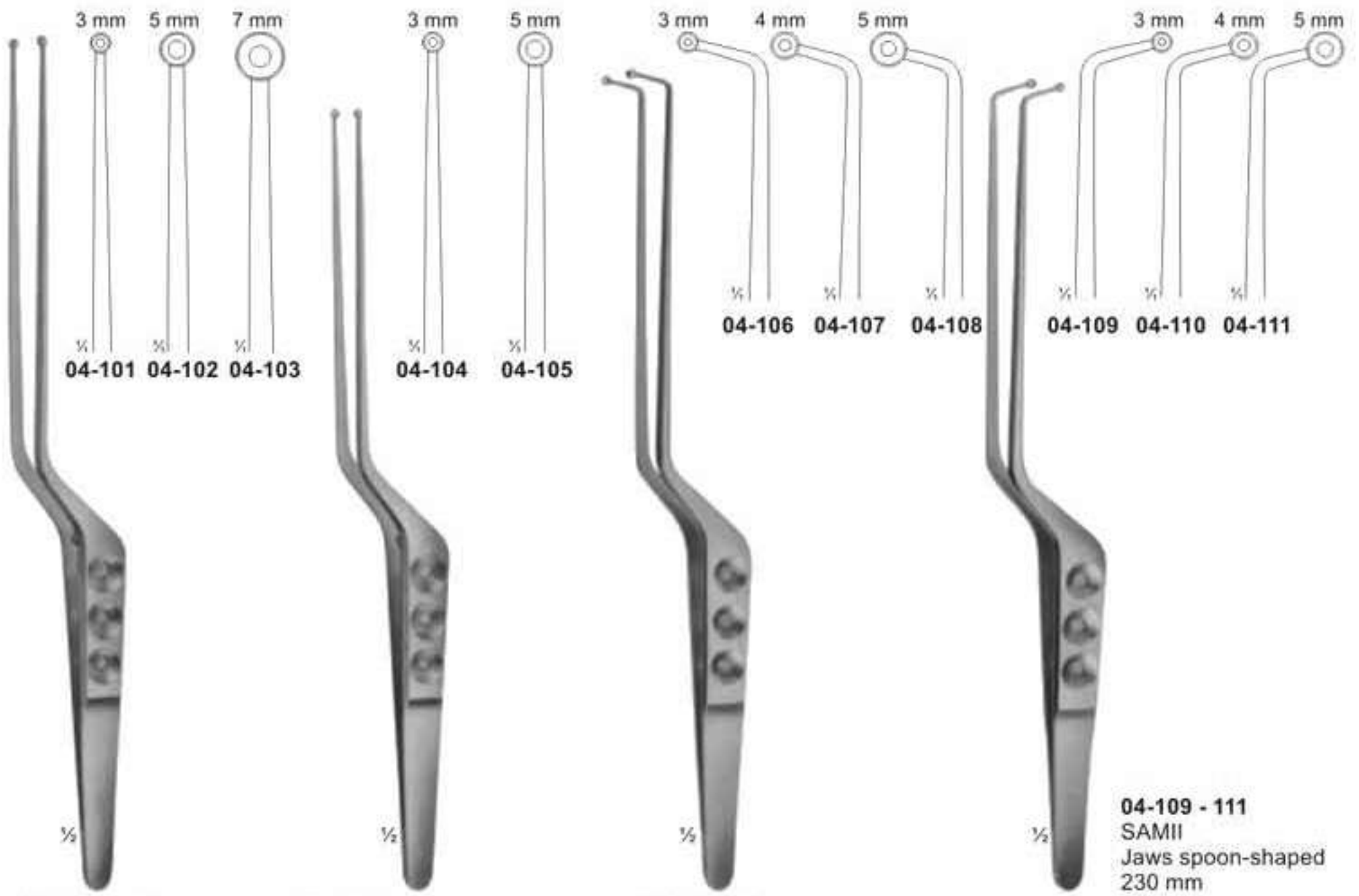

**04-101 - 103**  
YASARGIL-SAMII  
Jaws spoon-shaped  
240 mm

**04-104 - 105**  
YASARGIL  
Jaws spoon-shaped  
220 mm

**04-106 - 108**  
SAMII  
Jaws spoon-shaped  
230 mm

**04-109 - 111**  
SAMII  
Jaws spoon-shaped  
230 mm

**04-112**  
HUNT  
Tumor-and  
vessel forceps  
200 mm

**04-113**  
HUNT  
Tumor-and  
vessel forceps  
200 mm

**04-114**  
YASARGIL  
Tumor-and  
vessel forceps  
200 mm

# Delicate Dissecting, Microscopic, Sterilizing Forceps



**04-115**  
THORPE  
Corneal forceps  
120 mm



**04-116**  
MICRO-ADSON  
120 mm



**04-117**  
ADSON  
120 mm



**04-118**  
MICRO-ADSON  
150 mm



**04-119 - 121**  
100 mm



**04-119**



**04-120**



**04-121**

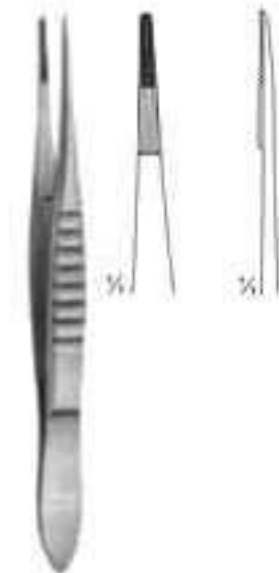

**04-122**  
BONACCOLTO  
110 mm



**04-123**  
115 mm



**04-124 - 133**

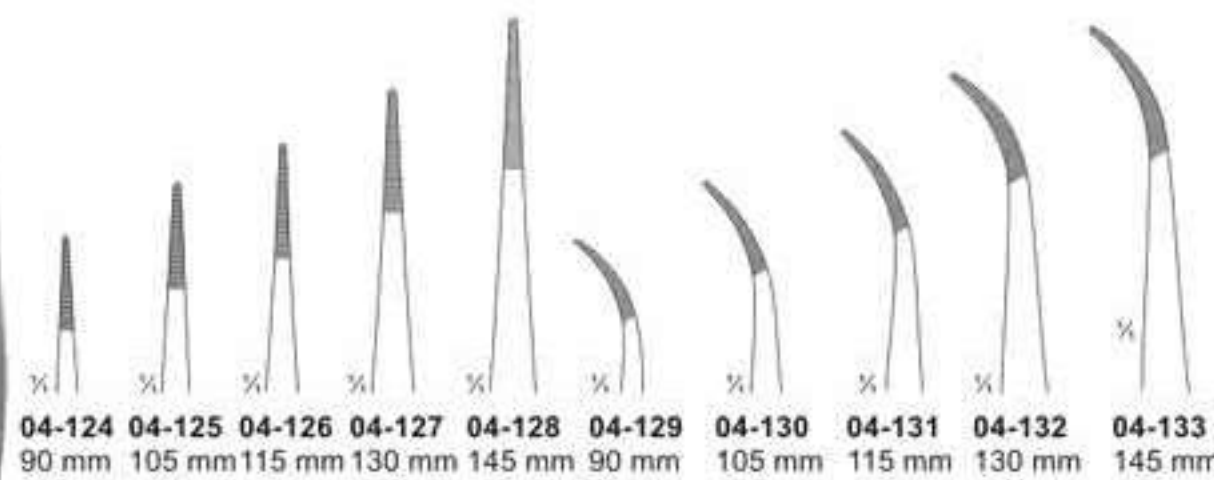

**04-124** 90 mm **04-125** 105 mm **04-126** 115 mm **04-127** 130 mm **04-128** 145 mm **04-129** 90 mm **04-130** 105 mm **04-131** 115 mm **04-132** 130 mm **04-133** 145 mm



**04-134**  
100 mm



**04-135**  
100 mm



**04-136**  
100 mm



**04-137**  
KUHNE  
Cover glass forceps, 105 mm



**04-138**  
160 mm

## Delicate Dissecting Forceps

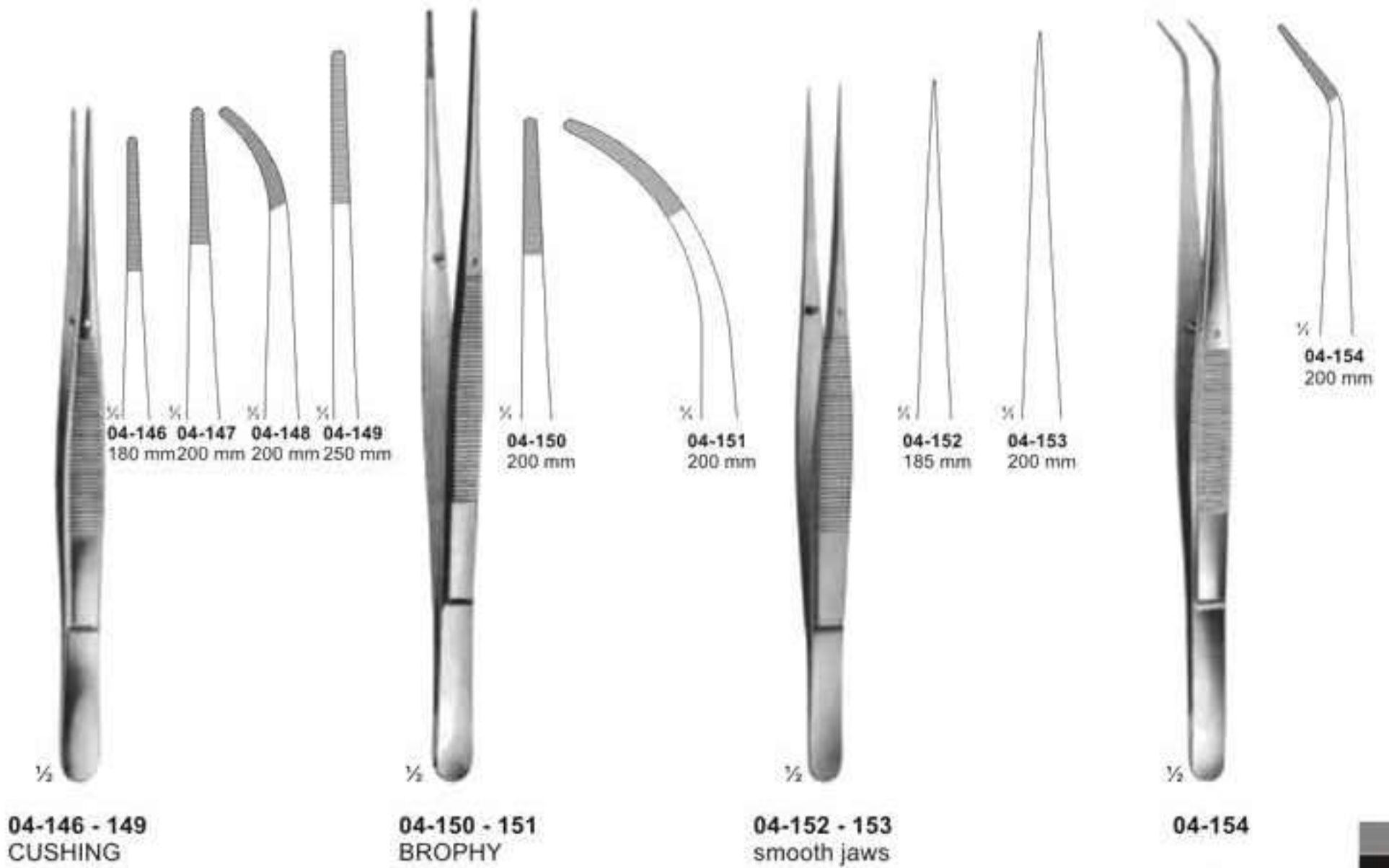
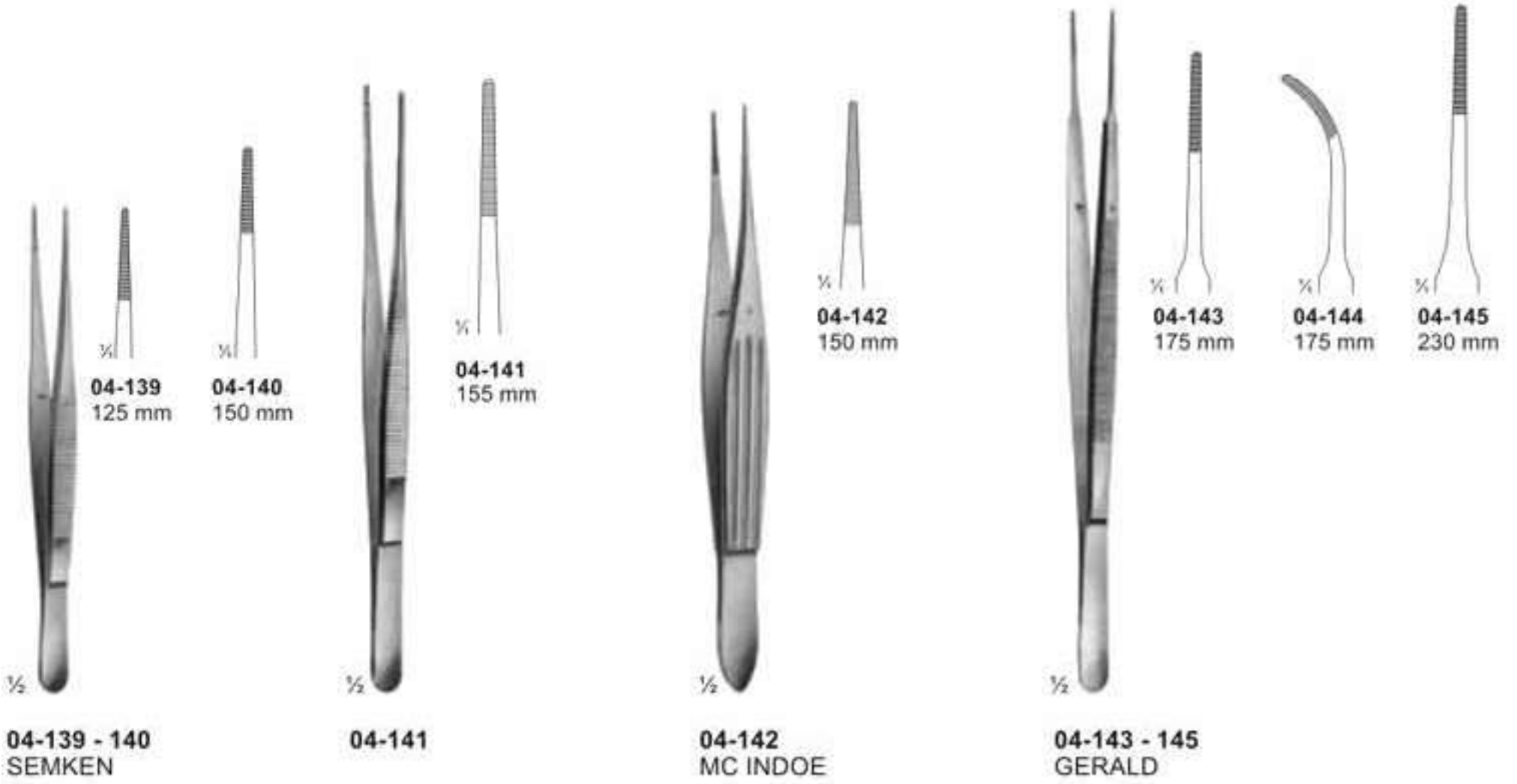

# Dissecting Forceps

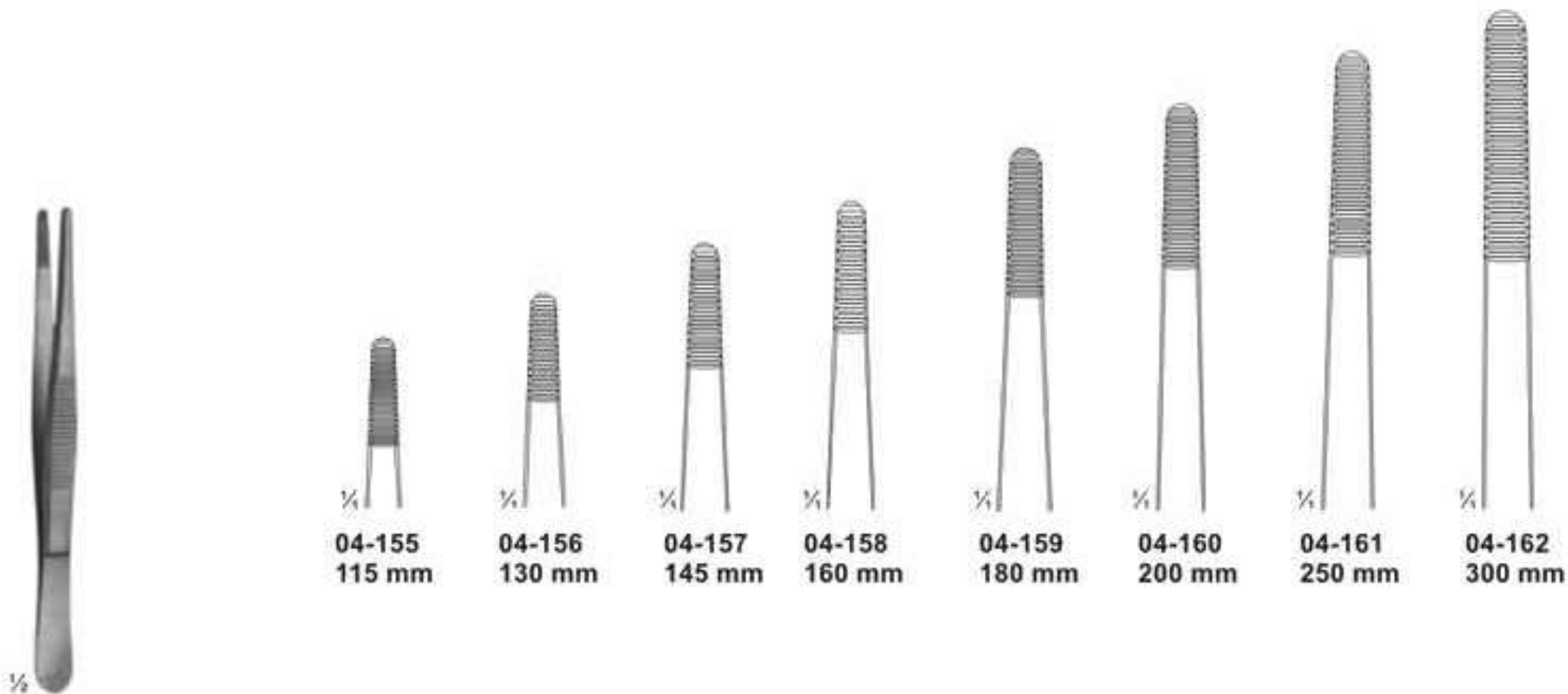

04-155 - 04-162  
STANDARD

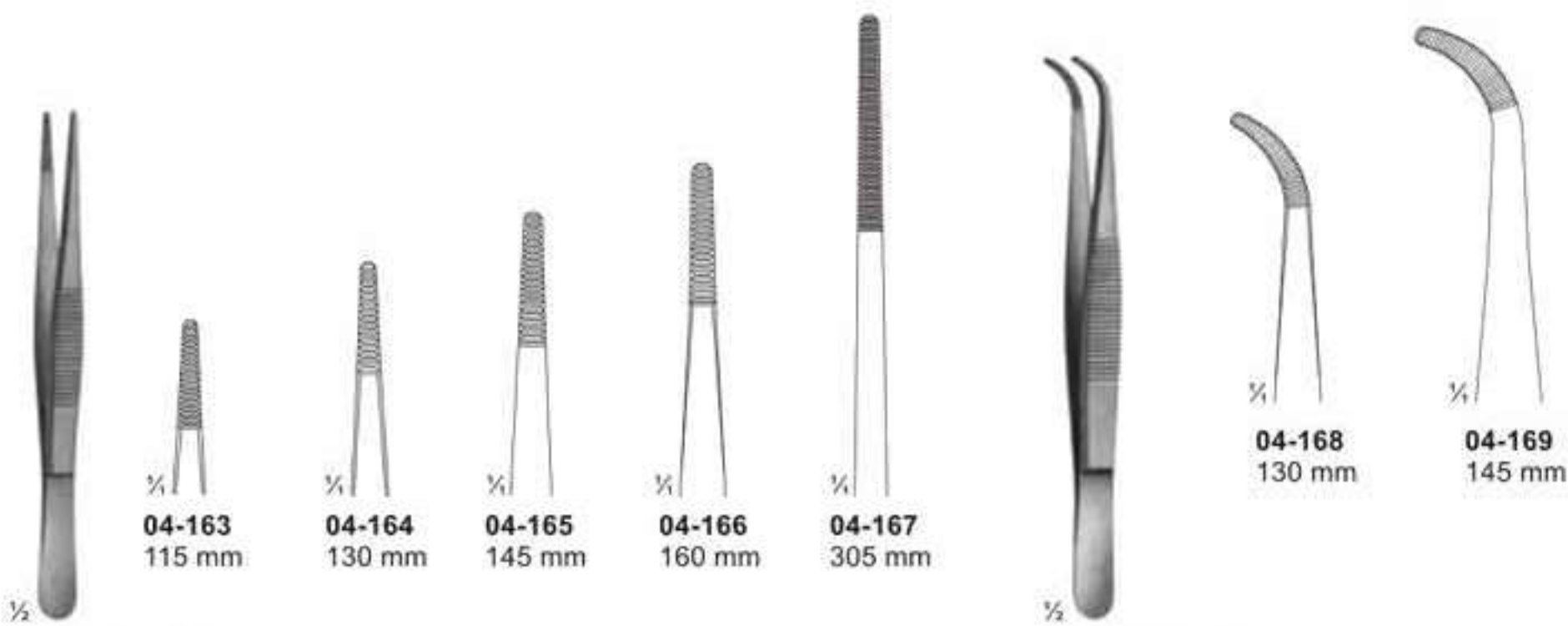

04-163 - 04-167  
MEDIUM

04-168 - 04-169  
MEDIUM

# Forceps

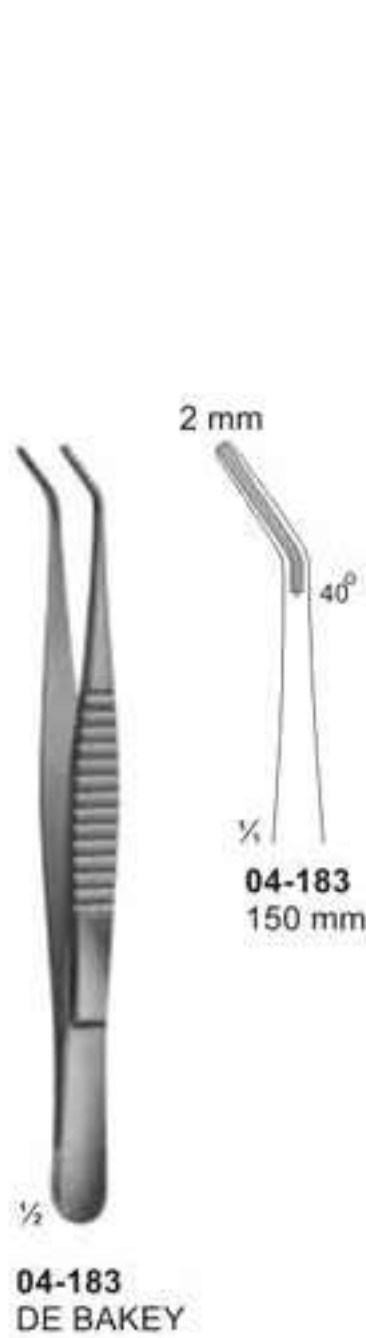
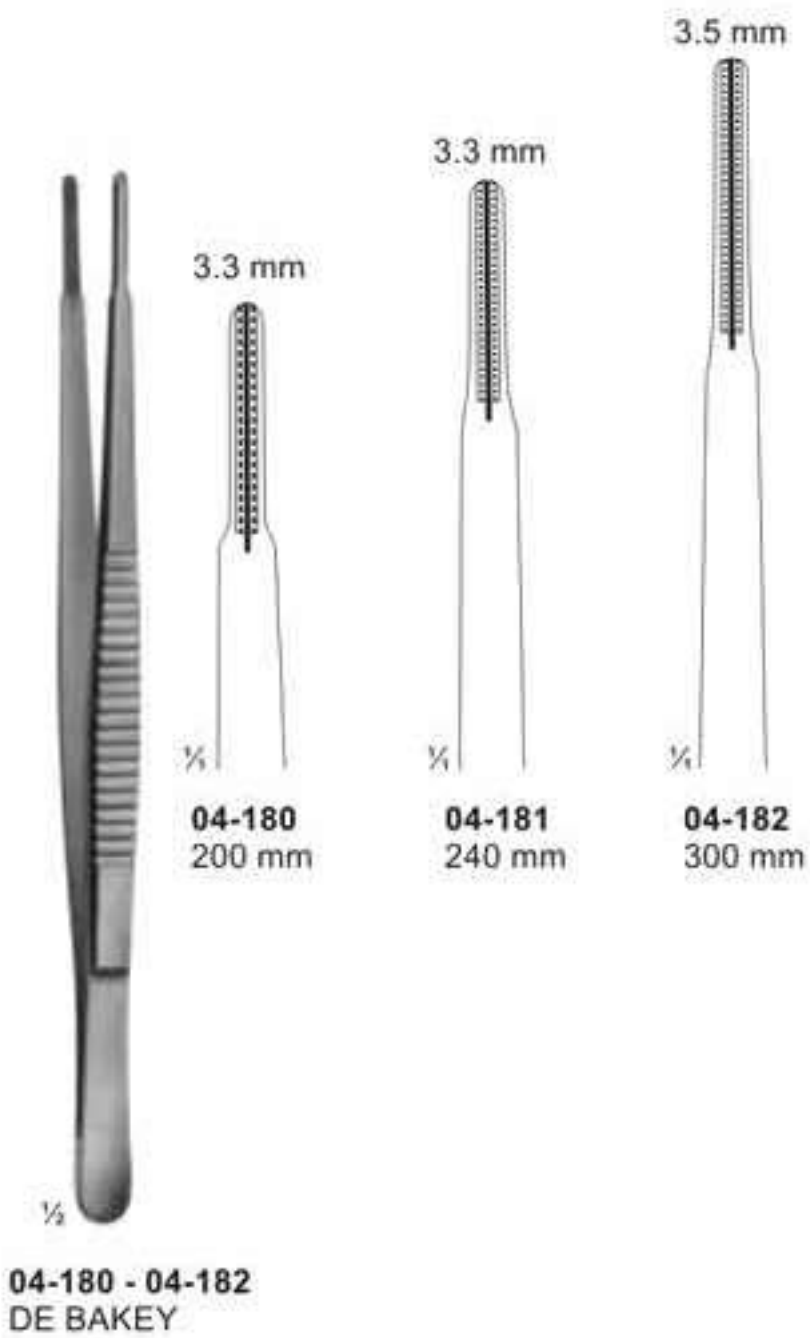
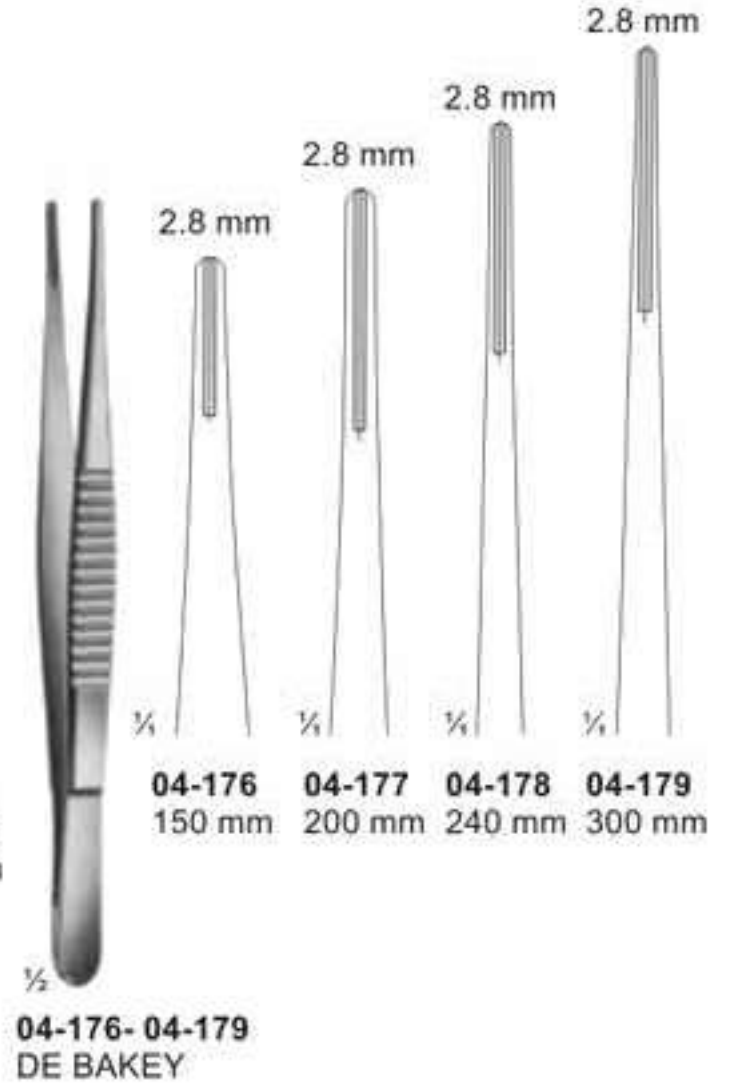
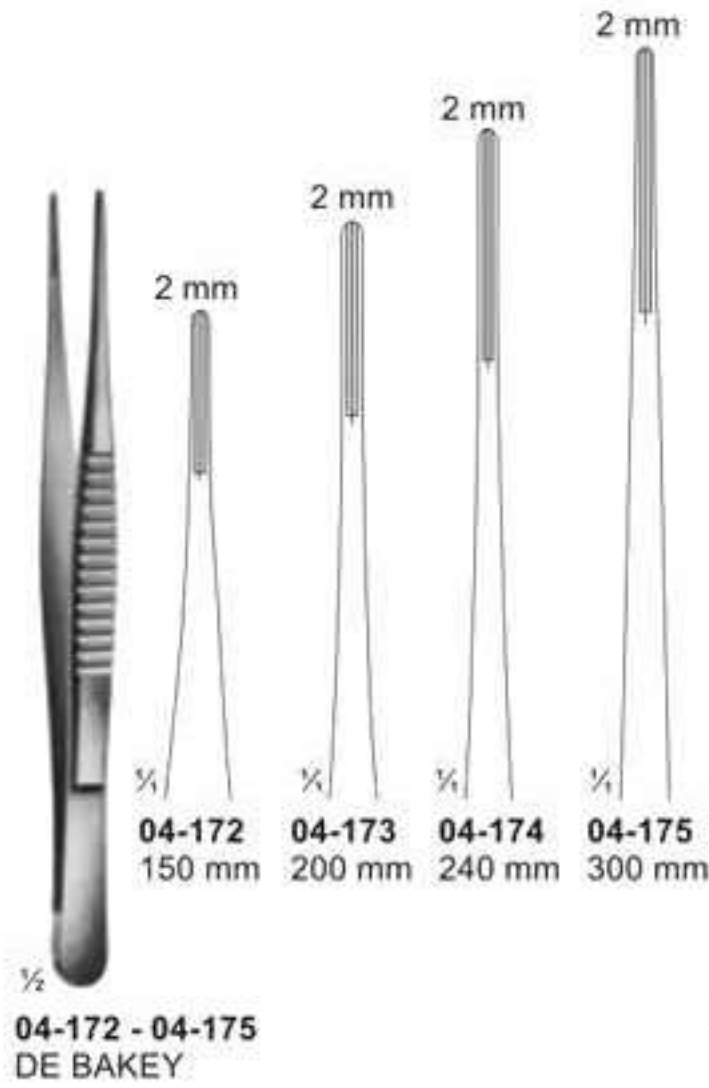
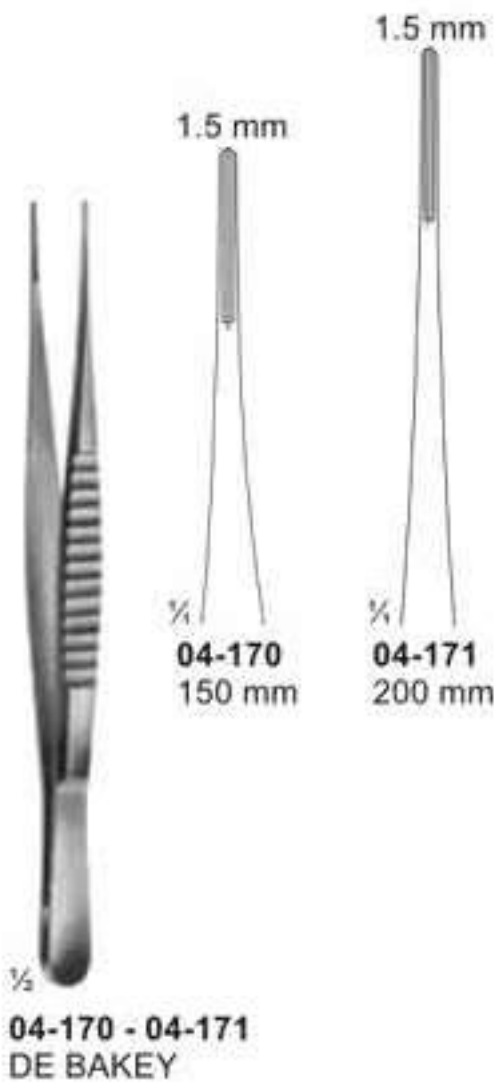

## Delicate Tissue Forceps

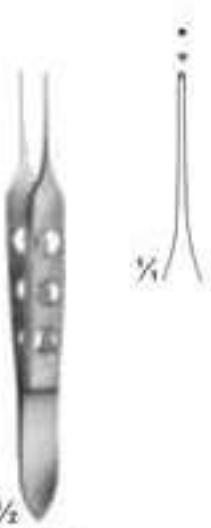

**04-185**  
BISHOP-HARMON  
85 mm

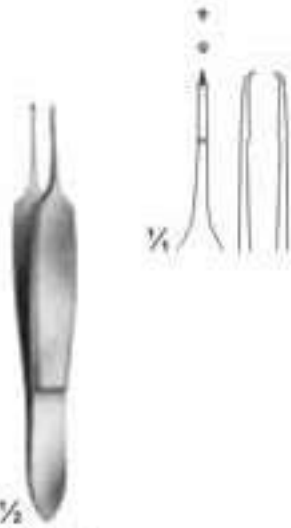

**04-186**  
ST. MARTIN  
80 mm

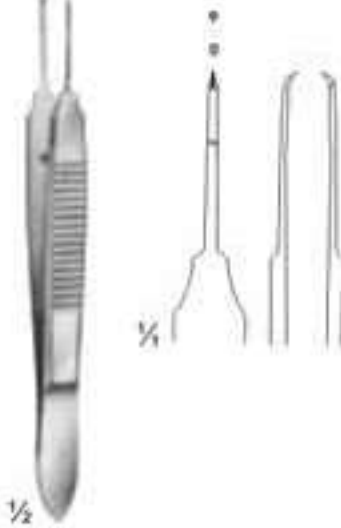

**04-187**  
CASTROVIEJO  
teeth 0.9 mm  
100 mm

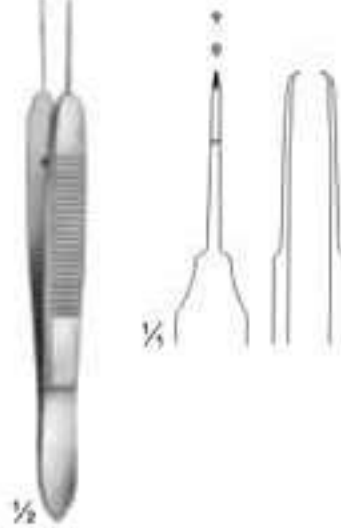

**04-188**  
CASTROVIEJO  
teeth 0.5 mm  
100 mm

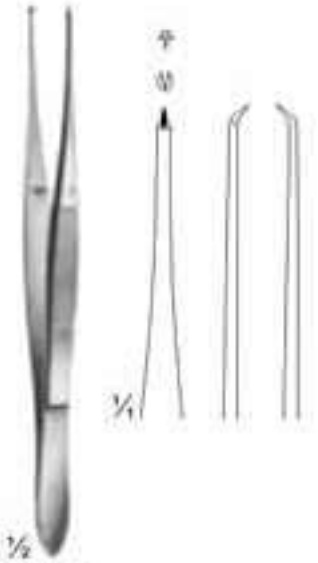

**04-189**  
ELSCHING  
110 mm



**04-190**  
GILL  
75 mm



**04-191**  
GILL - HESS  
75 mm

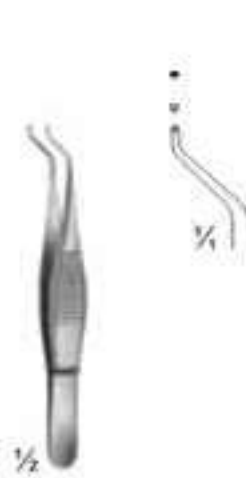

**04-192**  
HESS  
70 mm

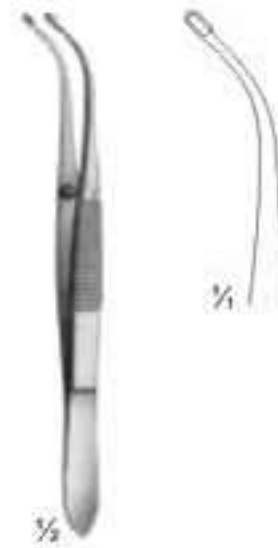

**04-193**  
ARRUGA  
100 mm



**04-194**  
SEMKEN  
125 mm 125 mm 150 mm  
2 X 3 teeth



**04-195**  
MICRO-ADSON  
120 mm

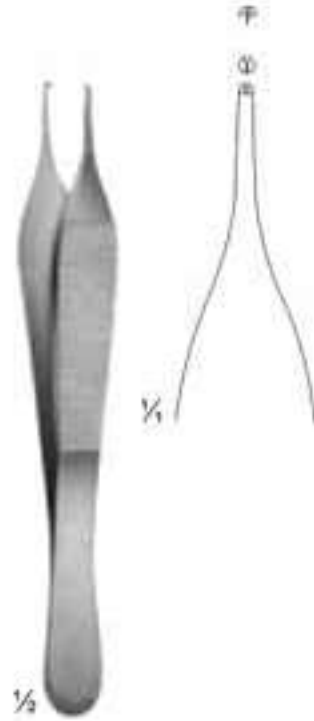

**04-196**  
ADSON  
120 mm



**04-197**  
ADSON  
120 mm



**04-198**  
ADSON  
120 mm

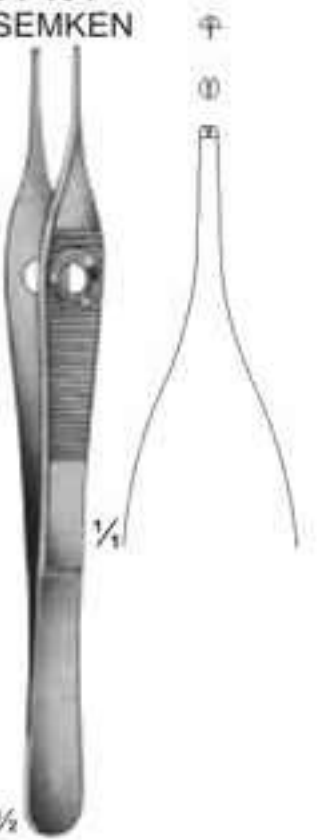

**04-199**  
ADSON  
150 mm



# Tissue Forceps

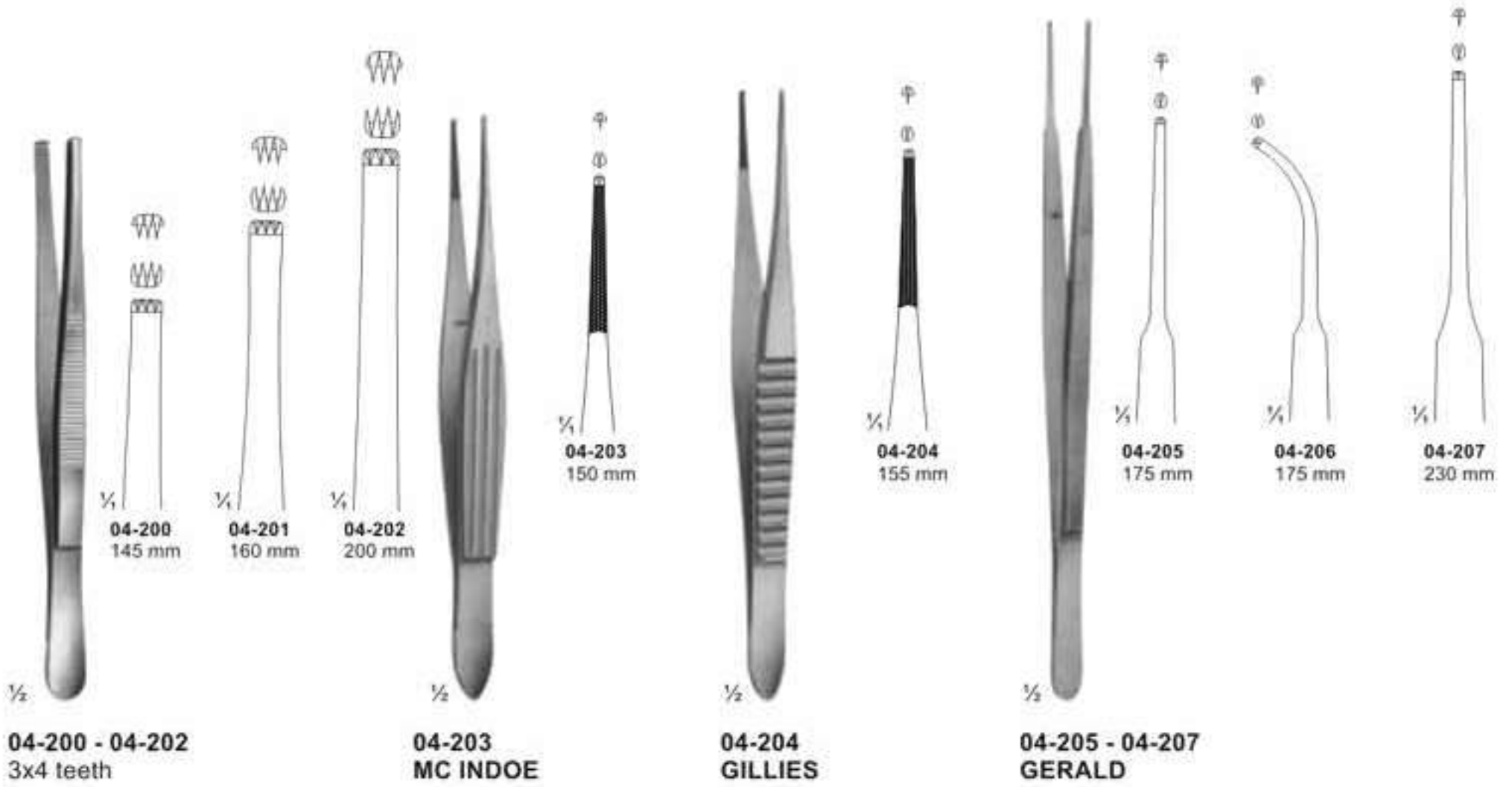

# Tissue Forceps

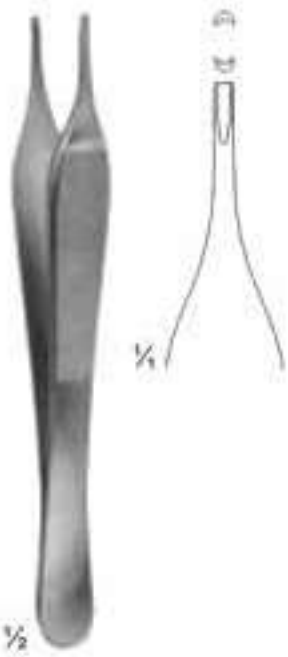

**04-213**  
**ADSON - BROWN**  
Non-traumatic  
120 mm

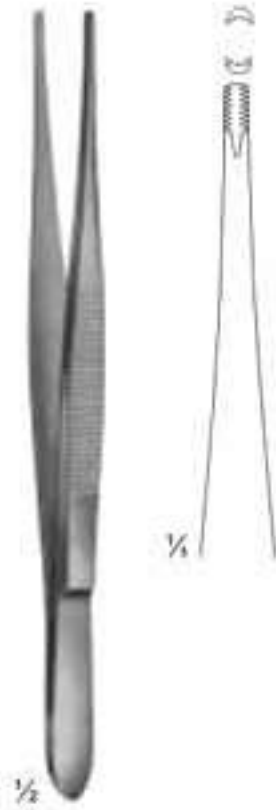

**04-214**  
**BROWN**  
120 mm

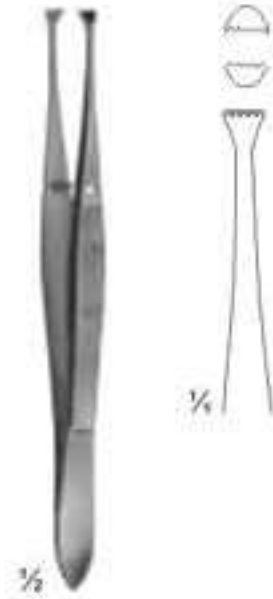

**04-215**  
**GRAEFE**  
110 mm



**04-216**  
**GRAEFE**  
With Catch  
110 mm

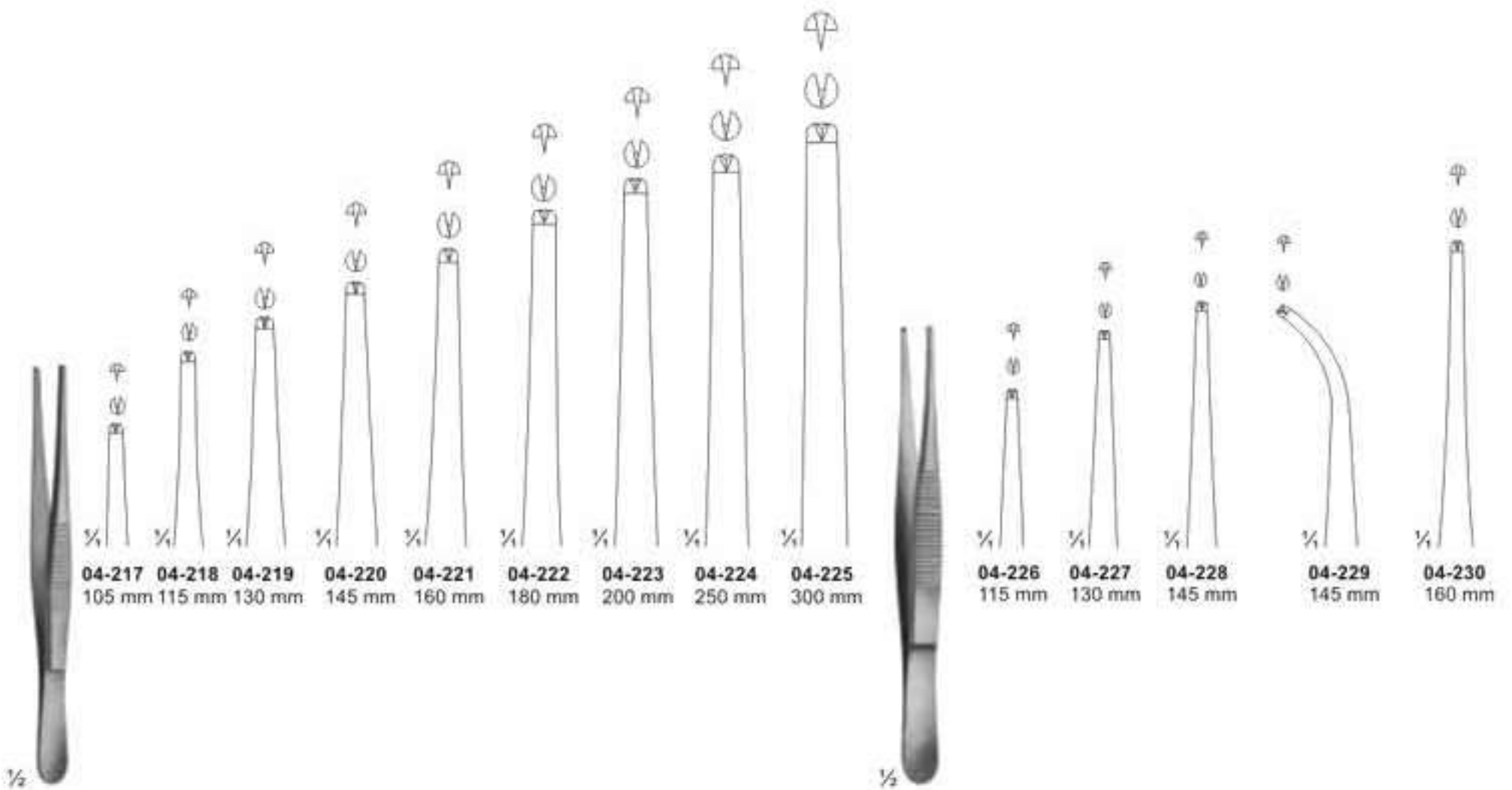

**04-217 - 04-225**  
**STANDARD**

**04-226 - 04-230**  
**GRAEFE**  
110 mm

## Forceps, Bayonet - Shaped

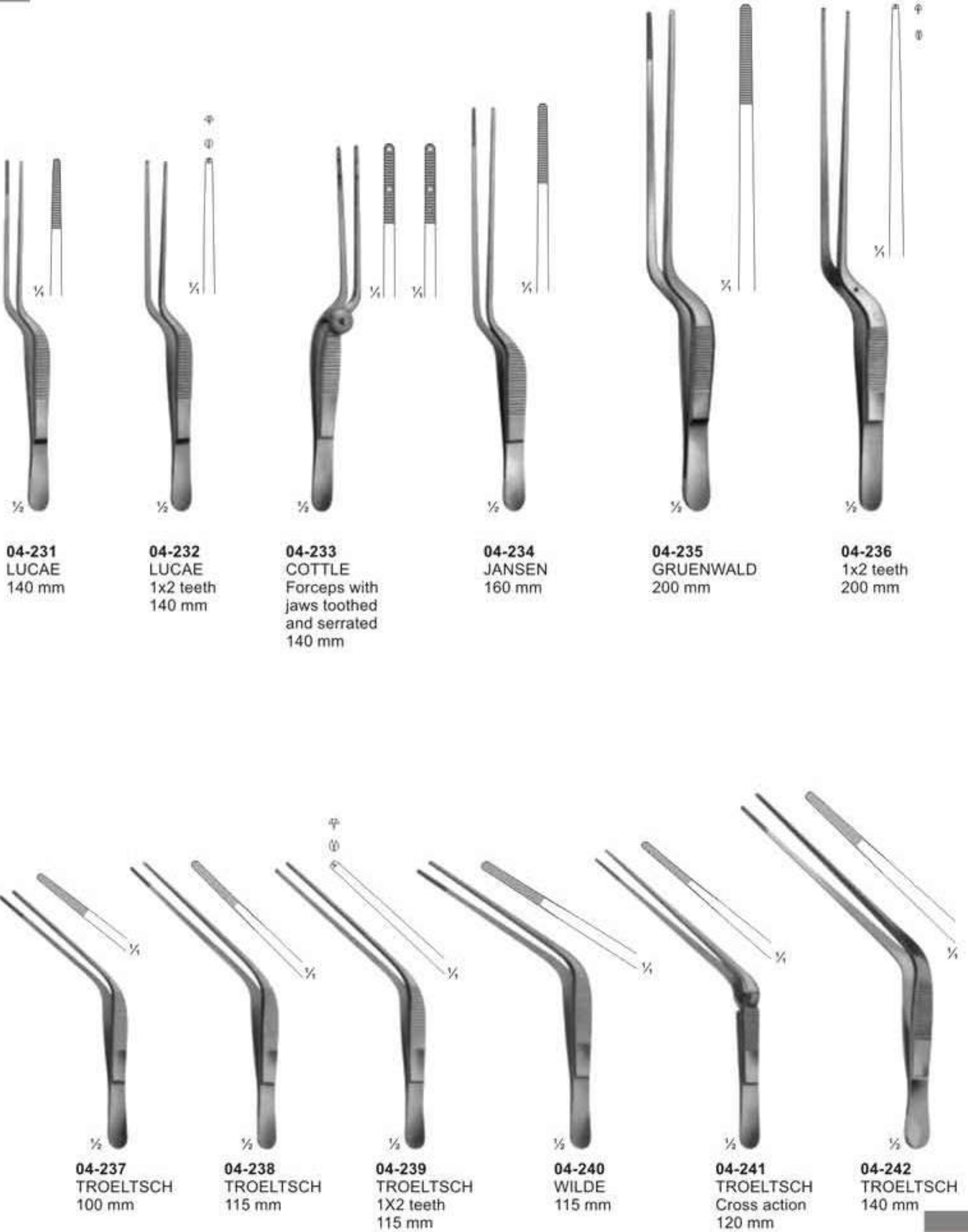

**04-231**  
LUCAE  
140 mm

**04-232**  
LUCAE  
1x2 teeth  
140 mm

**04-233**  
COTTLE  
Forceps with  
jaws toothed  
and serrated  
140 mm

**04-234**  
JANSEN  
160 mm

**04-235**  
GRUENWALD  
200 mm

**04-236**  
1x2 teeth  
200 mm

**04-237**  
TROELTSCH  
100 mm

**04-238**  
TROELTSCH  
115 mm

**04-239**  
TROELTSCH  
1X2 teeth  
115 mm

**04-240**  
WILDE  
115 mm

**04-241**  
TROELTSCH  
Cross action  
120 mm

**04-242**  
TROELTSCH  
140 mm

# Tissue Forceps, Lung Dissecting Forceps

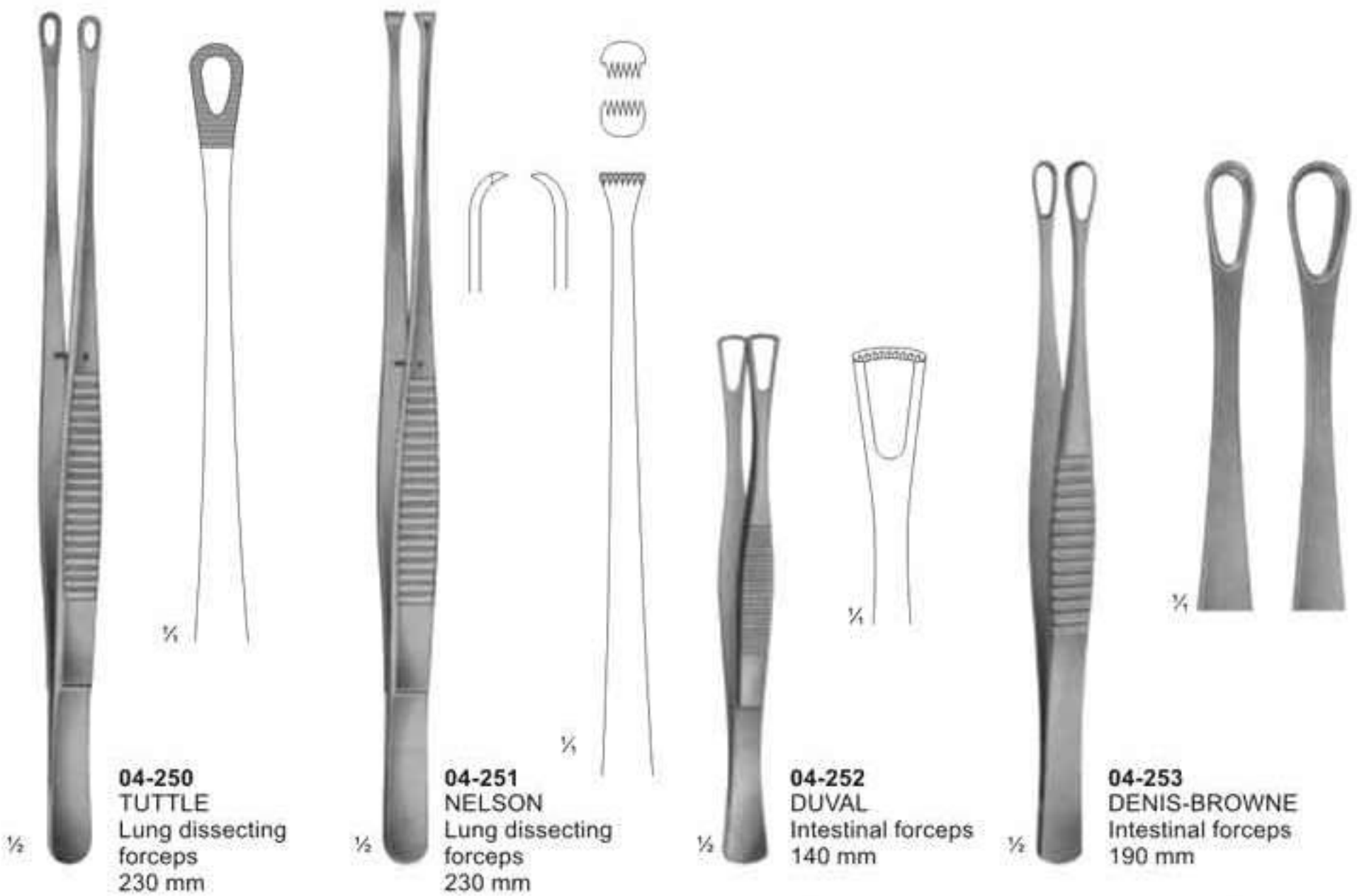
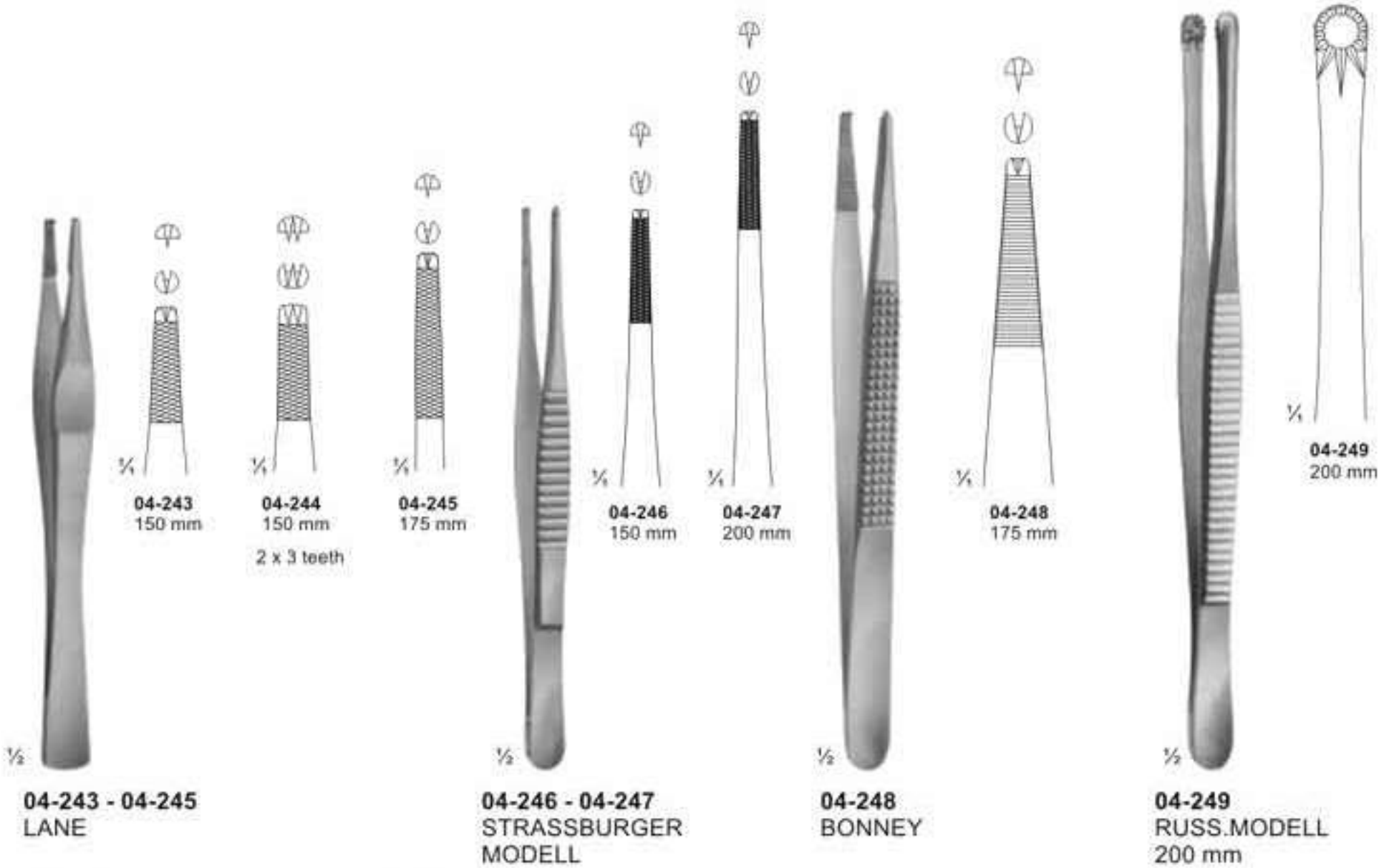

## Splinter and Cilia Forceps

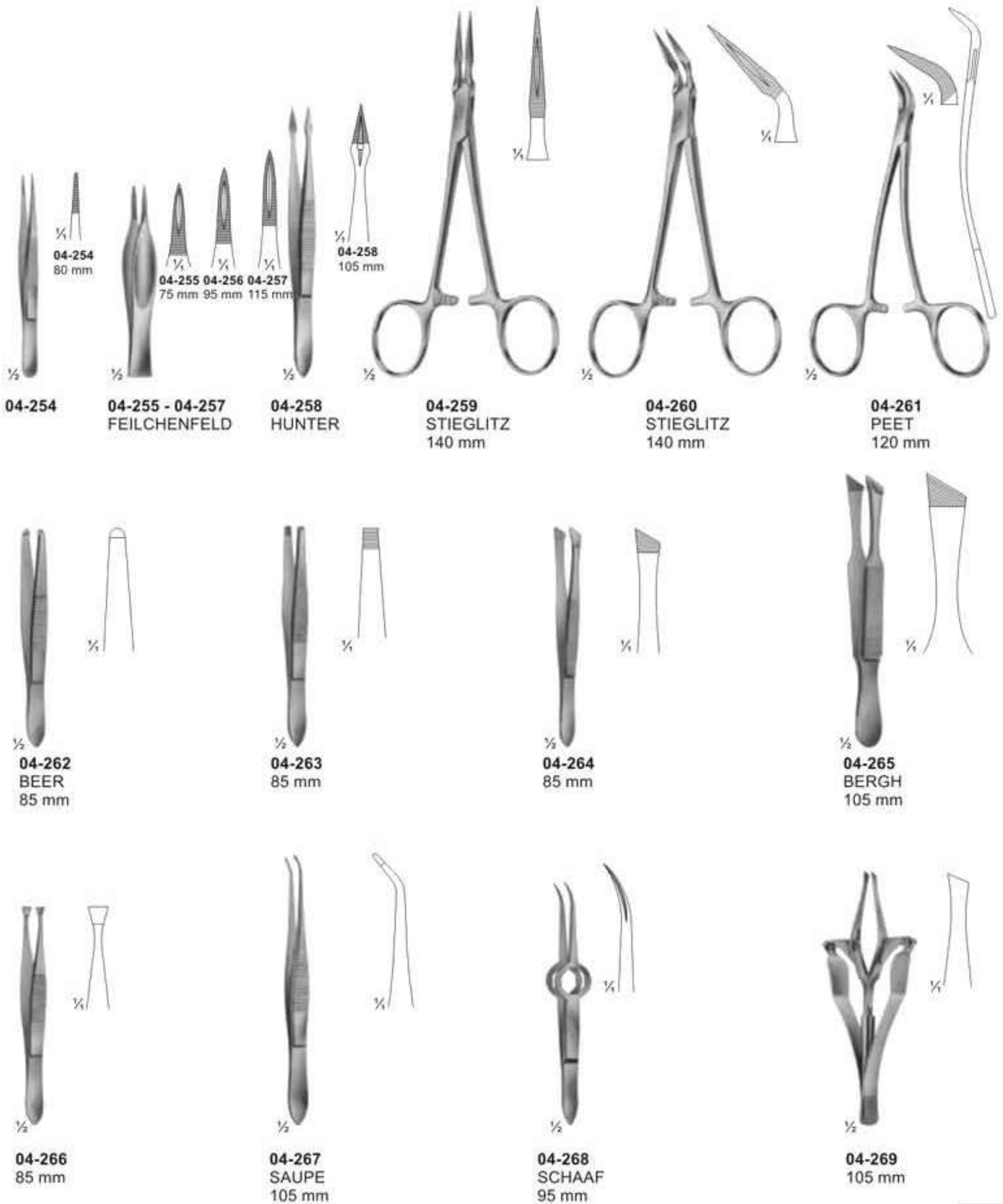

# Sponge and Dressing Forceps



**04-270**  
BRYANT  
130 mm

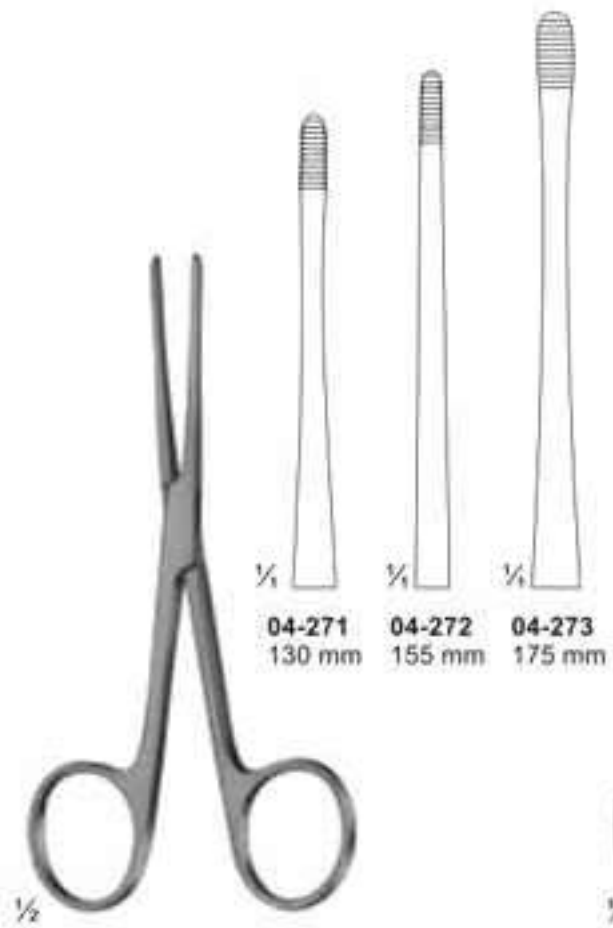

**04-271 - 04-273**  
LISTER  
Sinus forceps

04-271 130 mm  
04-272 155 mm  
04-273 175 mm

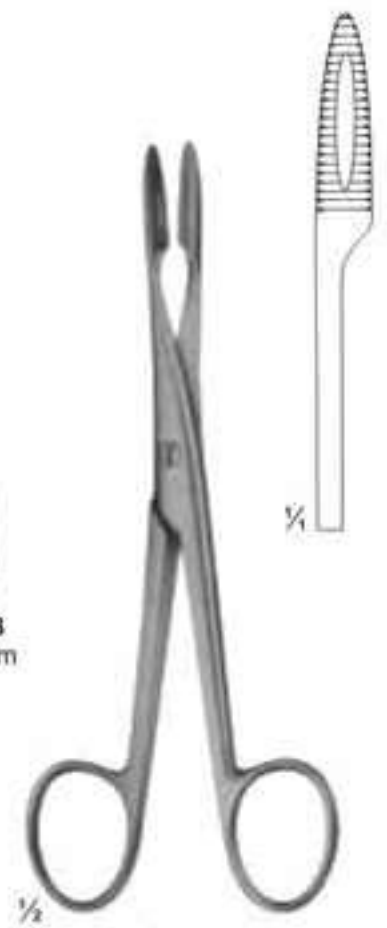

**04-274**  
without ratchet  
145 mm

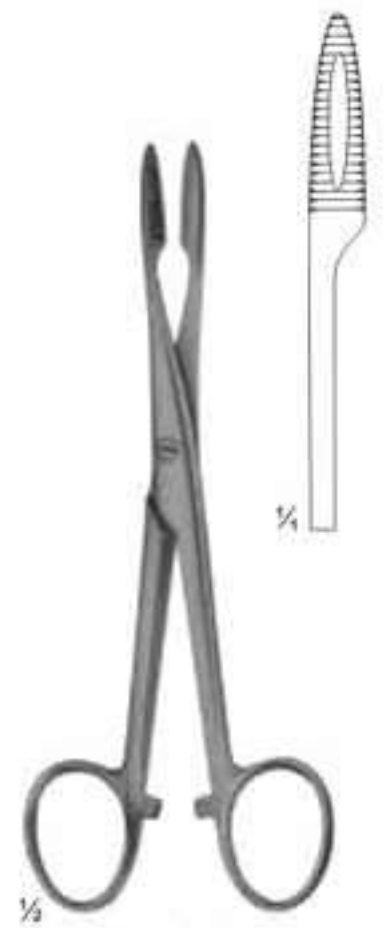

**04-275**  
with ratchet  
145 mm

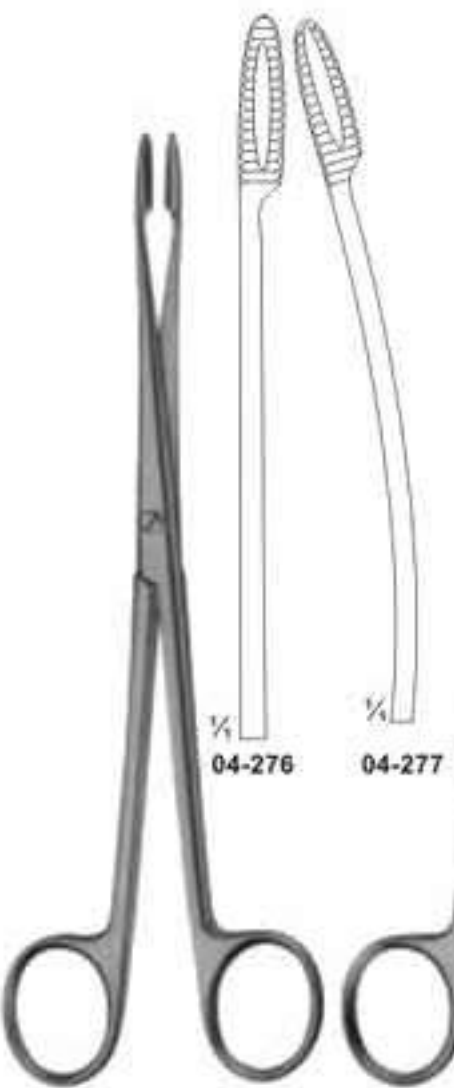

**04-276 - 04-277**  
GROSS  
without ratchet  
180 mm

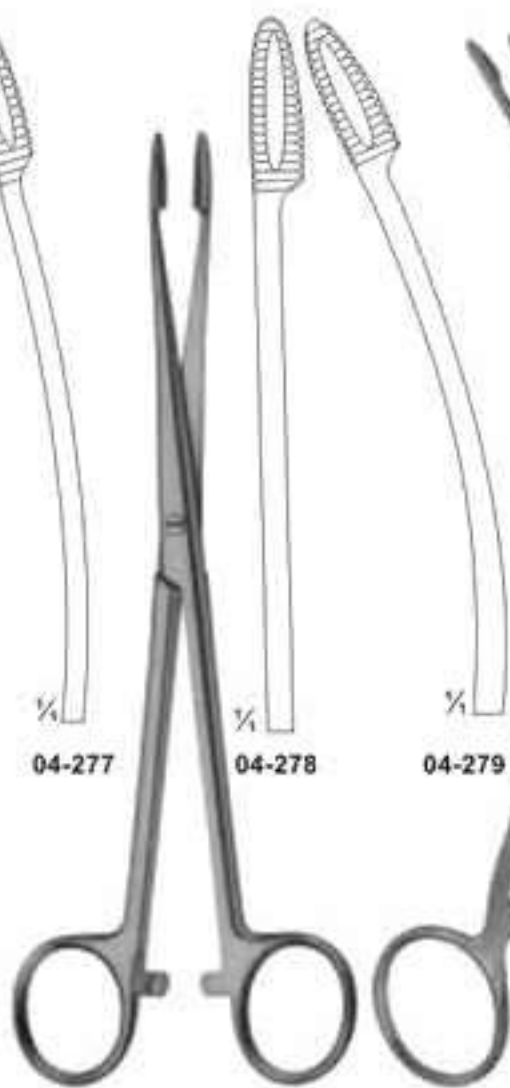

**04-278 - 04-279**  
GROSS  
with ratchet  
180 mm

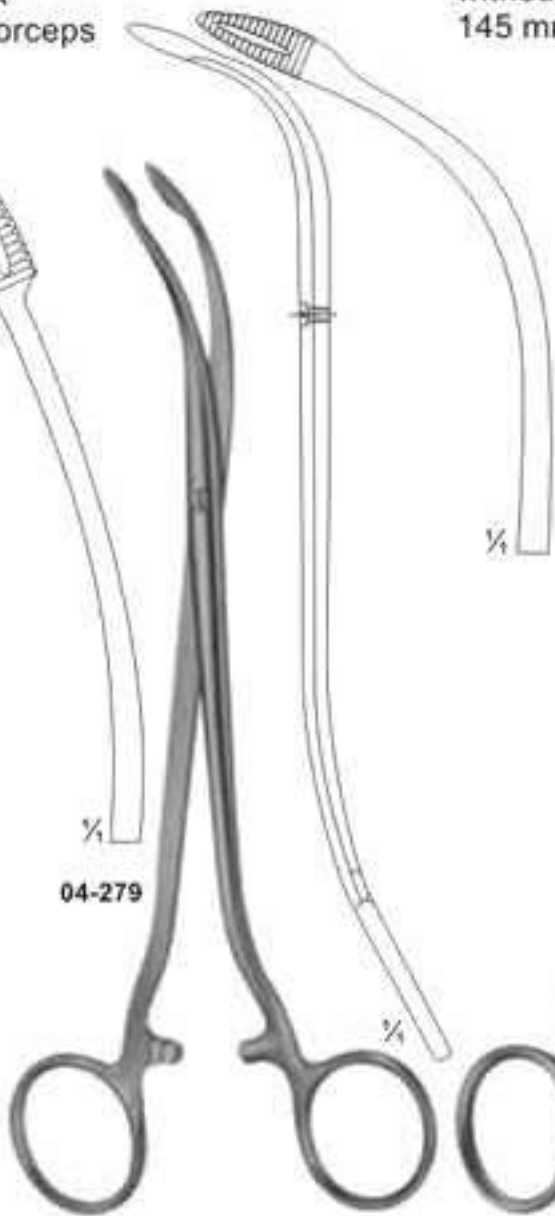

**04-280**  
DUPLAY  
190 mm

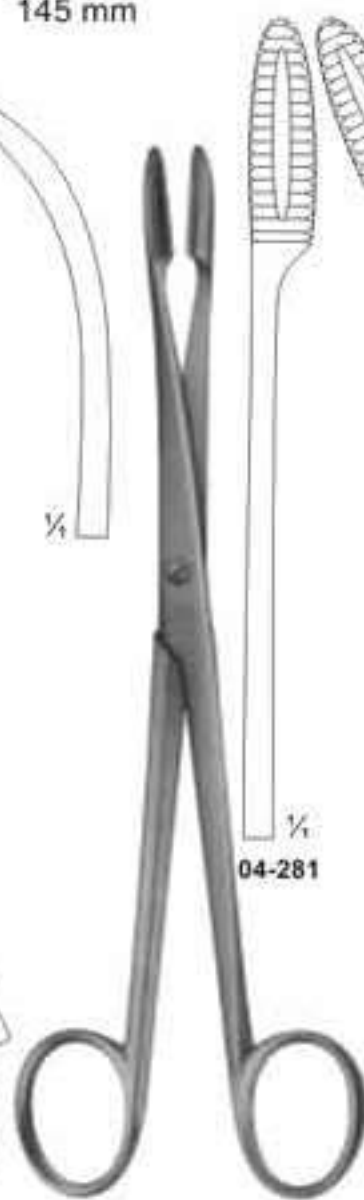

**04-281 - 04-282**  
GROSS  
without ratchet  
200 mm

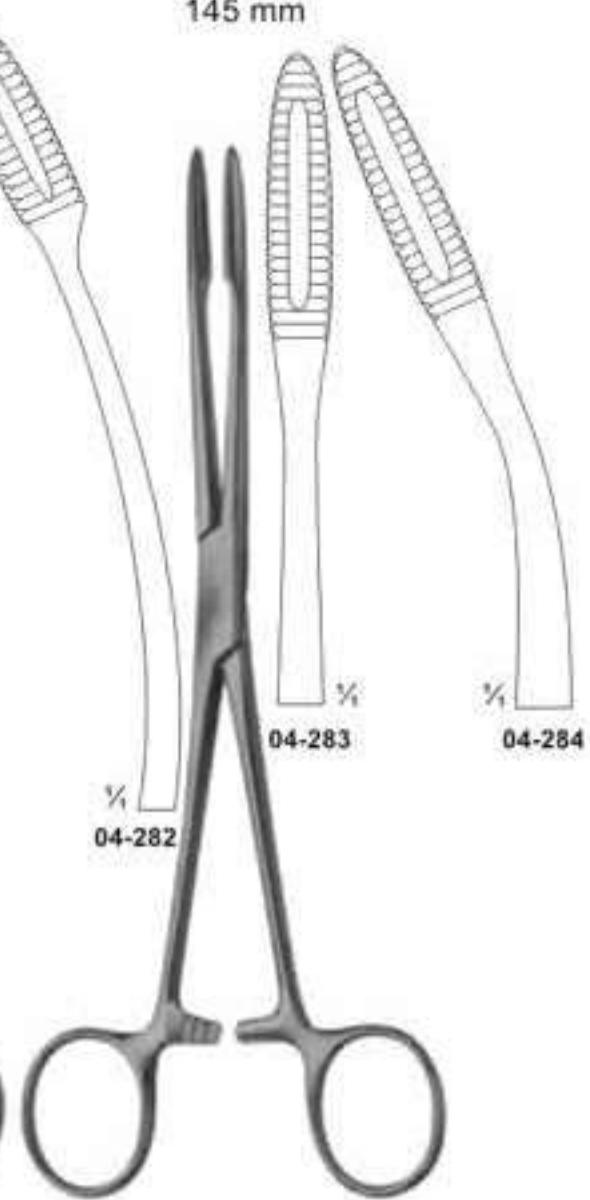

**04-283 - 04-284**  
GROSS  
200 mm

Dressing-, Sponge holding-, Organ- and Tissue Grasping Forceps

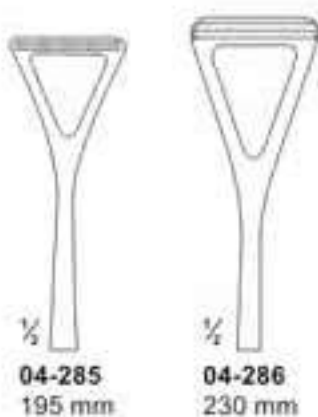

04-285 - 04-286  
COLLIN

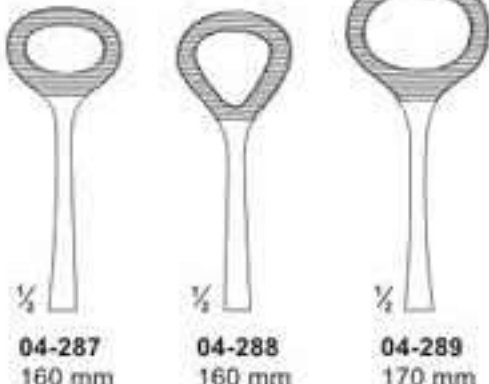
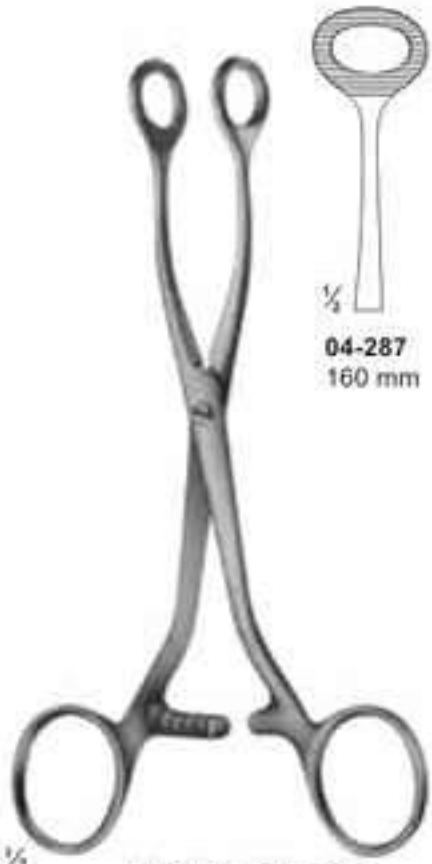

04-287 - 04-289  
COLLIN

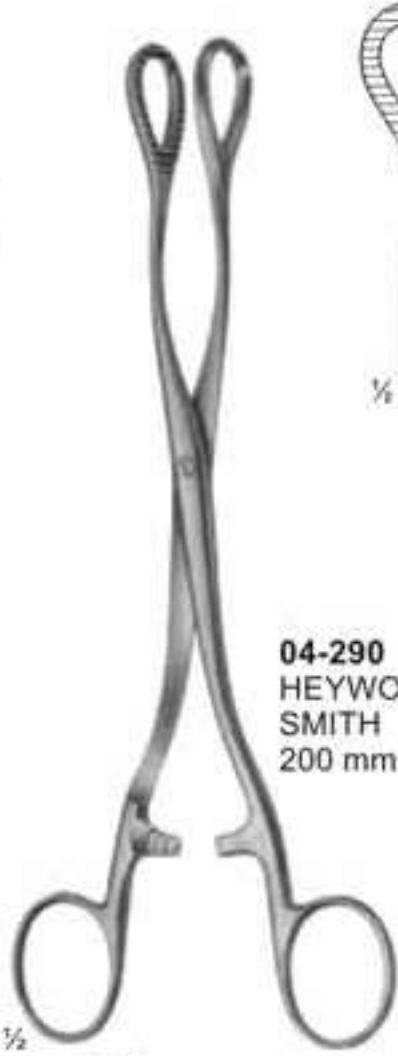

04-290  
HEYWOOD-  
SMITH  
200 mm

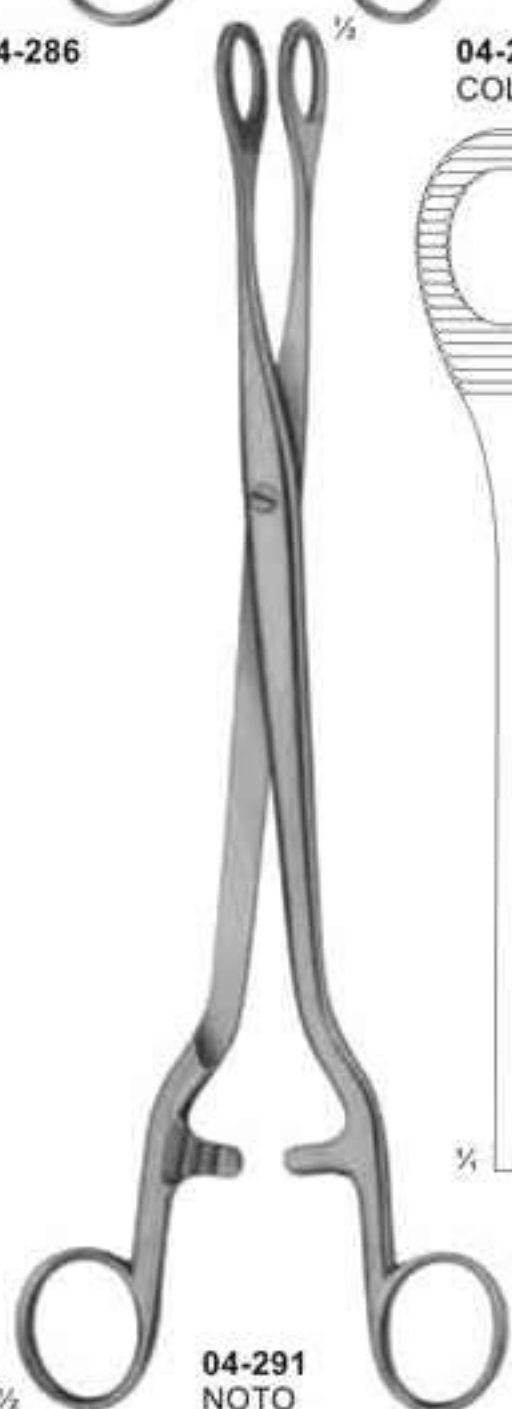

04-291  
NOTO  
280 mm



04-292  
KELLY  
320 mm

Dressing, Sponge holding, Organ  
and Tissue Grasping Forceps



04-293 - 04-294  
FOERSTER-BALLENGER  
180 mm



04-295 - 04-296  
RAMPLEY

04-296  
250 mm

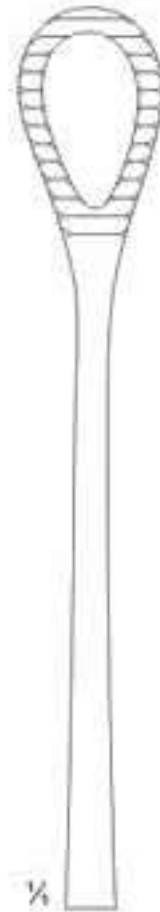

04-297  
Smooth Jaws

04-298  
Smooth Jaws

04-299  
Serrated Jaws

04-300  
Serrated Jaws

04-297 - 04-300  
FOERSTER-BALLENGER  
240 mm

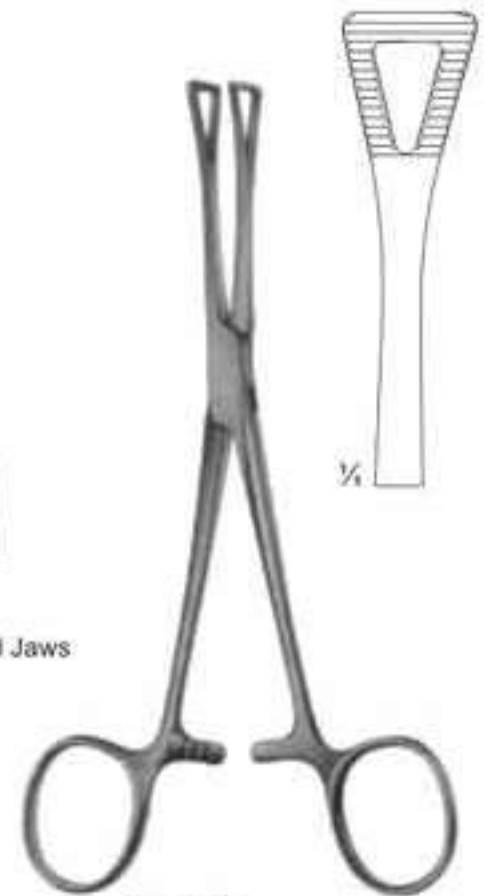

04-301  
PENNINGTON  
155 mm



# Intestinal Grasping Forceps

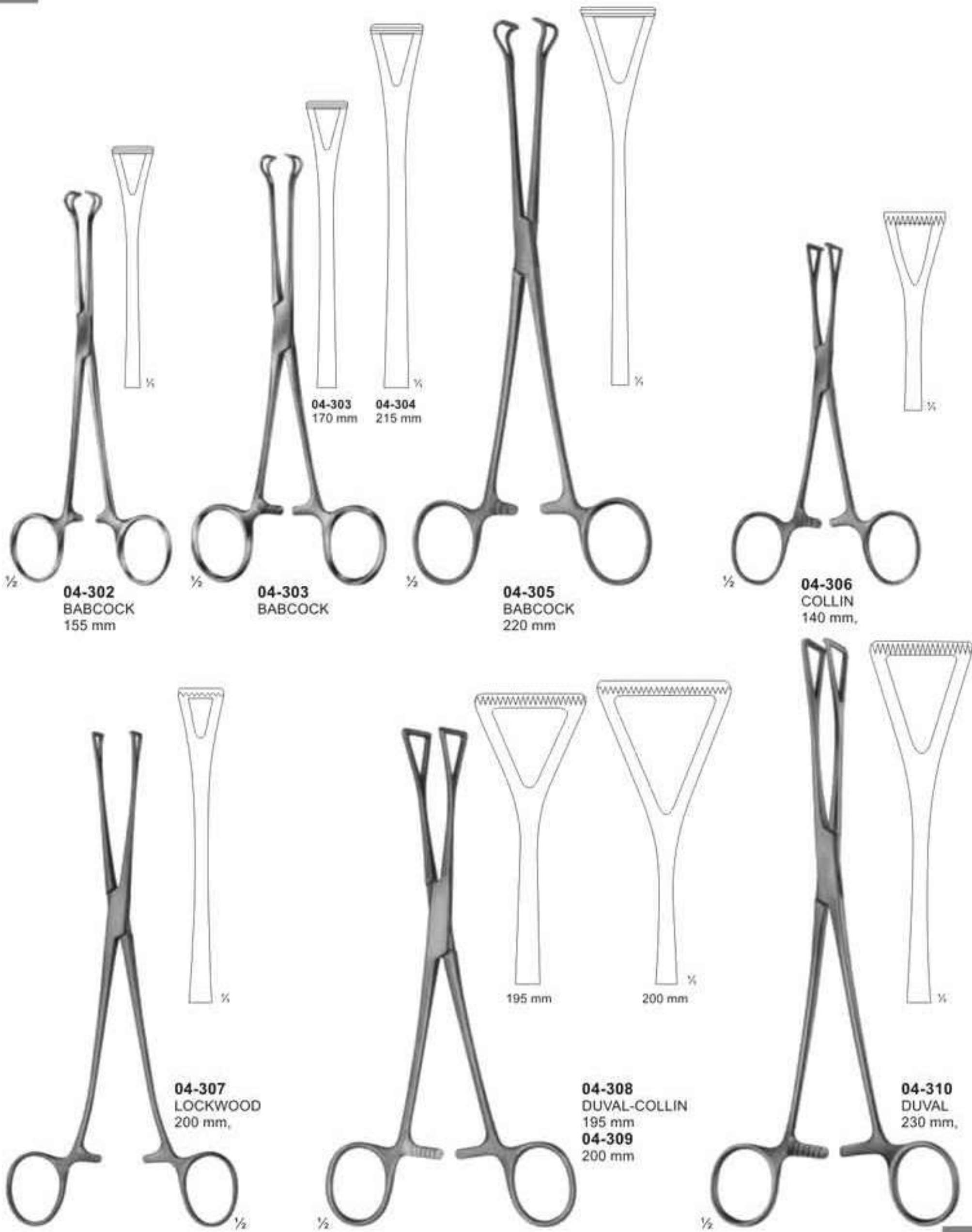

## Artery Traction - and Tissue Grasping Forceps



**04-311**  
CHAPUT  
2 x 3 teeth  
125 mm

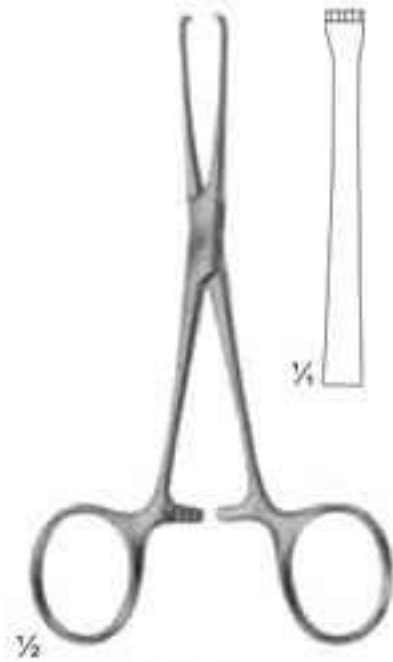

**04-312**  
BABY-ALLIS  
4 x 5 teeth  
130 mm



**04-313**  
BOYS-ALLIS  
5 x 6 teeth sharp  
155 mm

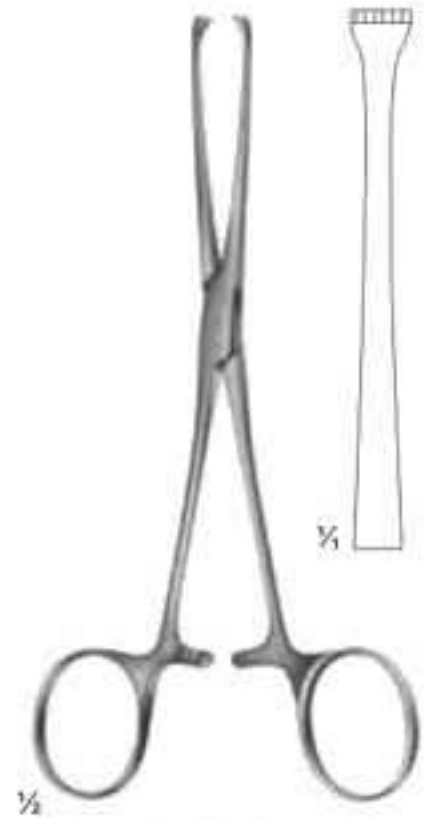

**04-314**  
ALLIS  
5 x 6 teeth  
155 mm



**04-315**  
LAHEY  
155 mm

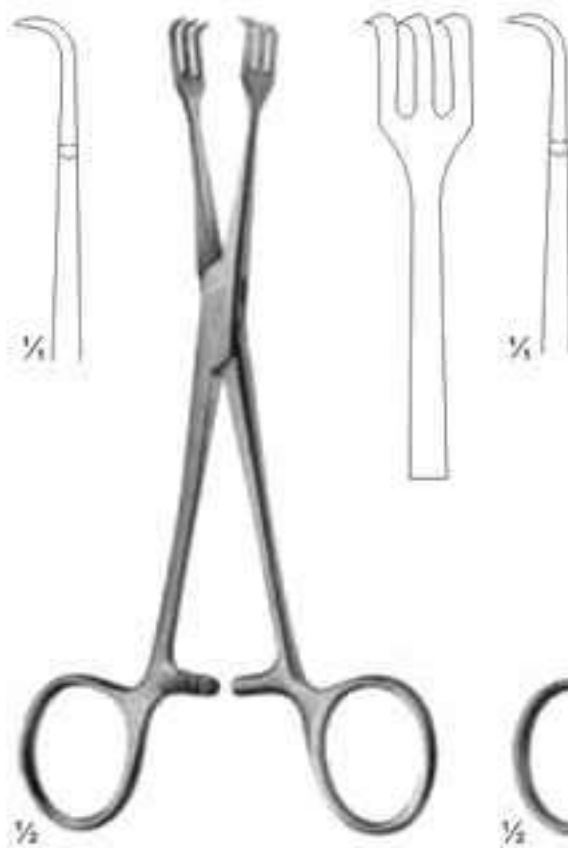

**04-316**  
LAHEY  
155 mm

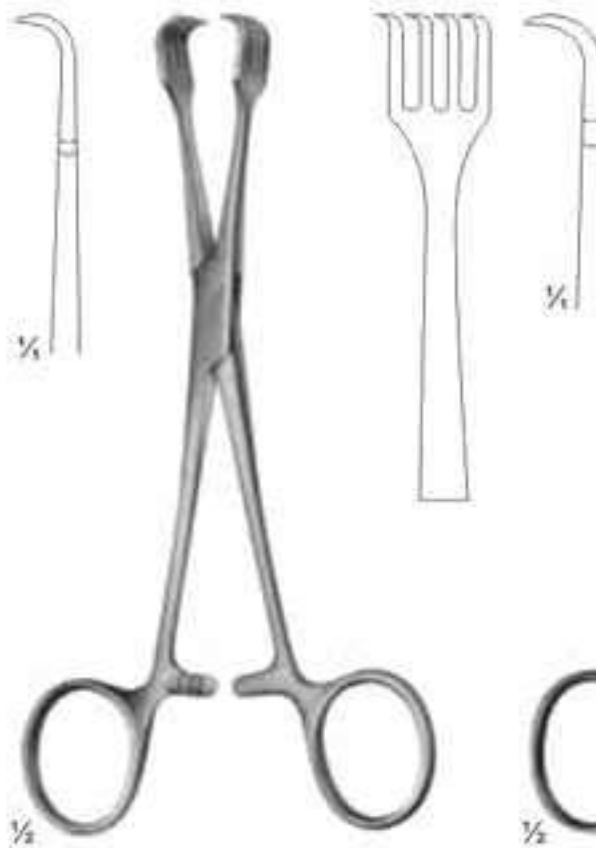

**04-317**  
BRAUN  
155 mm

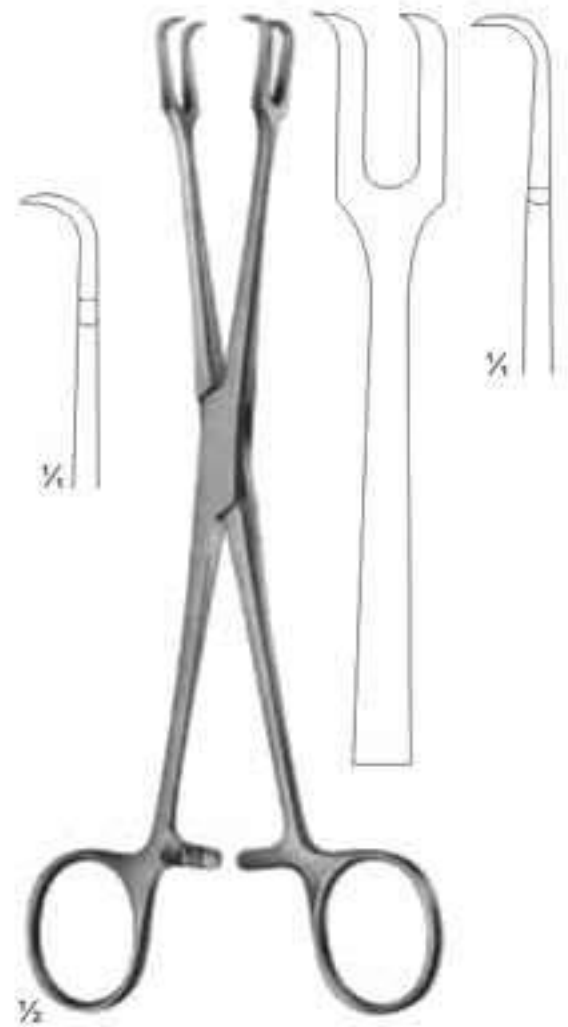

**04-318**  
MUSEUX  
200 mm

# Towel Clamps

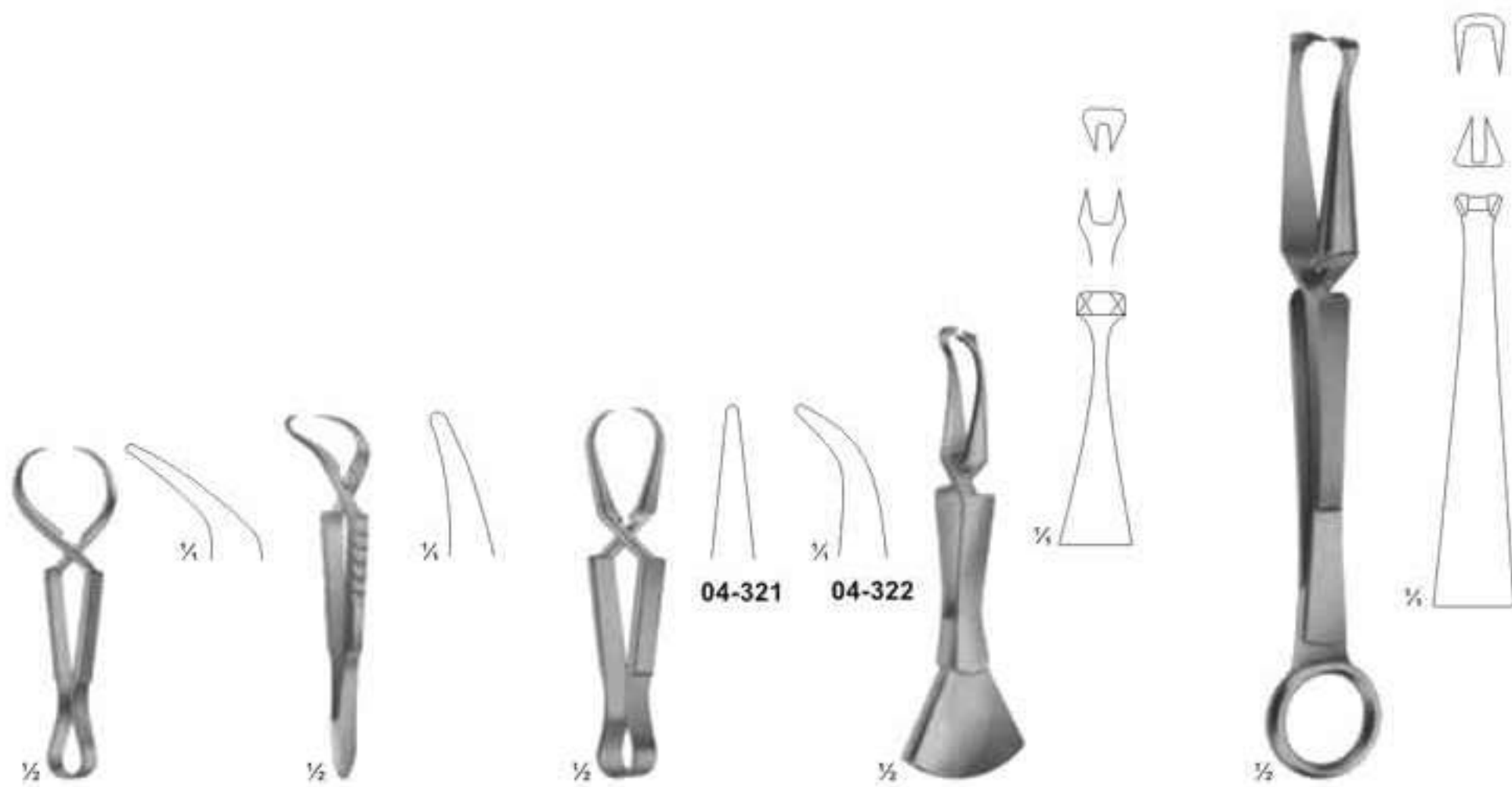

**04-319**  
JONES  
85 mm

**04-320**  
ENGL. MOD.  
85 mm

**04-321 - 04-322**  
SCHAEDEL  
85 mm

**04-323**  
DOYEN  
110 mm

**04-324**  
DOYEN  
180 mm

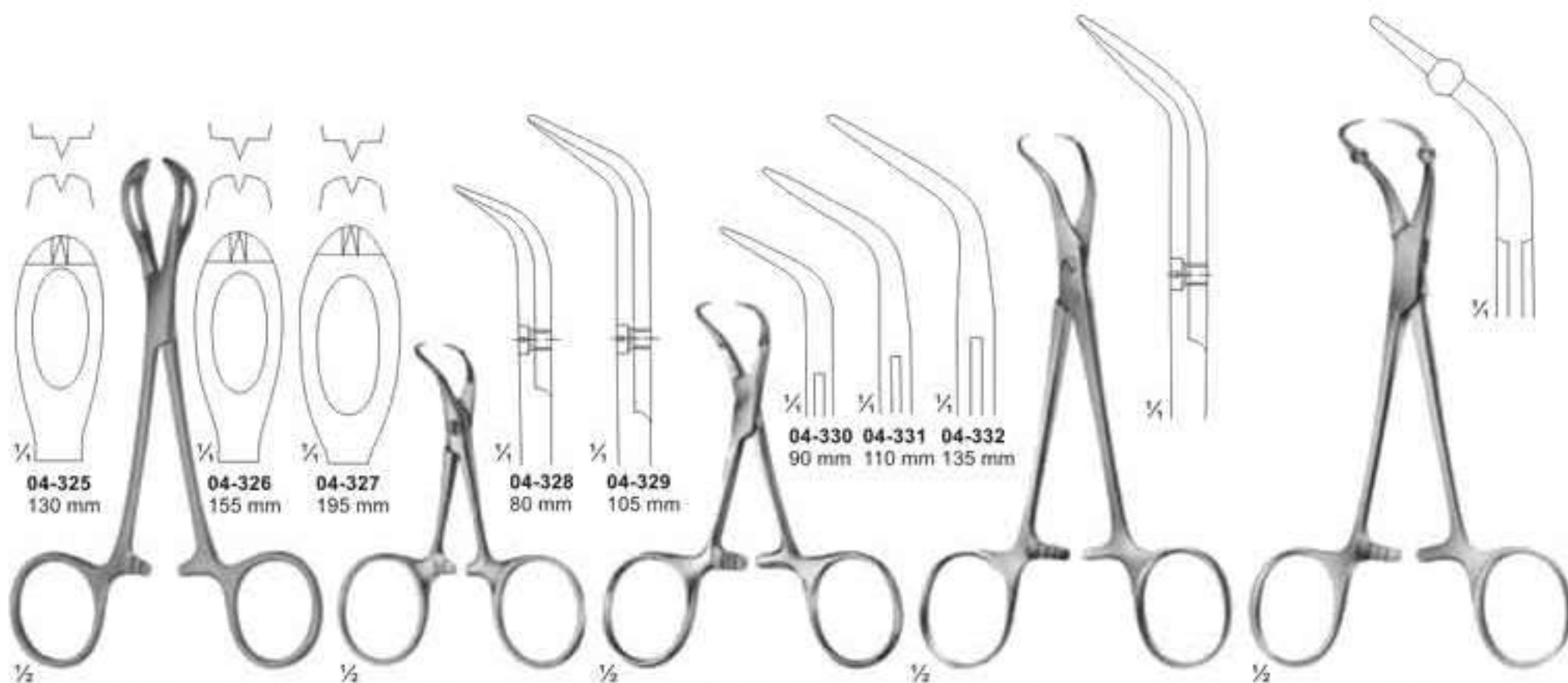

**04-325**  
130 mm

**04-326**  
155 mm

**04-327**  
195 mm

**04-328**  
80 mm

**04-329**  
105 mm

**04-330 04-331 04-332**  
90 mm 110 mm 135 mm

**04-333**  
135 mm

**04-334**  
135 mm

**04-325 - 04-327**  
LANE

**04-328 - 04-329**  
BACKHAUS























**04-330 - 04-332**  
BACKHAUS

**04-333**  
BACKHAUS-KOCHER  
135 mm

**04-334**  
ROEDER  
135 mm

## Muller Vessel Clips and Bulldog Clamps

### Closing force

						
04-335 straight	04-336 curved	04-337 curved tips	04-338 angled shaped	04-339 MULLER knee-bent	04-340 Muller Ligature Forceps	Jaw, cross serrated
80g 50g	80g 50g	80g 50g	80g 50g	80g 50g	80g 50g	
						
04-341 35 mm	04-342 35 mm	04-343 45 mm	04-344 45 mm	DIEFFENBACH 04-345 38 mm	DIEFFENBACH 04-346 48 mm	DIEFFENBACH 04-347 38 mm
				DIEFFENBACH 04-348 48 mm	DIEFFENBACH 04-349 58 mm	DIEFFENBACH 04-350 58 mm
						JOHNS-HOPKINS 04-351 - 04-357 91 mm
						04-351 38 mm
						04-352 48 mm
						04-353 56 mm
						04-354 63 mm
						04-355 70 mm
						04-356 80 mm
						04-357 91 mm
						
04-358 DE BAKEY- HESS 20 mm						
						
DE BAKEY 04-359 length 50 mm jaws 27 mm	DE BAKEY 04-360 length 48 mm jaws 27 mm	GLOVER 04-361 length 57 mm jaws 35 mm	DE BAKEY 04-362 length 73 mm jaws 38 mm	DE BAKEY 04-363 length 99 mm jaws 63 mm	DE BAKEY 04-364 length 95 mm jaws 54 mm	DE BAKEY 04-365 L. 80 mm
						04-366 L. 90 mm
						04-367 L. 105 mm
						04-368 L. 124 mm
						DE BAKEY 04-369 L. 78 mm
						DE BAKEY 04-370 L. 86 mm
						04-371 L. 97 mm
						04-372 L. 114 mm
						GLOVER 04-373 L. 68 mm
						04-374 L. 96 mm
						04-375 L. 117 mm
						GLOVER 04-376 L. 65 mm
						04-377 L. 91 mm
						04-378 L. 110 mm

## Delicate Haemostatic Forceps

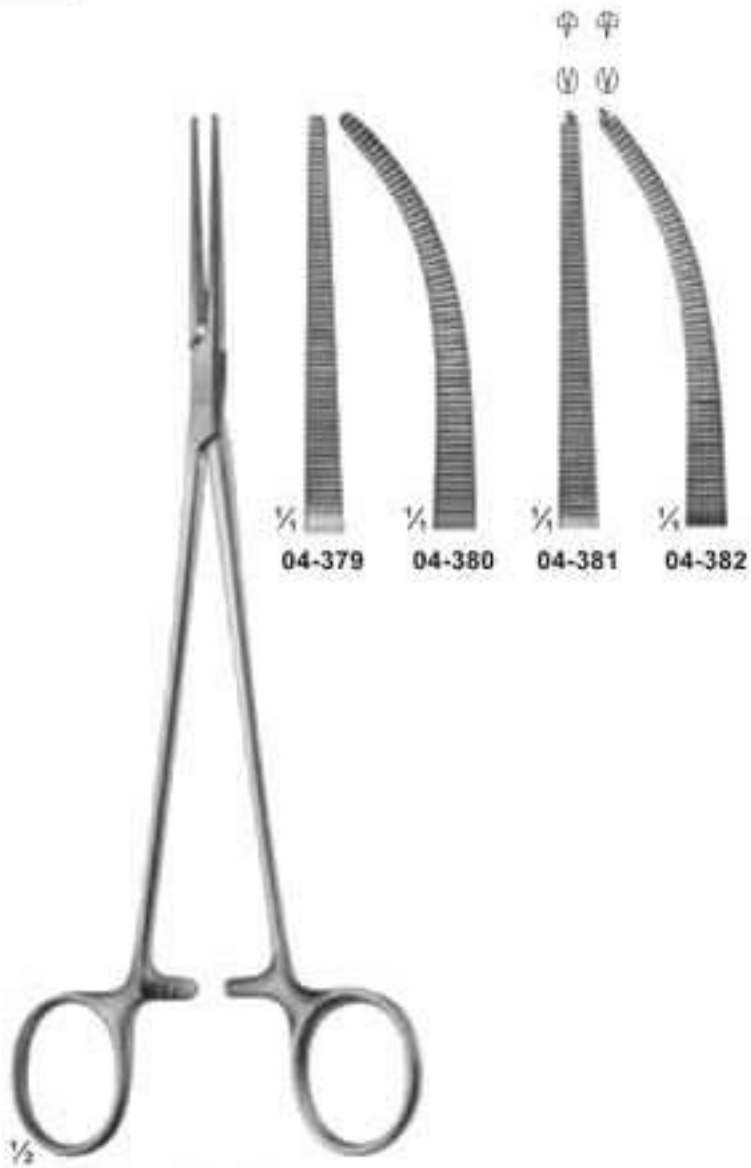

04-379 - 04-382  
HALSTED-MOSQUITO  
200 mm



04-383 - 04-387  
HEISS  
200 mm



04-388 - 04-389  
HALSTED  
215 mm

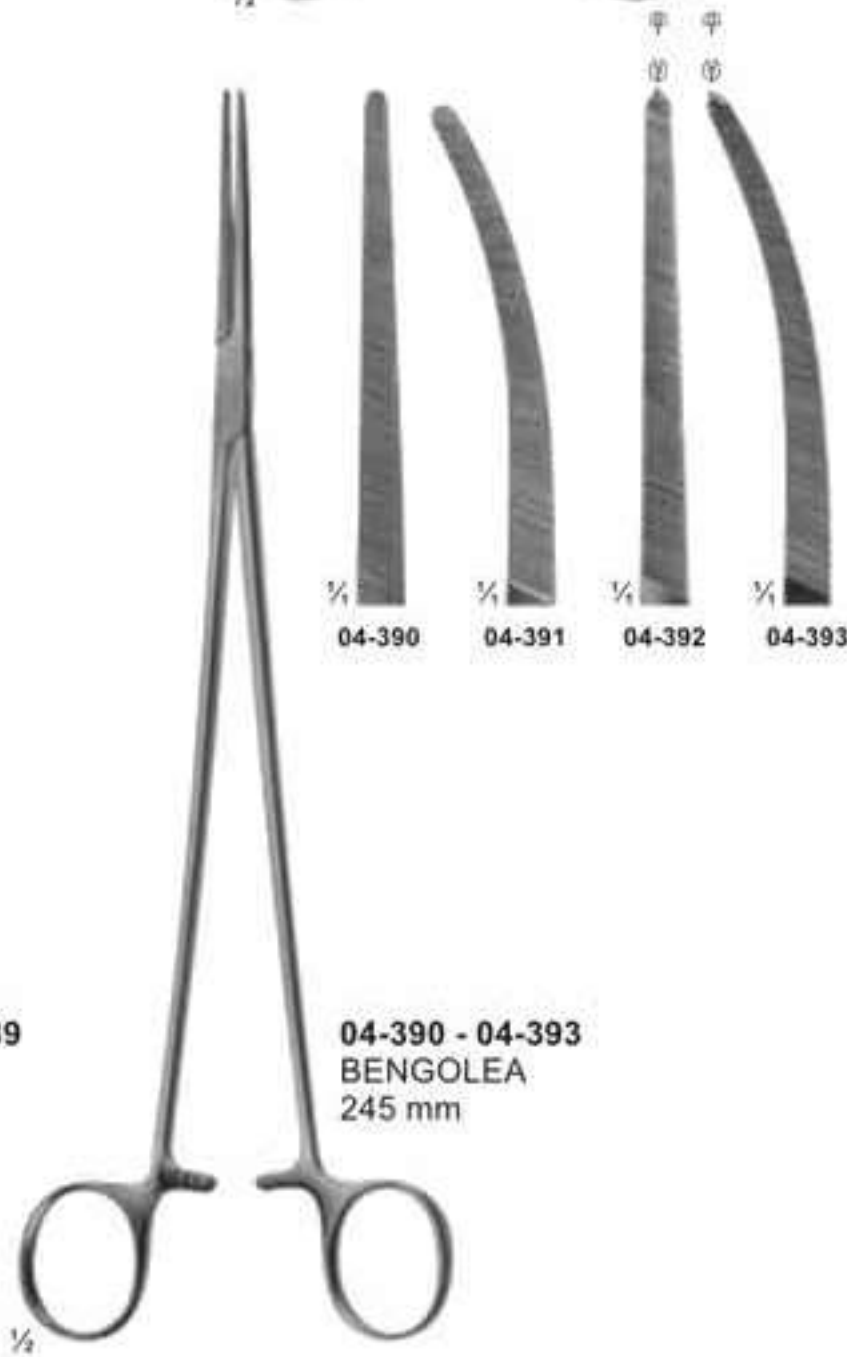

04-390 - 04-393  
BENGOLEA  
245 mm



04-394  
CRAFOORD  
245 mm

## Delicate Haemostatic Forceps



**04-395**  
CARREL  
85 mm



**04-396 - 04-399**  
BABY-MOSQUITO  
(HARTMANN)  
100 mm



**04-400 - 04-403**  
MICRO-HALSTED  
125 mm



**04-404 - 04-407**  
HALSTED-MOSQUITO  
125 mm

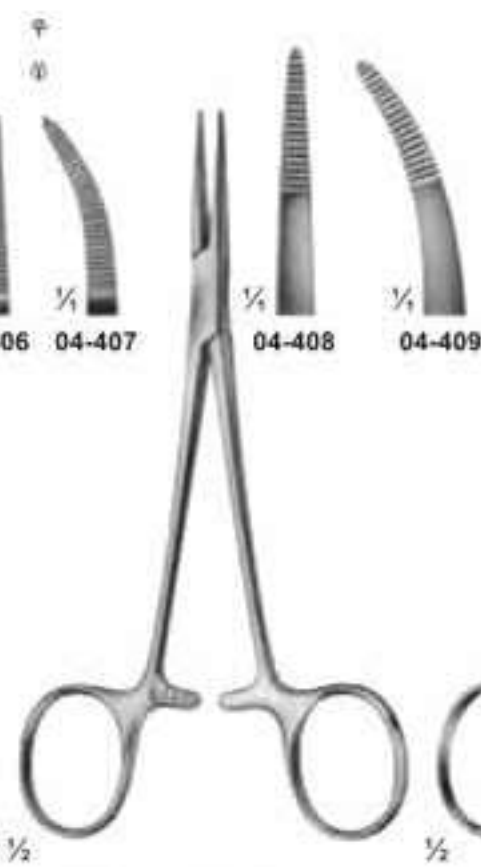

**04-408 - 04-409**  
PROVIDENCE-HOSPITAL  
140 mm

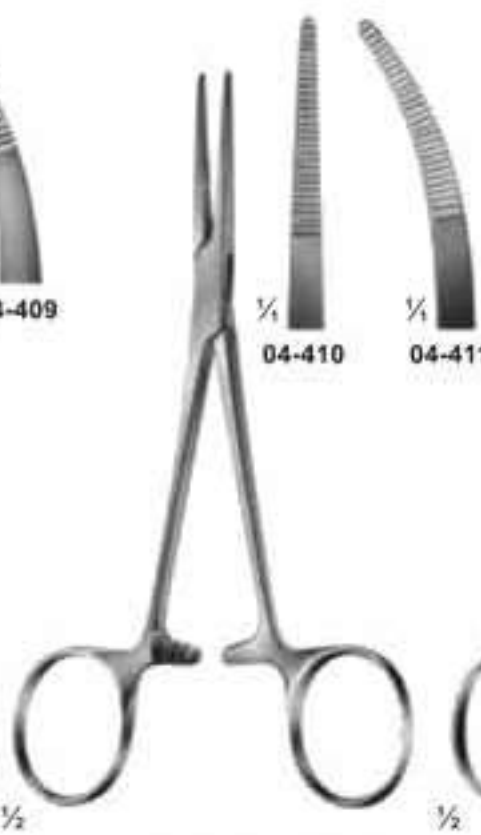

**04-410 - 04-411**  
KELLY  
140 mm

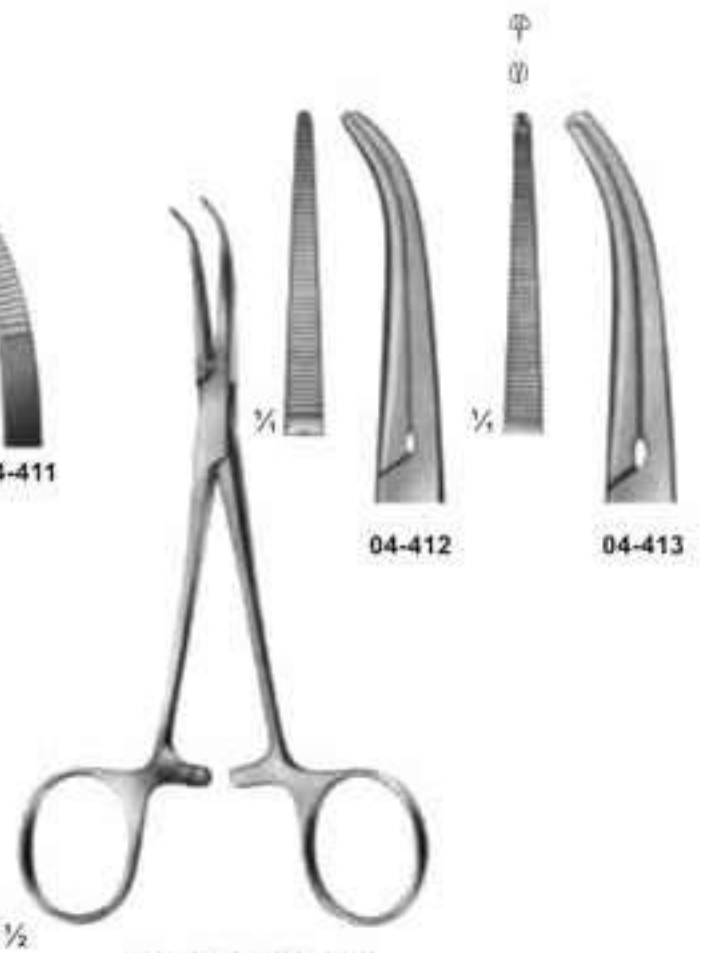

**04-412 - 04-413**  
DANDY  
Curved sideways  
140 mm

## Delicate Haemostatic Forceps

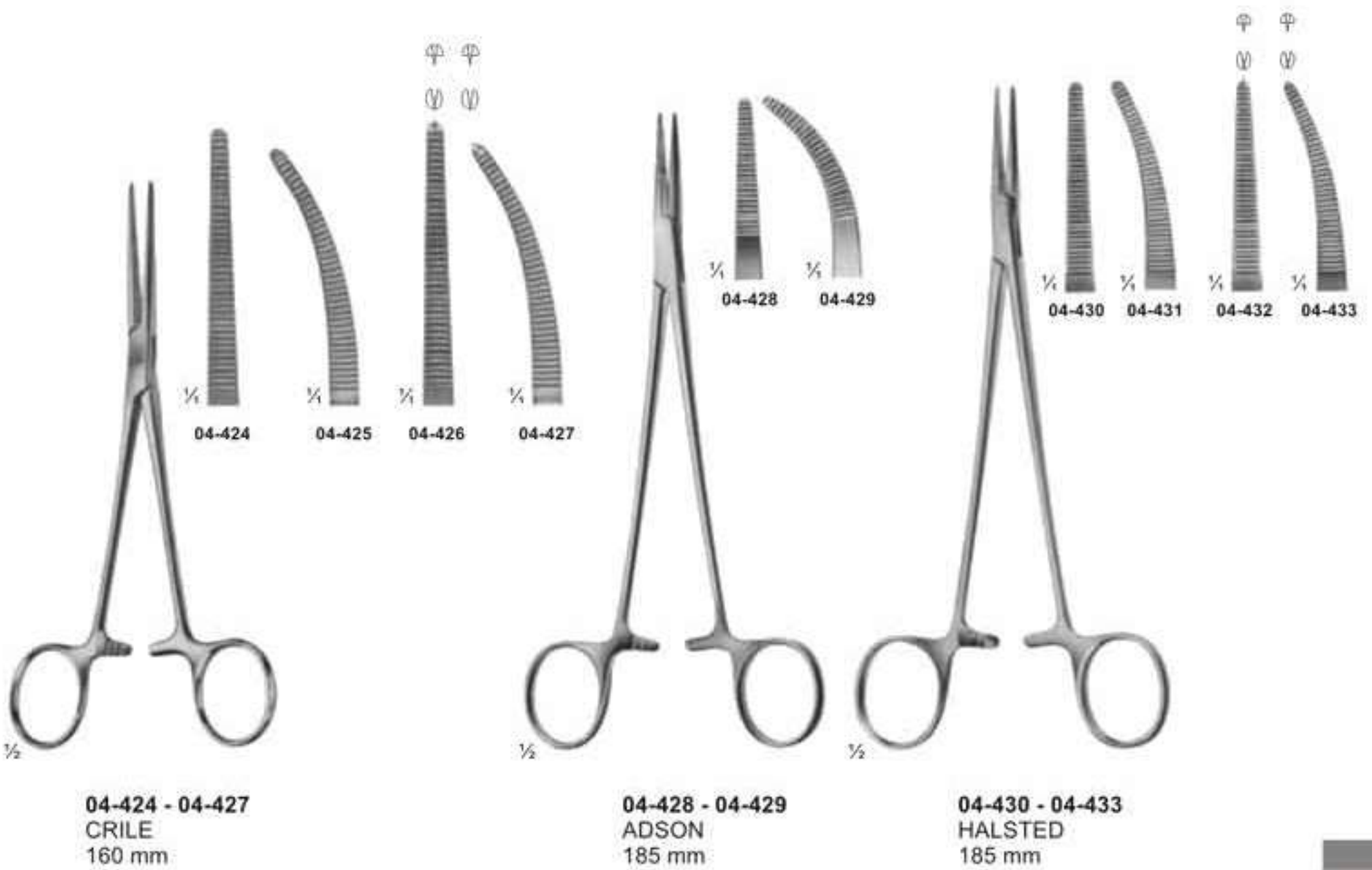
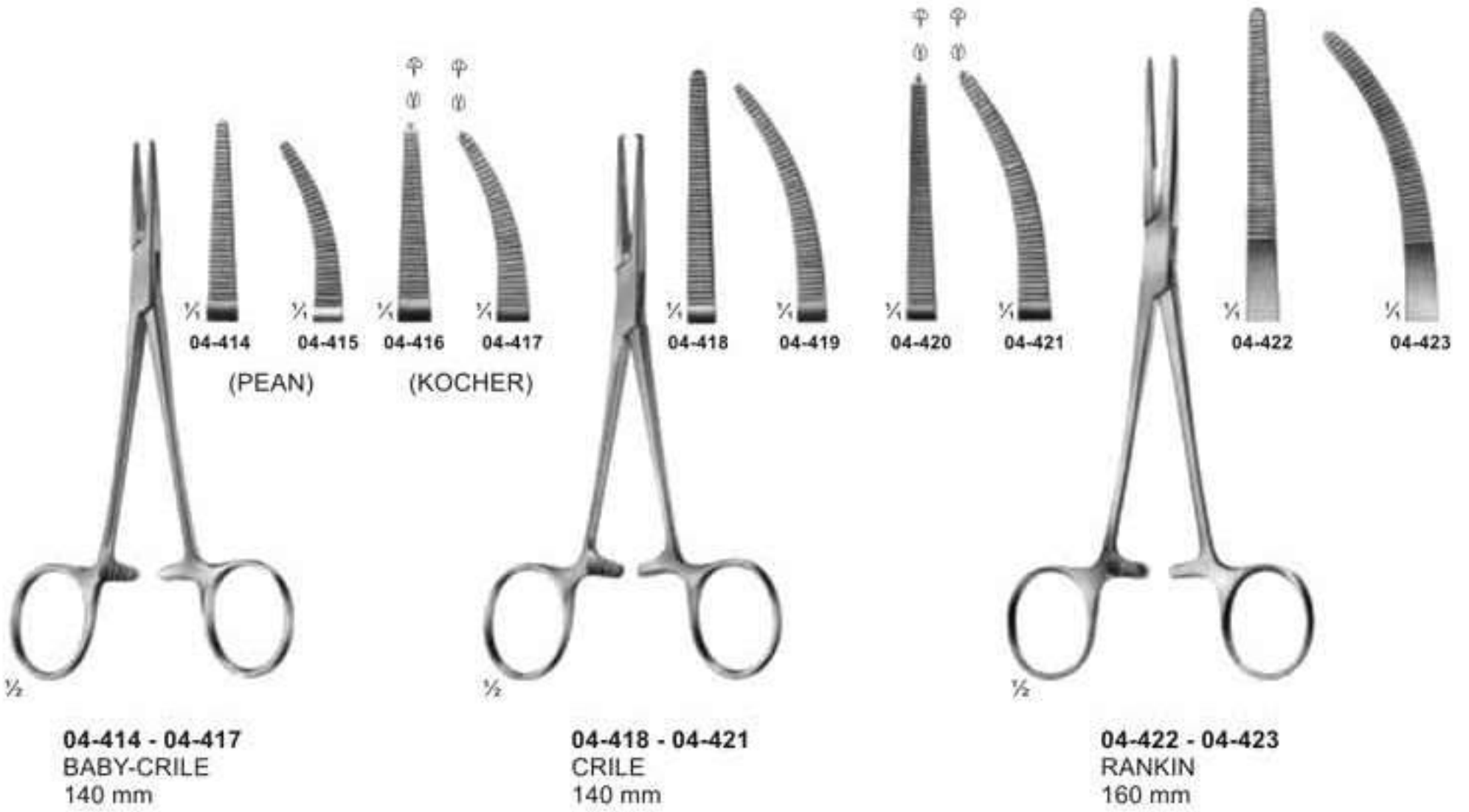

# Haemostatic Forceps



**04-434 - 04-437**  
PEAN  
Slender type

**04-438 - 04-445**  
SPENCER-WELLS  
Slender type

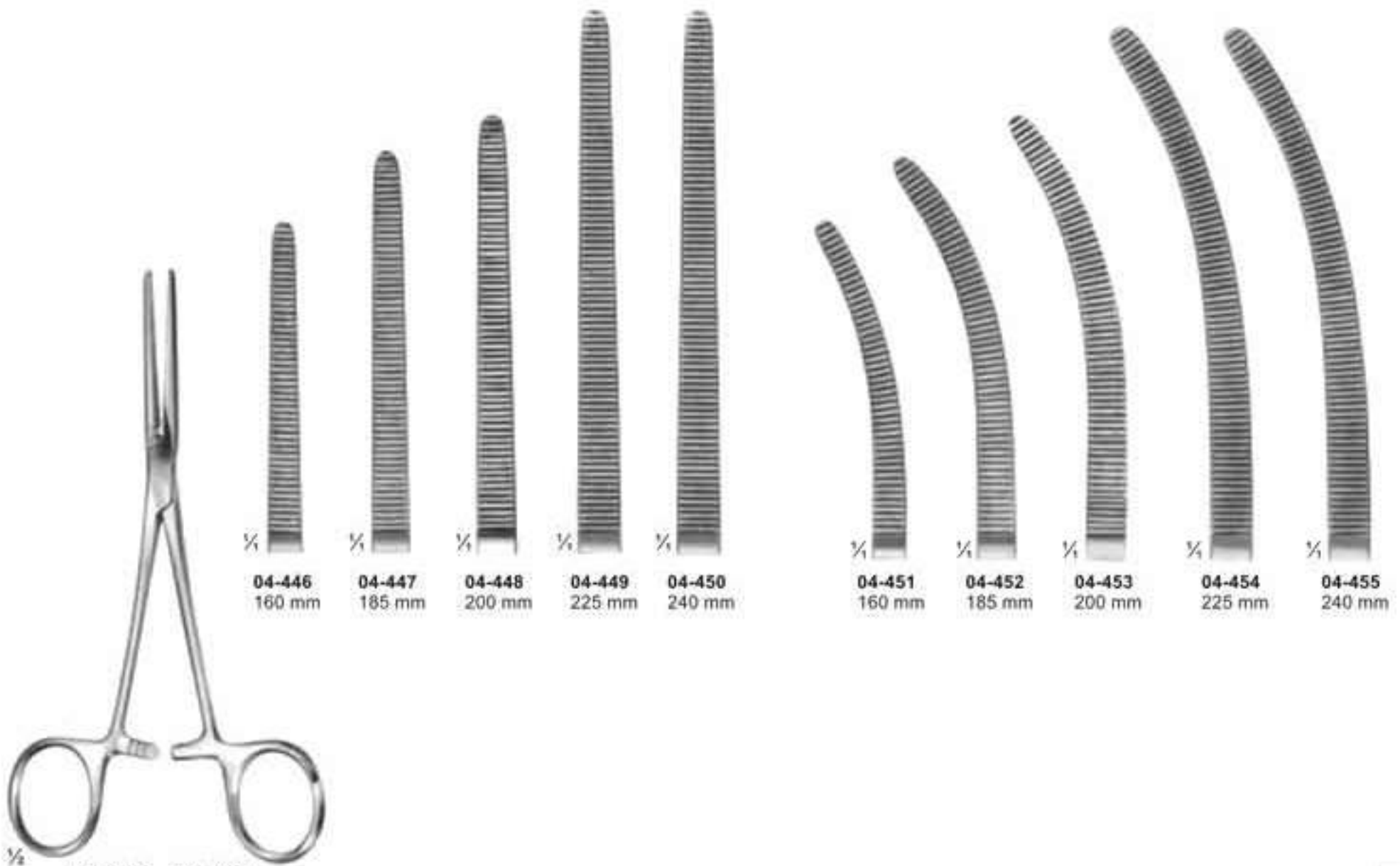

**04-446 - 04-455**  
ROCHESTER-PEAN



# Haemostatic Forceps



**04-456 - 04-461**  
PEAN

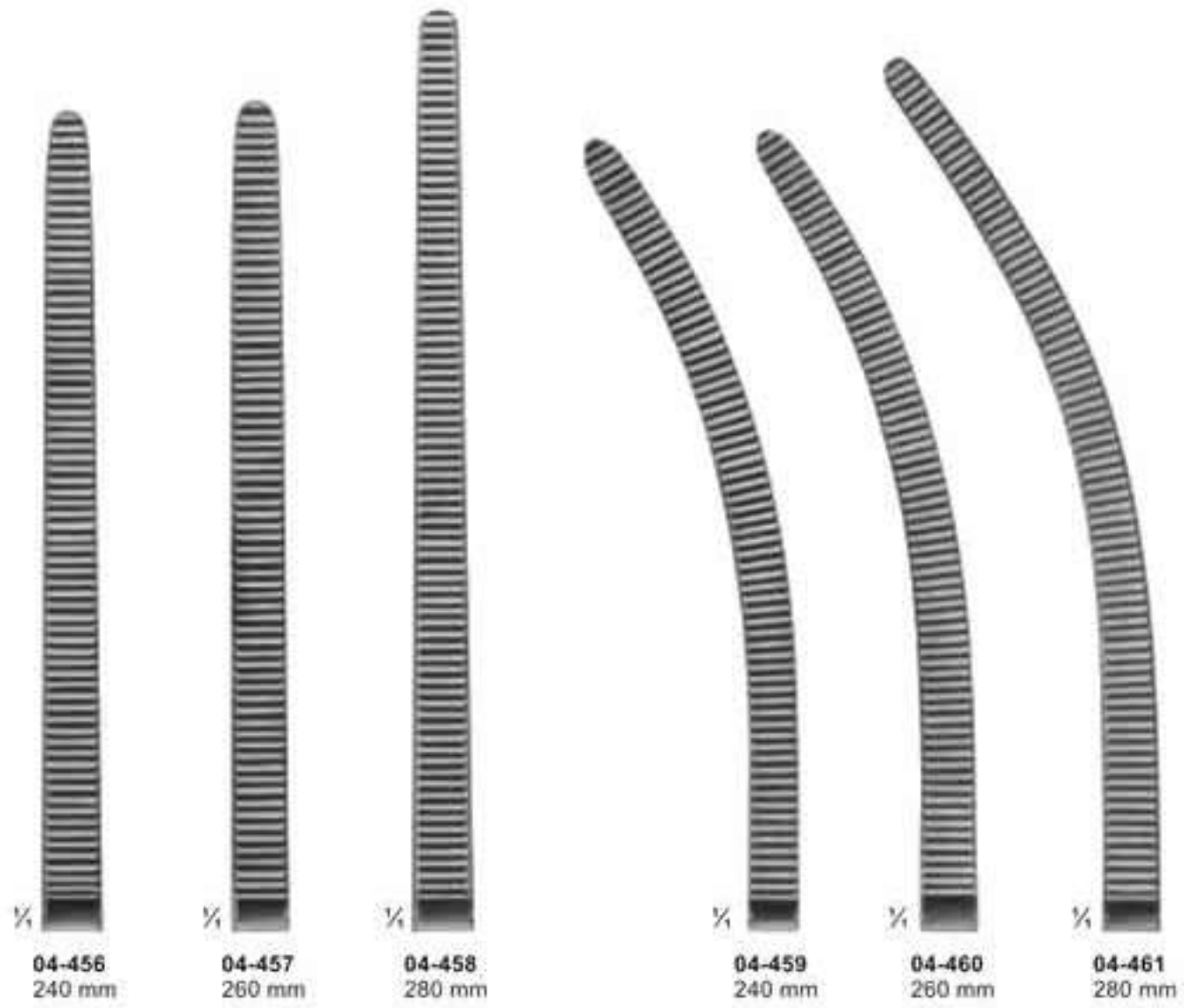

**04-462**  
KOCHER  
Strong Pattern  
145 mm



**04-463 - 04-465**  
KOCHER

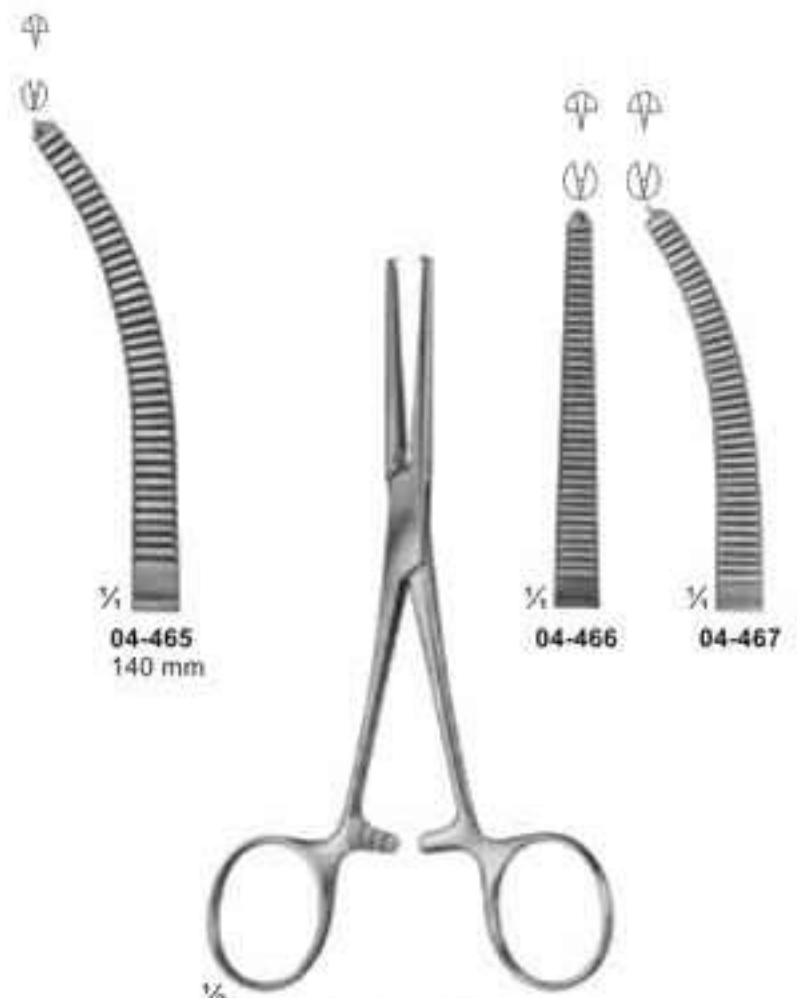

**04-466 - 04-467**  
ROCHESTER-OCHSNER  
140 mm

# Haemostatic Forceps

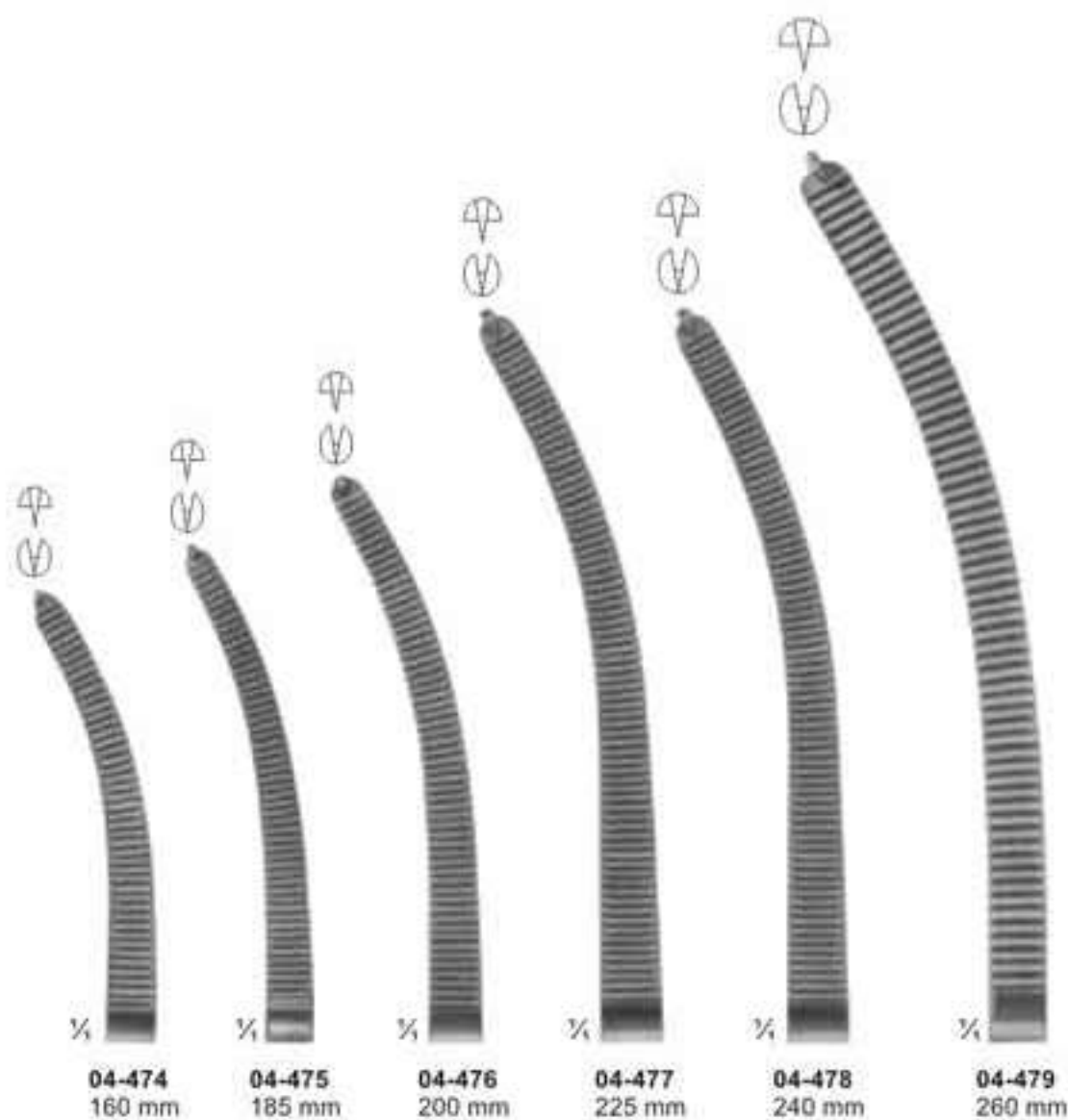
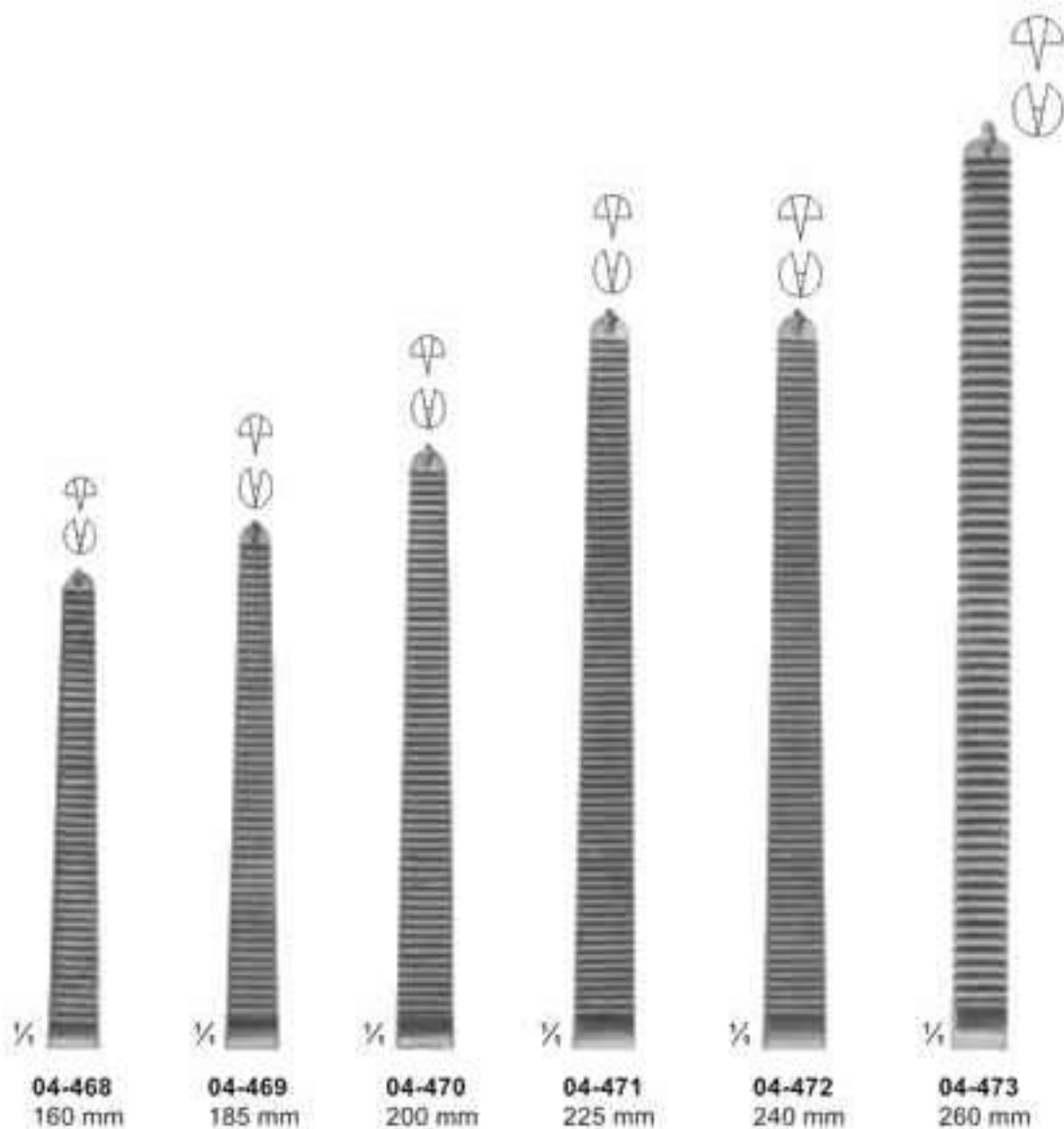

04-468 - 04-479  
KOCHER-OCHSNER

## Haemostatic Forceps

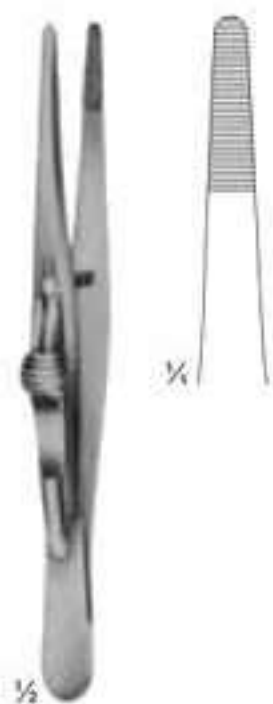

**04-480**  
FRICKE  
Artery forceps  
130 mm



**04-481**  
KRONLEIN  
130 mm



**04-482**  
PEAN  
125 mm



**04-483 - 04-484**  
PEAN



**04-485**  
PEAN  
125 mm

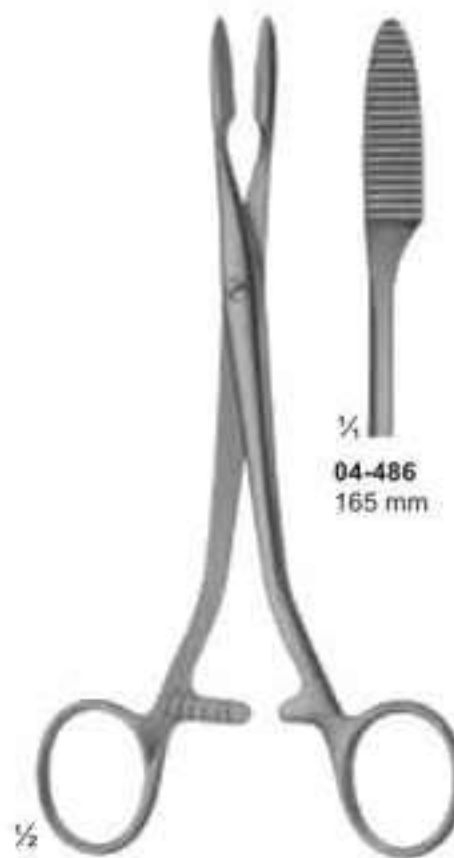

**04-486 - 04-487**  
PEAN



# Haemostatic Forceps, Special Pattern, Tonsil Forceps

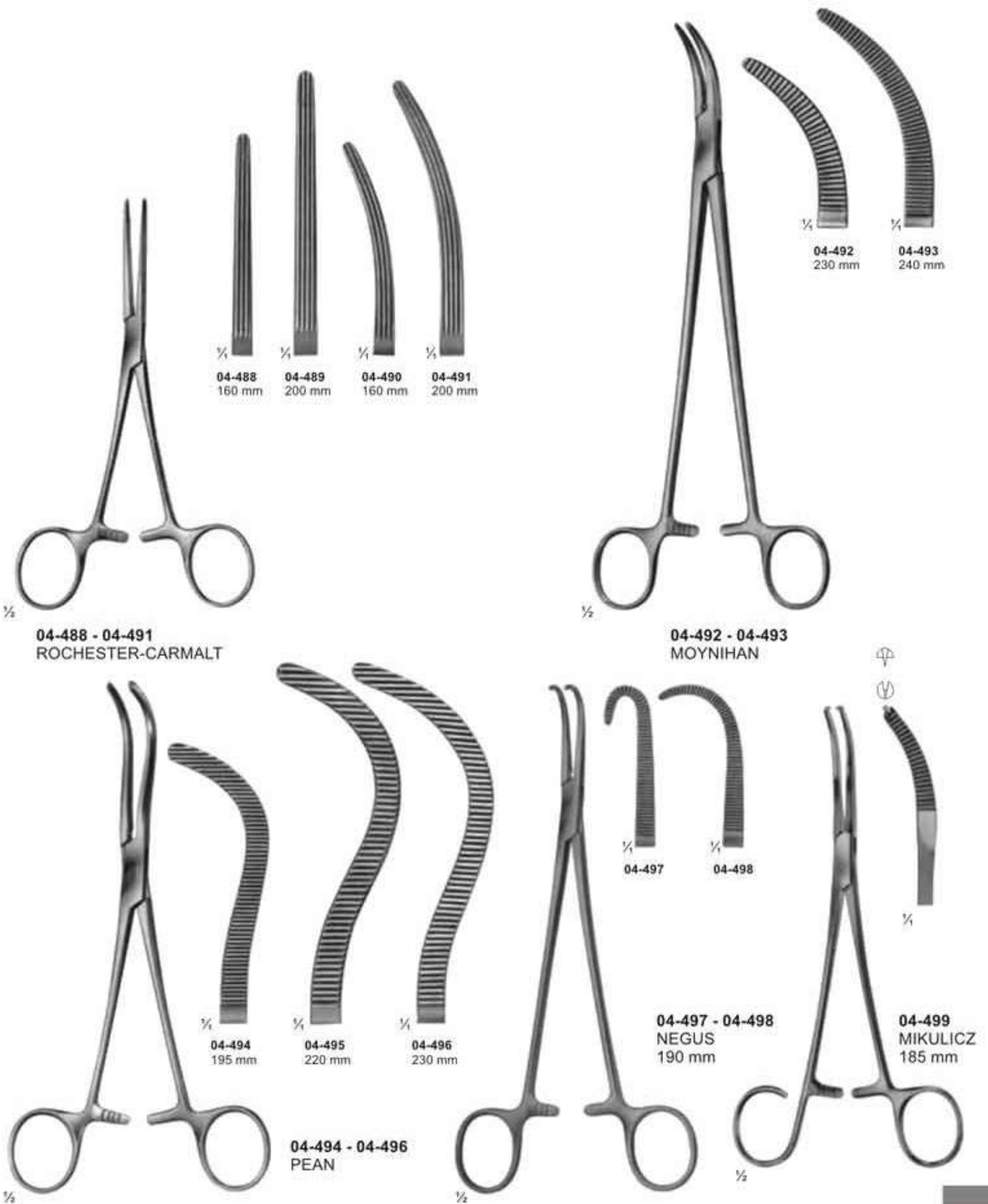

## Dissecting- and Ligature Forceps



**04-500**  
MIXTER-O'SHAUGNESSY  
190 mm



**04-501**  
HEISS  
195 mm

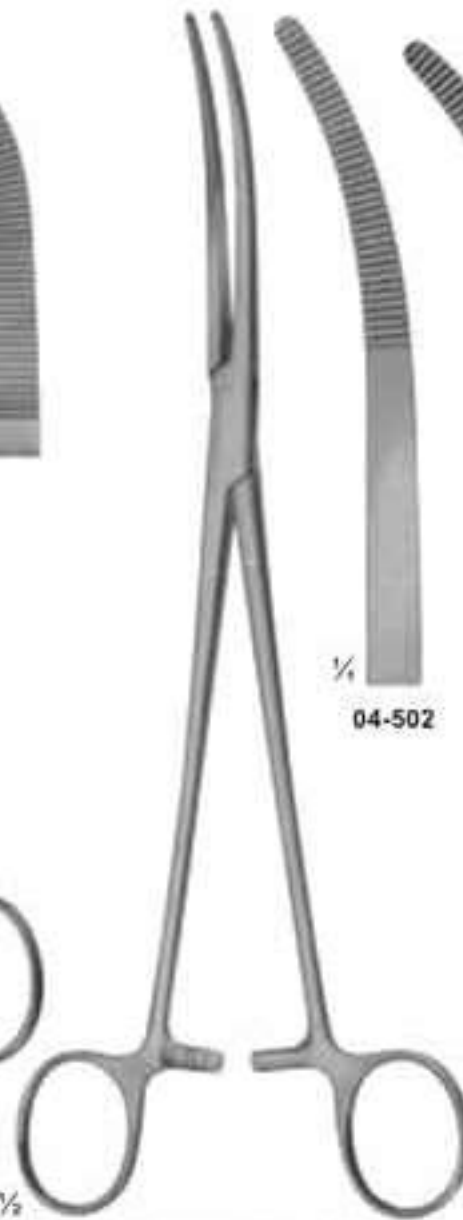

**04-502 - 04-506**  
RUMEL  
240 mm

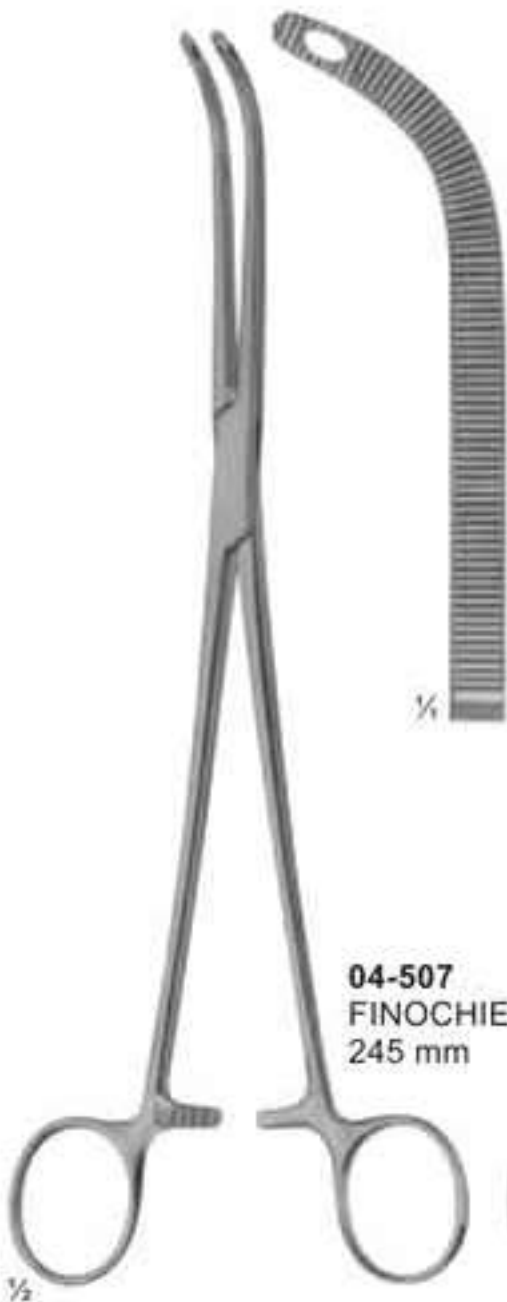
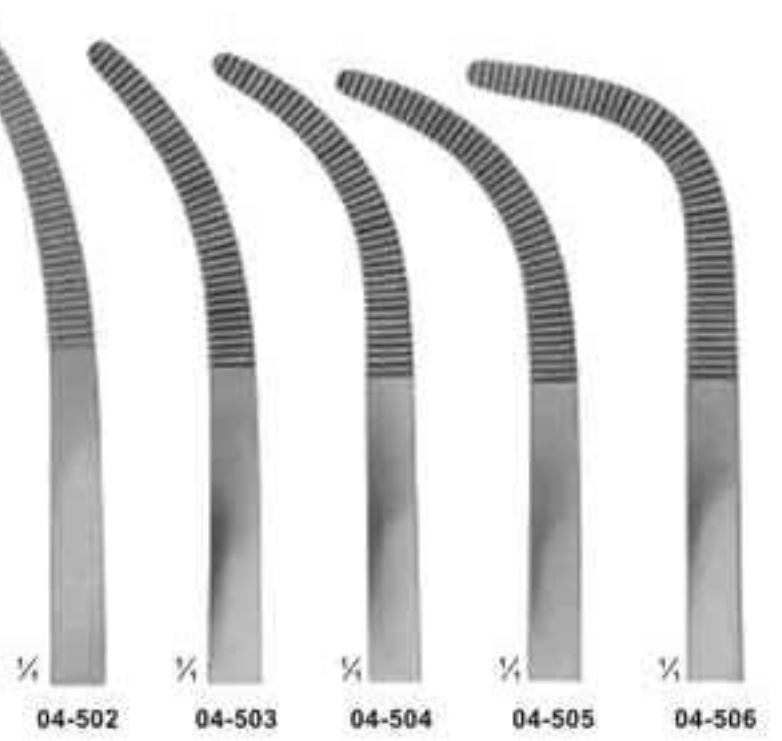

**04-507**  
FINOCHIETTO  
245 mm



**04-508**  
MIXTER  
230 mm



**04-509**  
LAWRENCE  
270 mm



**04-510 - 04-511**  
ZENKER

Hysterectomy Forceps, Vaginal Clamps  
and Compression Forceps

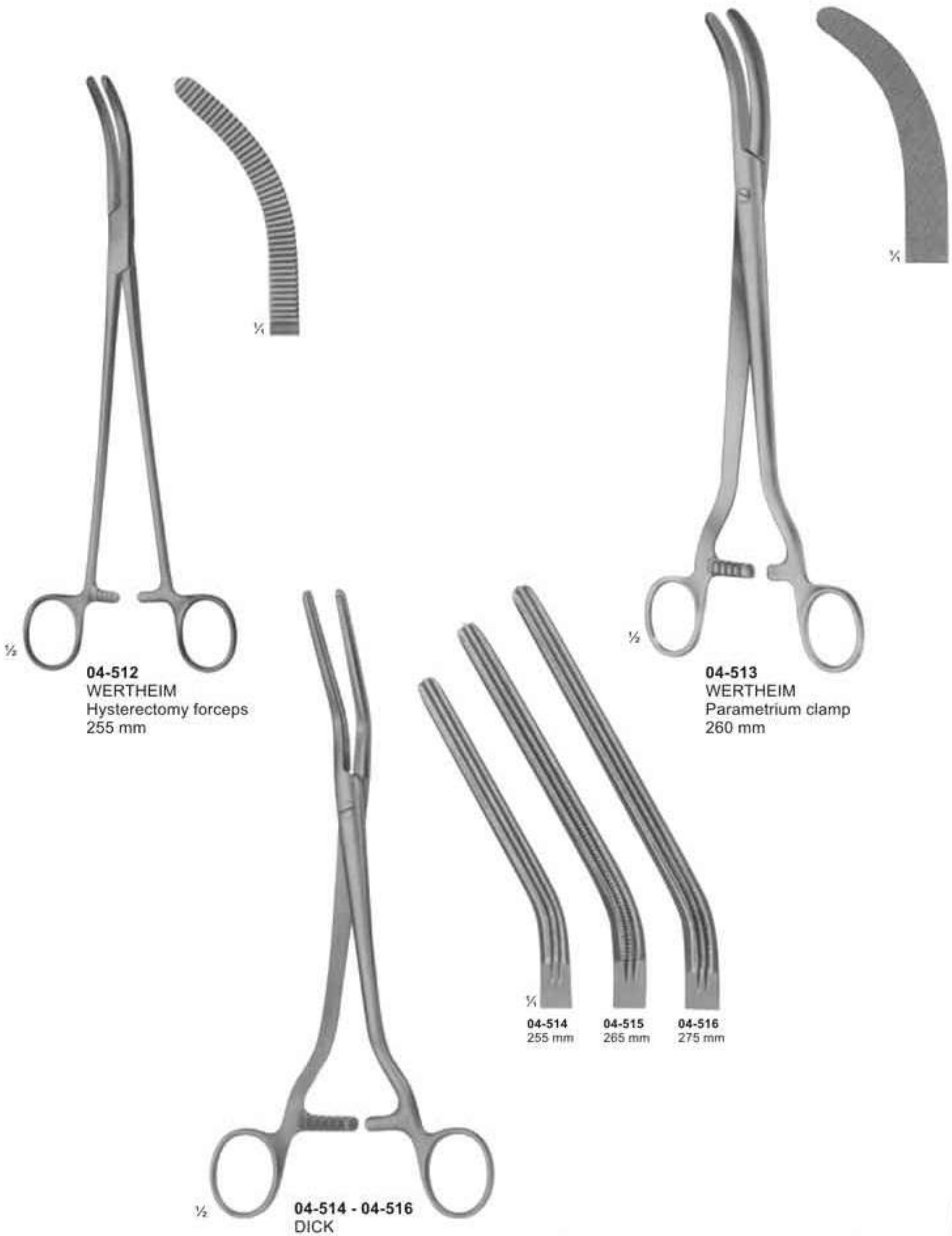

# Hysterectomy Forceps, Vaginal Clamps and Compression Forceps



## Needle Holders for micro surgery

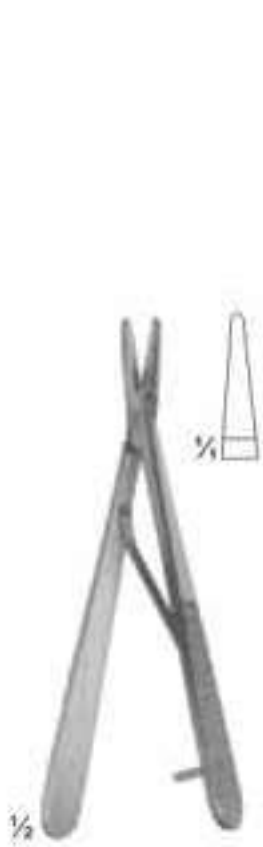

**05-101**  
**ROHRSCHEIDER**  
with copper inserts  
100 mm



**05-102**  
**KALT**  
with catch  
135 mm



**05-103**  
**ARRUGA**  
with catch  
135 mm



**05-104 - 105**  
**CASTROVIEJO**  
with catch  
145 mm



**05-106 - 107**  
without Catch  
160 mm



**05-108 - 109**  
without catch  
185 mm

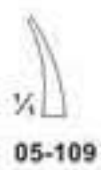

**05-109**



**05-110 - 111**  
**JACOBSON**  
185 mm

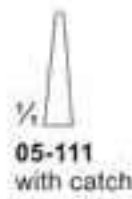

**05-110**  
without catch

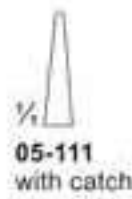

**05-111**  
with catch



**05-112**  
without catch  
195 mm



**05-113 - 114**  
**YASARGIL**  
with catch  
200 mm



# Needle Holders

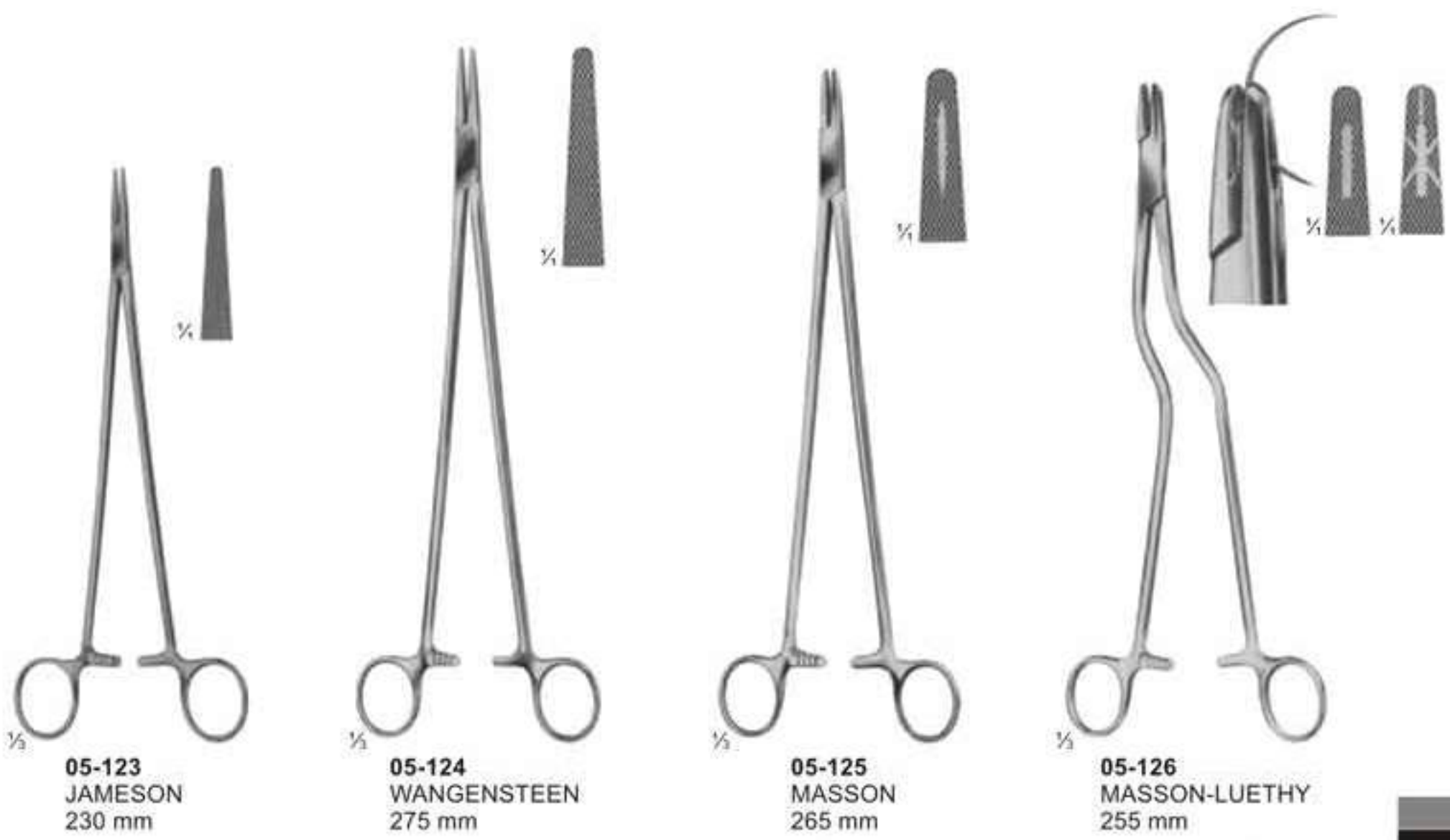

## Needle Holders

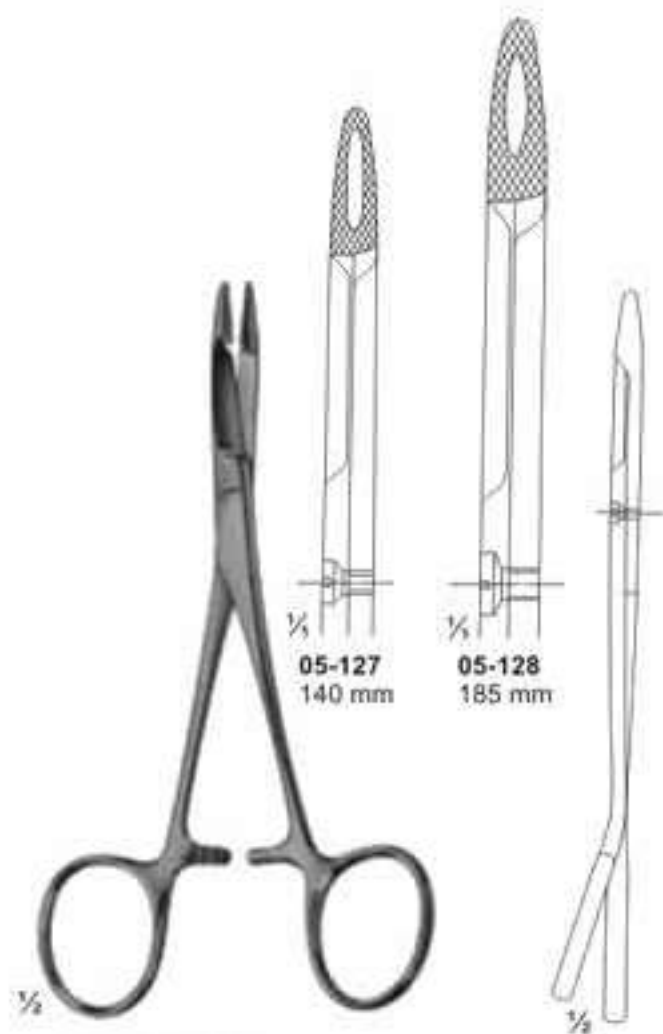

**05-127 - 128**  
HEGAR-OLSEN  
255 mm

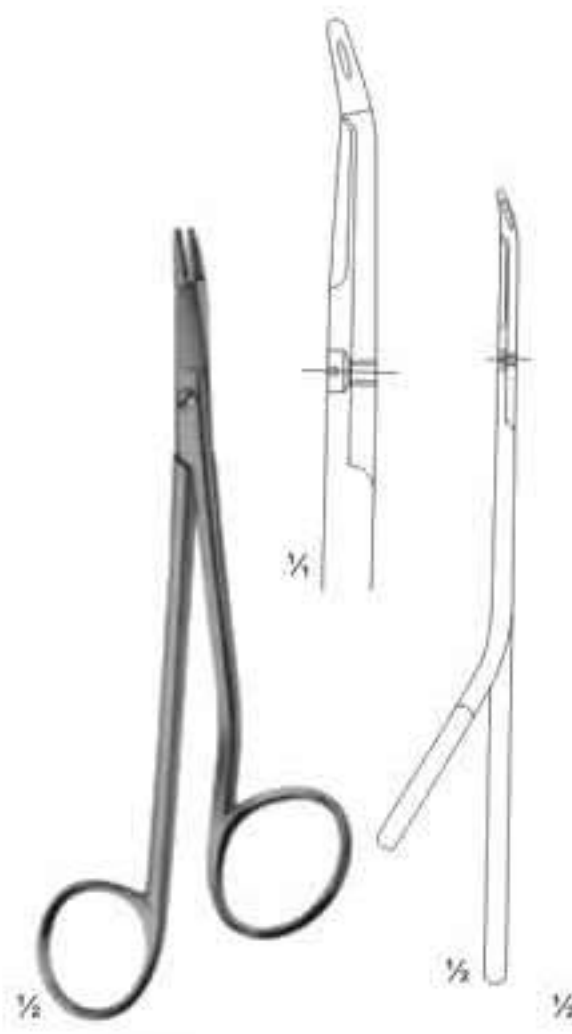

**05-129**  
GILLIES  
150 mm



**05-130**  
GILLIES  
160 mm

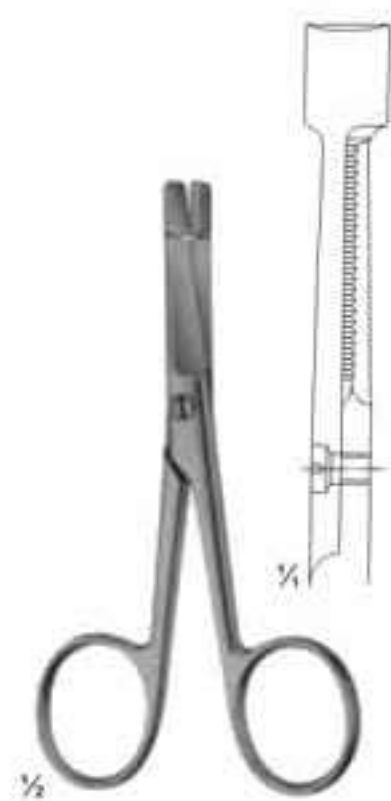

**05-131**  
EISELSBERG  
115 mm

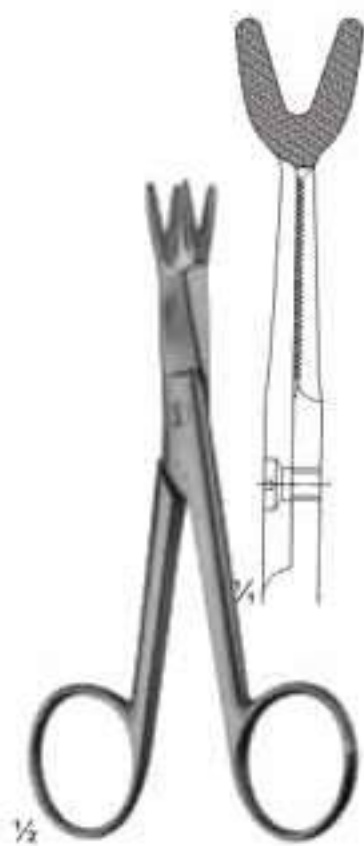

**05-132**  
SCHOEMAKER-LOTH  
125 mm



**05-133**  
CRILE  
150 mm



**05-134**  
TOENNIS  
Elastic pattern for dura-or  
intestinal suture. 180 mm

# Needle Holders

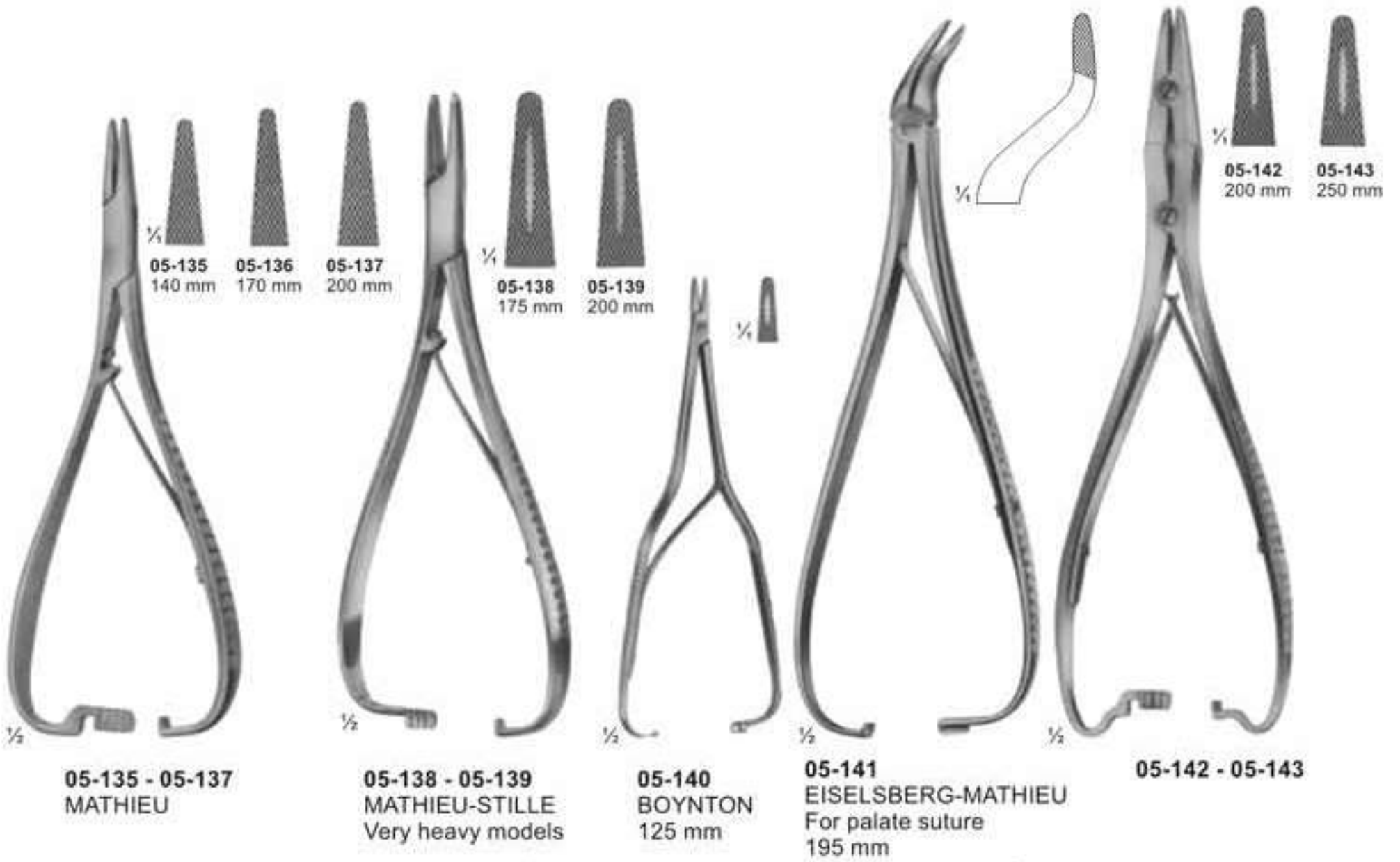

## Suture Instruments - Reverdin Needles

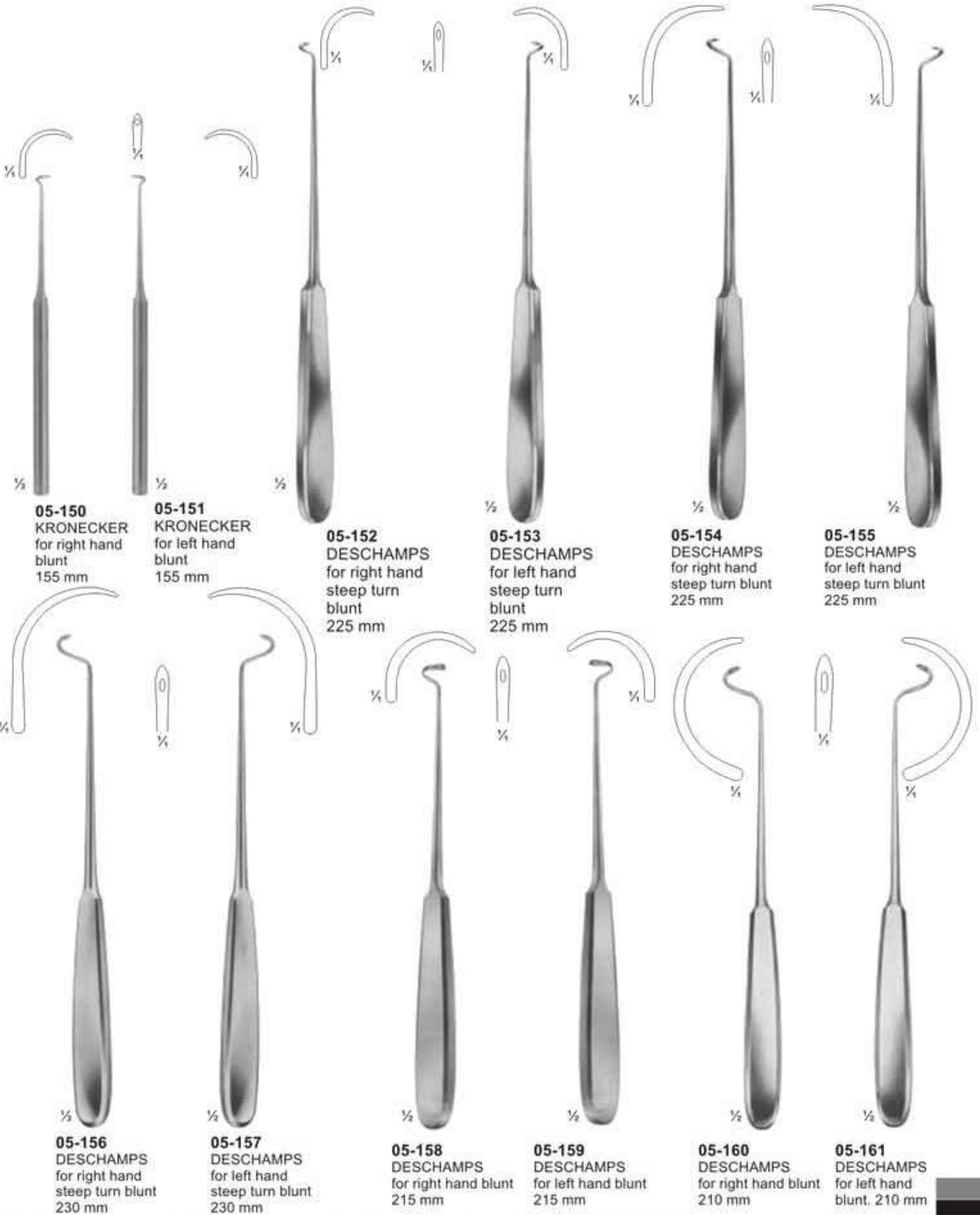

Probes



**05-162** 130 mm  
**05-163** 145 mm  
**05-164** 160 mm  
Directors



**05-165**  
**DOYEN**  
145 mm  
Directors



**05-166**  
**NELATON**  
160 mm  
Directors



**05-167**  
Director with tip  
Diam. Of tip 3,3 mm  
140 mm



**05-168**  
**BRODIE**  
Director with tip,  
Diam. Of tip 3,5 mm  
200 mm



**05-169**  
**LOCKHART-MUMMERY**  
165 mm



**05-170**  
**LOCKHART-MUMMERY**  
165 mm

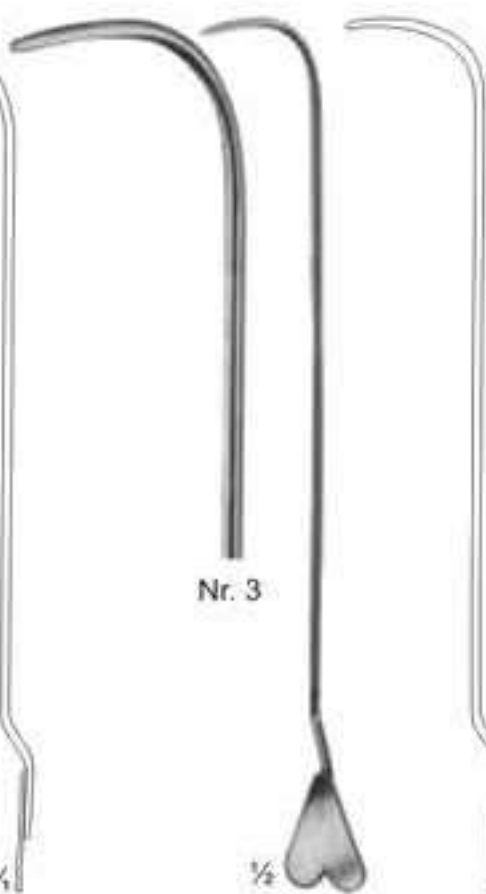

**05-171**  
**LOCKHART-MUMMERY**  
165 mm

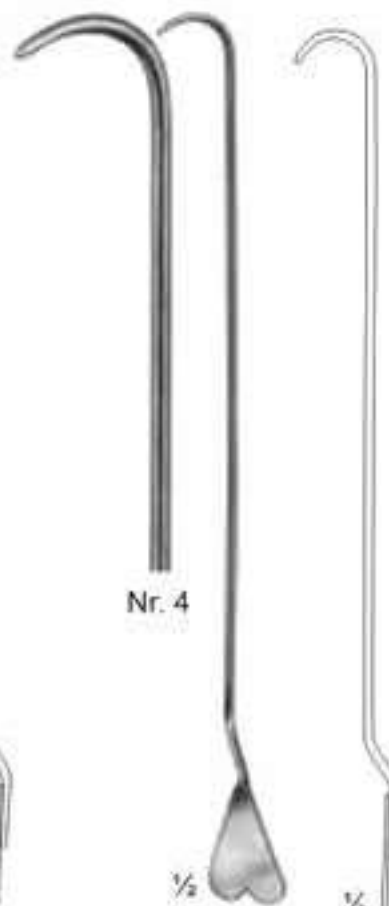

**05-172**  
**LOCKHART-MUMMERY**  
165 mm



**05-173**  
Director with wire  
loop, malleable  
190 mm

# Probes



05-174 145 mm  
05-175 160 mm  
05-176 200 mm  
Probes with eye



05-177  
Myrtle leaf probe  
145 mm



05-178 130 mm  
05-179 145 mm  
05-180 160 mm  
05-181 180 mm  
05-182 200 mm



05-183  
Probes



05-184  
Double ended probe,  
malleable, diam. of tips  
3 mm with hole  
190 mm



05-185  
Double ended probes,  
tin, malleable,  
diam. of tips  
3,5 mm with hole  
250 mm, 300 mm



05-186  
Double ended probes,  
tin, malleable,  
diam. of tips 4 mm  
400 mm



05-187 1,5 mm  
05-188 2,0 mm  
05-189 2,5 mm  
300 mm

## Suturing Instrument Set, Pocket Instrument Set



### 05-190

Suturing instruments set, in metal case consisting of: Scissors, curved, sharp/sharp, 115mm  
25 MICHEL clip, 16 x 3mm  
1 Delicate tissue forceps, 130mm  
1 Scalpel, bellied  
1 MATHIEU needle holder, 140mm  
1 Perforated metal case, stainless containing:  
1 Suture needle  
1 item 1 item



### 05-191

Pocket instrument set, in metal case consisting of:

#### Bottom tray

1 MATHIEU needle holder, 140mm  
1 MICHEL clip forceps, combined  
1 Myrtle leaf probe, 130mm  
1 Sharp double curette  
1 Skin hook  
1 Detachable scalpel handle, no.4  
1 Perforated metal case, containing  
6 Scalpel blades  
1 Perforated metal case, stainless, containing  
1 Suture needle  
1 item  
1 item



#### Top tray

1 Tissue forceps, 130mm  
1 KOCHER haemostatic forceps, 130mm  
1 Straight surgical scissors, 130mm  
1 Dissecting forceps, 130mm  
1 FEILCHENFELD splinter forceps, 115mm  
25 MICHEL clip, 16 x 3mm  
1 Flacon of suture skin, sterile in alcohol



### 05-192

Pocket instrument set, in metal case consisting of:

#### Bottom tray

1 MAYO-HEGER needle holder, 150mm  
1 MICHEL clip forceps, combined  
1 Myrtle leaf probe, 130mm  
1 Sharp double curette  
1 Skin hook  
1 Detachable scalpel handle, no. 4  
1 Perforated metal case, consisting  
6 Scalpel blades  
1 Perforated metal case, stainless, consisting:  
1 Suture needle  
1 item, & 1 item

#### Top tray

1 Tissue forceps, 130mm  
1 CRILE haemostatic forceps, 140mm  
1 Straight surgical scissors, 130mm  
1 Dissecting forceps, 130mm  
1 FEILCHENFELD splinter forceps, 115mm  
25 MICHEL clip, 16 x 3mm  
1 Flacon of suture silk, sterile in alcohol

## Fine Wound Retractors (Dura- and Skin Retractors)

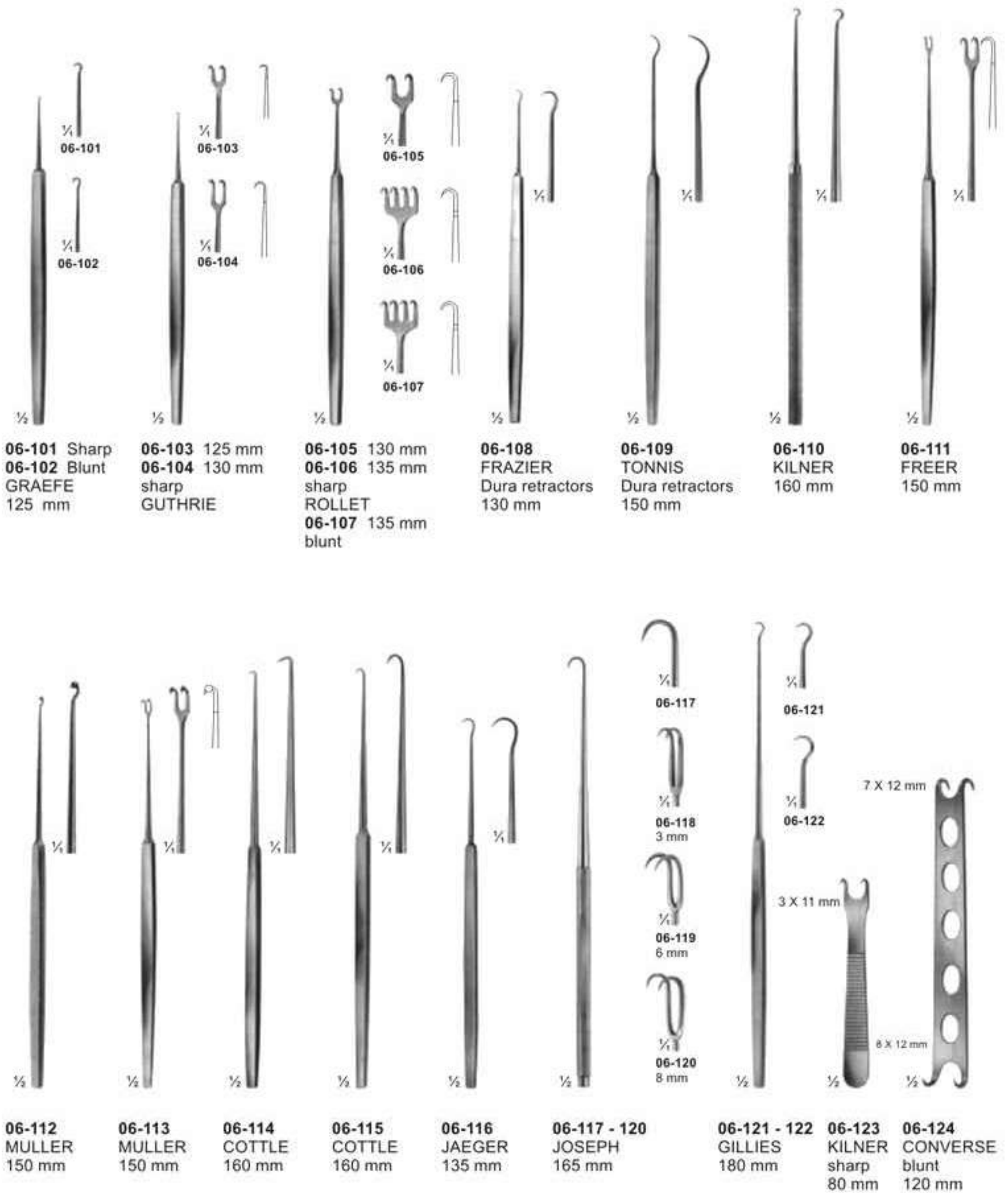



## Retractors With treangle handle

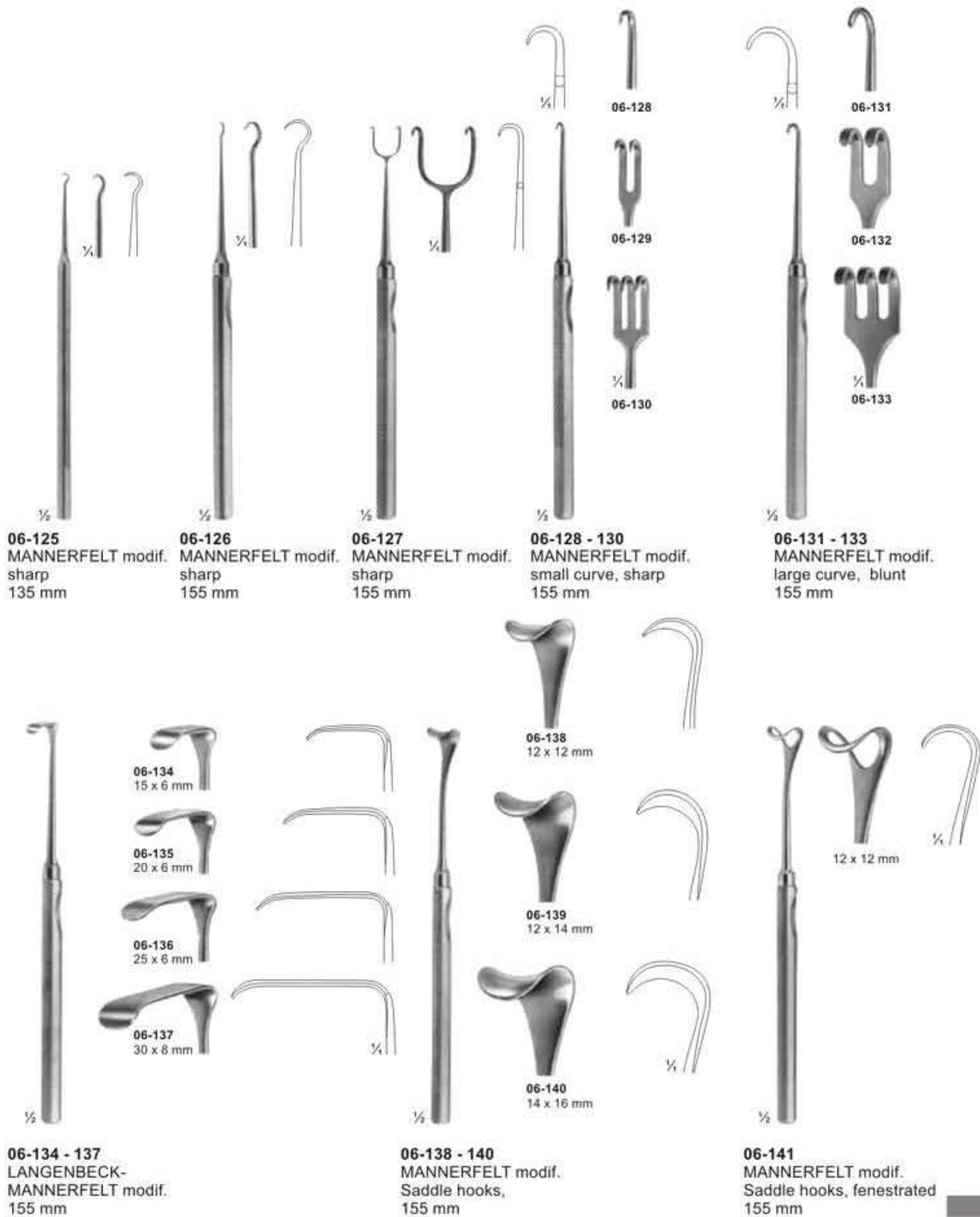

# Retractors



1/4  
6 x 12 mm

1/2  
**06-142**  
MASING  
140 mm



1/4  
10 x 12 mm

1/2  
**06-143**  
COTTLE  
140 mm



**06-144**  
9 x 9 mm



**06-145**  
9 x 12 mm



1/4  
**06-146**  
11 x 14 mm



**06-147**  
12 x 16 mm



1/4  
**06-148**  
13 x 18 mm

1/2  
**06-144 - 148**  
DESMARRES  
140 mm



1/4  
**06-149**  
13 x 13 mm



1/4  
**06-150**  
12 x 16 mm

1/2  
**06-149 - 150**  
KONIG  
180 mm



1/4  
10 x 10 mm

1/2  
**06-151**  
CUSHING-KOCHER  
175 mm



1/2  
**06-152 - 153**  
KOCHER  
205 mm



1/4  
**06-152**  
20 x 12 mm



1/4  
**06-153**  
20 x 15 mm



1/2  
**06-154**  
SCHOENBORN  
200 mm



1/4  
13 x 6 mm



1/2  
**06-155 - 156**  
CUSHING  
205 mm



1/4  
**06-155**  
10 x 13 mm



1/4  
**06-156**  
14 x 18 mm



1/2  
**06-157**  
205 mm

20 x 15 mm

20 x 19 mm



1/2  
**06-158 - 160**  
CUSHING  
250 mm



1/4  
**06-158**  
11 x 14 mm



1/4  
**06-159**  
13 x 18 mm



1/4  
**06-160**  
15 x 22 mm

# Retractors

 <p>1/2</p>	 <p>19 x 22 mm</p> <p>1/4</p>	 <p>25 x 26 mm</p> <p>1/4</p>	 <p>28 x 29 mm</p> <p>1/4</p>	 <p>1/2</p>	 <p>20 x 22 mm</p> <p>1/4</p>	 <p>25 x 26 mm</p> <p>1/4</p>
<p><b>06-161 - 163</b> ROUX Set 165 mm</p>	<p><b>06-161</b> 23 x 30 mm</p>	<p><b>06-162</b> 28 x 38 mm</p>	<p><b>06-163</b> 33 x 45 mm</p>	<p><b>06-164 - 165</b> ROUX</p>	<p><b>06-164</b> 25 x 29 mm 150 mm</p>	<p><b>06-165</b> 30 x 38 mm 160 mm</p>
 <p>1/2</p>	 <p>36 mm</p> <p>38 x 42 mm</p>	 <p>47 x 13 mm 41 x 13 mm</p> <p>37 x 25 mm 42 x 25 mm</p> <p>1/2</p>		 <p>26 x 15 mm 22 x 15 mm</p> <p>39 x 15 mm 43 x 15 mm</p> <p>1/2</p>		
<p><b>06-166</b> CZERNY 175 mm</p>	<p><b>06-167</b> MATHIEU 200 mm</p>	<p><b>06-168</b> US-ARMY 220 mm</p>				

# Retractors



## Bone Retractors and Retractors



**06-184**  
KOCHER  
sharp  
205 mm



**06-185**  
KOCHER  
sharp  
220 mm



**06-186**  
KOCHER  
sharp  
220 mm



**06-187**  
VOLKMANN  
blunt  
220 mm



**06-188**  
VOLKMANN  
sharp  
220 mm



**06-189 - 06-196**  
VOLKMANN  
225 mm



**06-189**  
9 x 8 mm



**06-190**  
9 x 13 mm



**06-191**  
9 x 19 mm



**06-192**  
9 x 29 mm



**06-193**  
8,5 x 8 mm



**06-194**  
8,5 x 13 mm



**06-195**  
8,5 x 19 mm



**06-196**  
8,5 x 29 mm

# Retractors

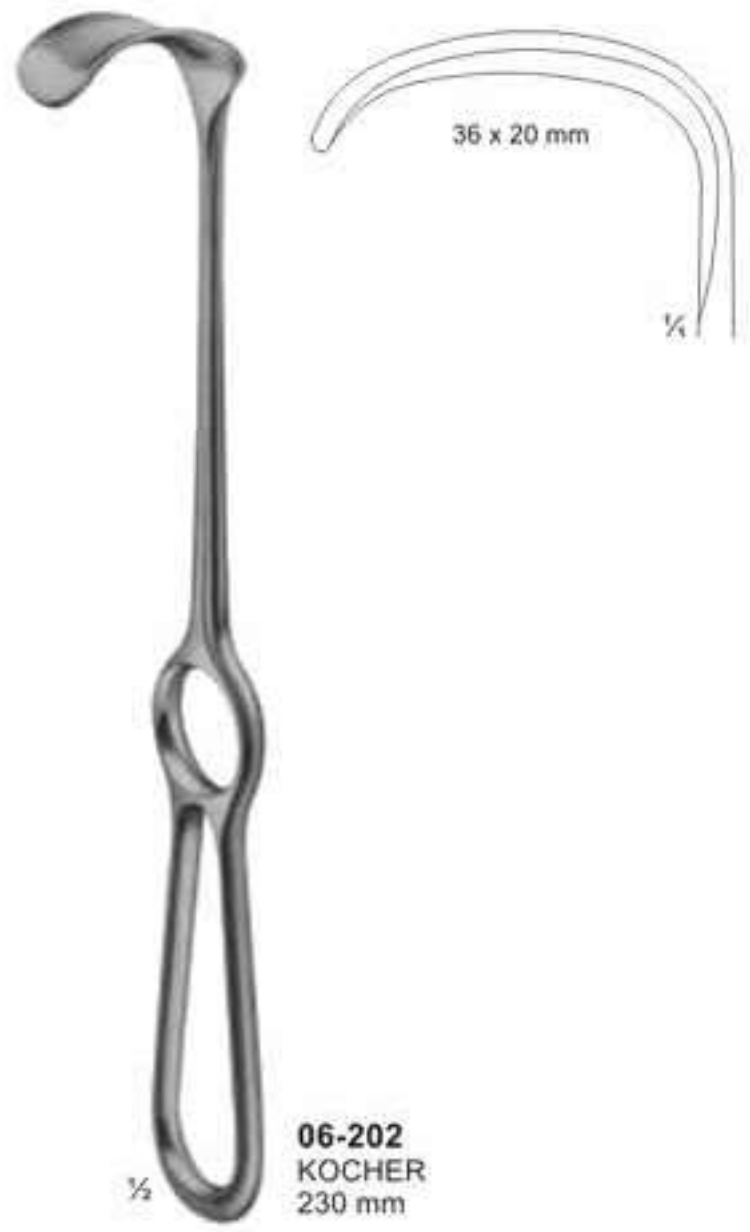
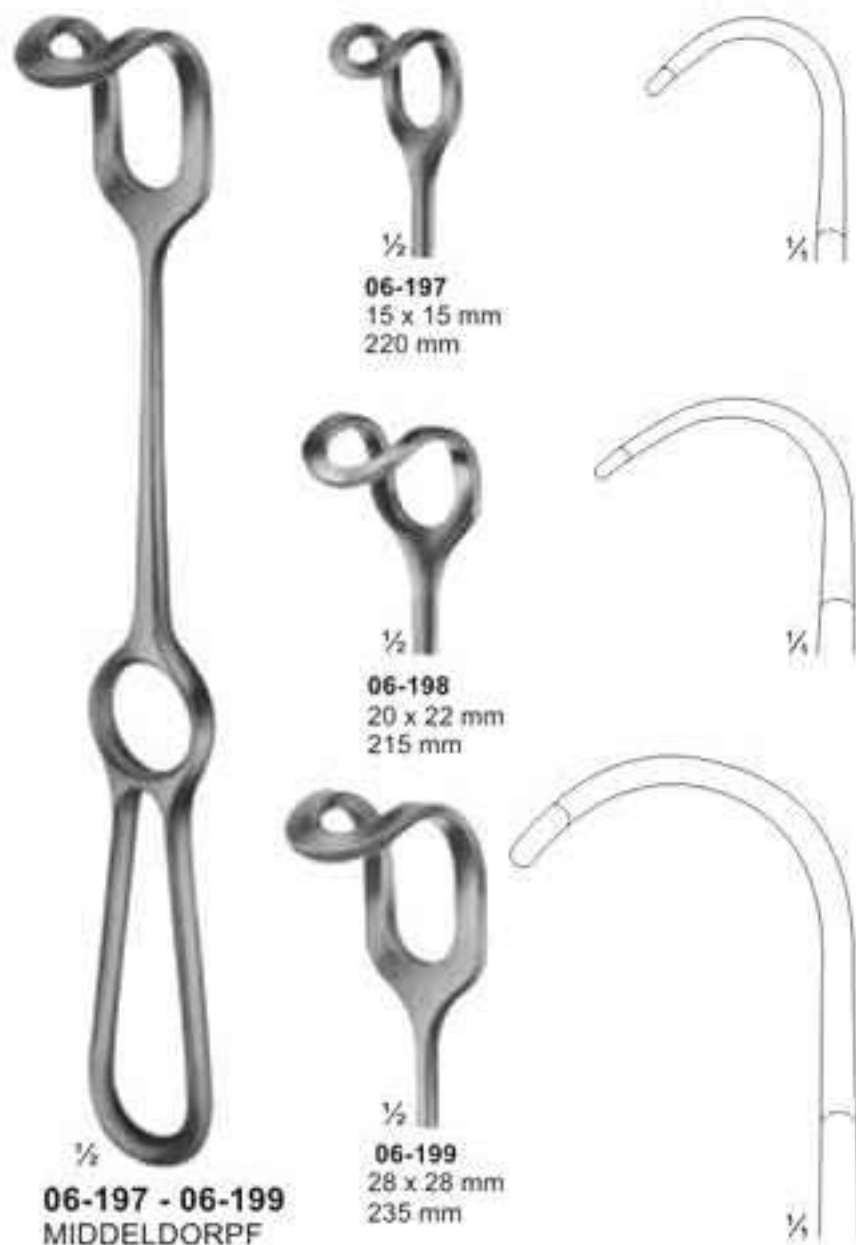

## Retractors, Vario Retractor System



- 06-203-06-209**  
BRUNNER  
275 mm
- 06-203 80 x 20
  - 06-204 100 x 25
  - 06-205 120 x 25
  - 06-206 130 x 30
  - 06-207 140 x 30
  - 06-208 160 x 30
  - 06-209 180 x 30  $\frac{1}{2}$



**06-210**  
Handle with cold light carrier for retractor blades, 280 mm



Handle arrangement verriable

# Retractors, Lung Spatulas





Retractors for deep surgery  
(Abdominal Retractors)

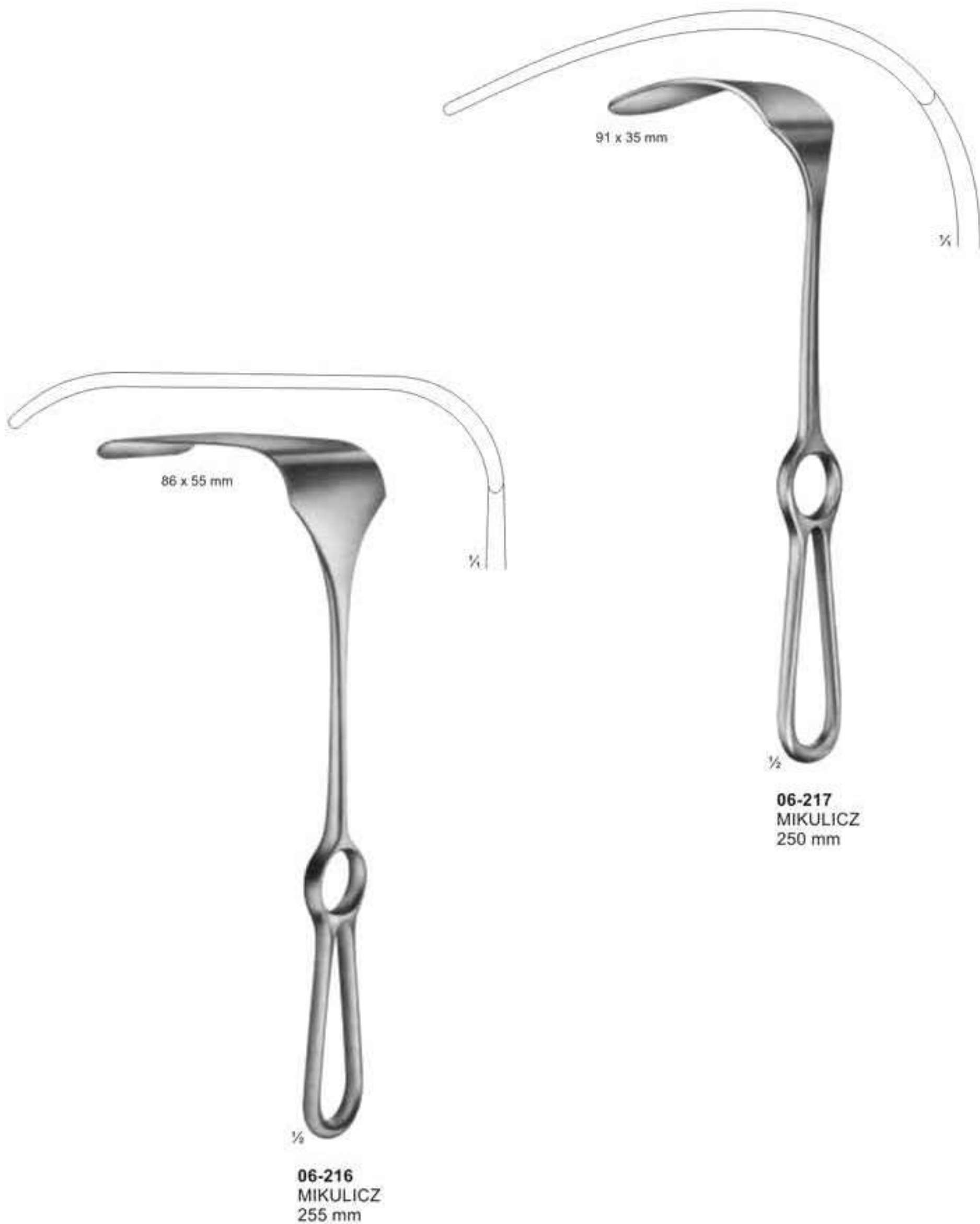

# Retractors, Abdominal Retractors



- 06-229 Fig.1 32 x 40 mm
- 06-230 Fig.2 34 x 50 mm
- 06-231 Fig.3 41 x 60 mm
- 06-232 Fig.4 46 x 75 mm
- 06-233 Fig.5 64 x 85 mm

**06-218 - 06-228**  
DOYEN  
240 mm

**06-229 - 06-233**  
FRITSCH  
240 mm

**06-234**  
DOYEN  
250 mm

	width of blades	
	35 mm, 45 mm, 60 mm	
length of blades		
62 mm	06-218, 06-222, 06-226	
92 mm	06-219, 06-223, 06-227	
122 mm	06-220, 06-224, 06-228	
160 mm	06-221, 06-225	

Abdominal- and Intestinal Spatulas  
Bauch- und Darmspatel



**06-235**  
LERICHE  
255 mm

**06-236**  
KUMMEL  
Mealleable  
285 mm

**06-237**  
MIKULICZ  
29 mm  
250 mm

**06-238 - 06-239**  
KADER  
**06-238** 30 mm  
**06-239** 40 mm  
270 mm

## Self-Retaining Retractors

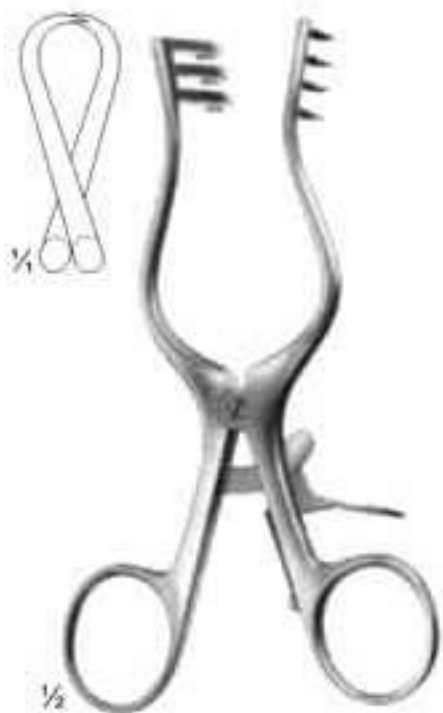

**06-240**  
WEITLANER  
sharp  
130 mm

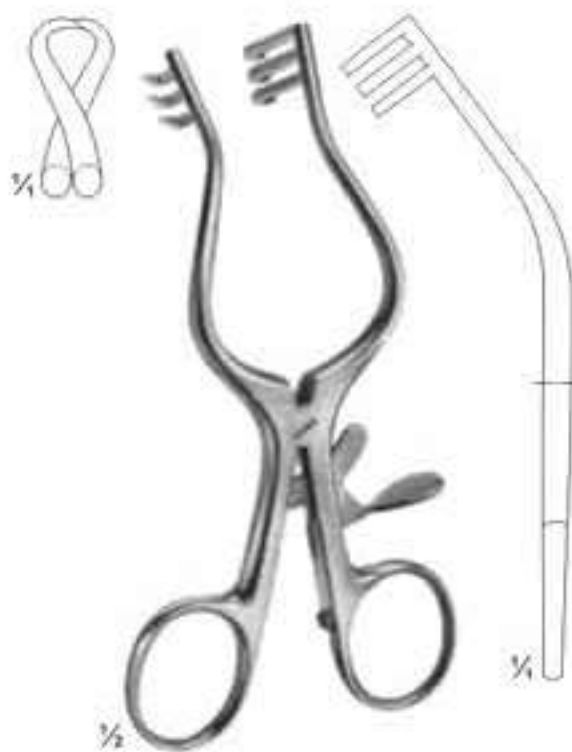

**06-241**  
WULLSTEIN  
sharp  
130 mm

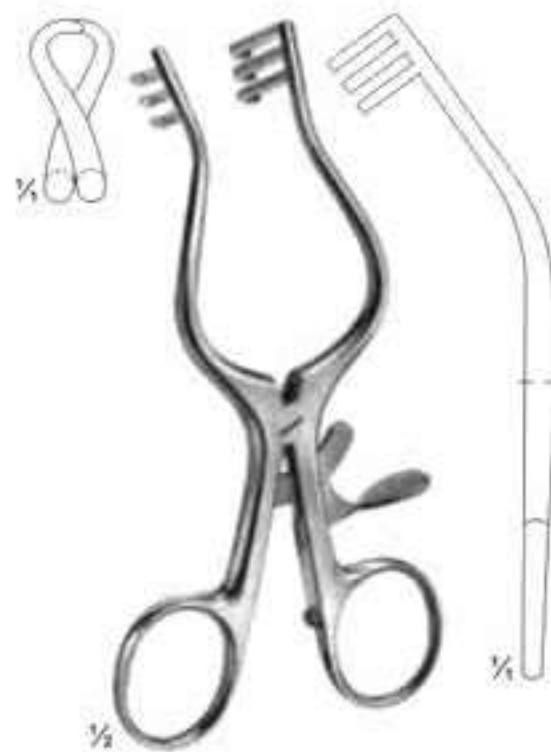

**06-242**  
WULLSTEIN  
blunt  
130 mm



**06-243**  
WEITLANER  
sharp  
165 mm



**06-244**  
PLESTER  
blunt  
110 mm



**06-245**  
PERKINS  
blunt  
130 mm

## Special Retractors



1/2

**06-246**  
JOLL ( FRIEDMAN )  
Thyroid- and vaginal retractor  
155 mm



1/2

**06-247**  
JACKSON BURROWS  
Retractor, blunt  
185 mm



1/2

**06-248**  
GELPI  
Vaginal retractor  
135 mm

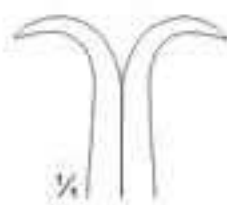

1/2

**06-249**  
GELPI  
Skin- and vaginal retractor  
175 mm

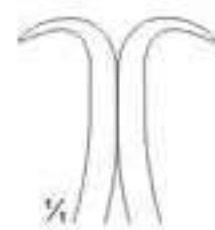

1/2

**06-250**  
DE BAKEY  
Femur retractor  
145 mm

# Lamina Spreaders



**06-251**  
CLOWARD  
155 mm



**06-252**  
CLOWARD  
135 mm



**06-253**  
INGE  
170 mm

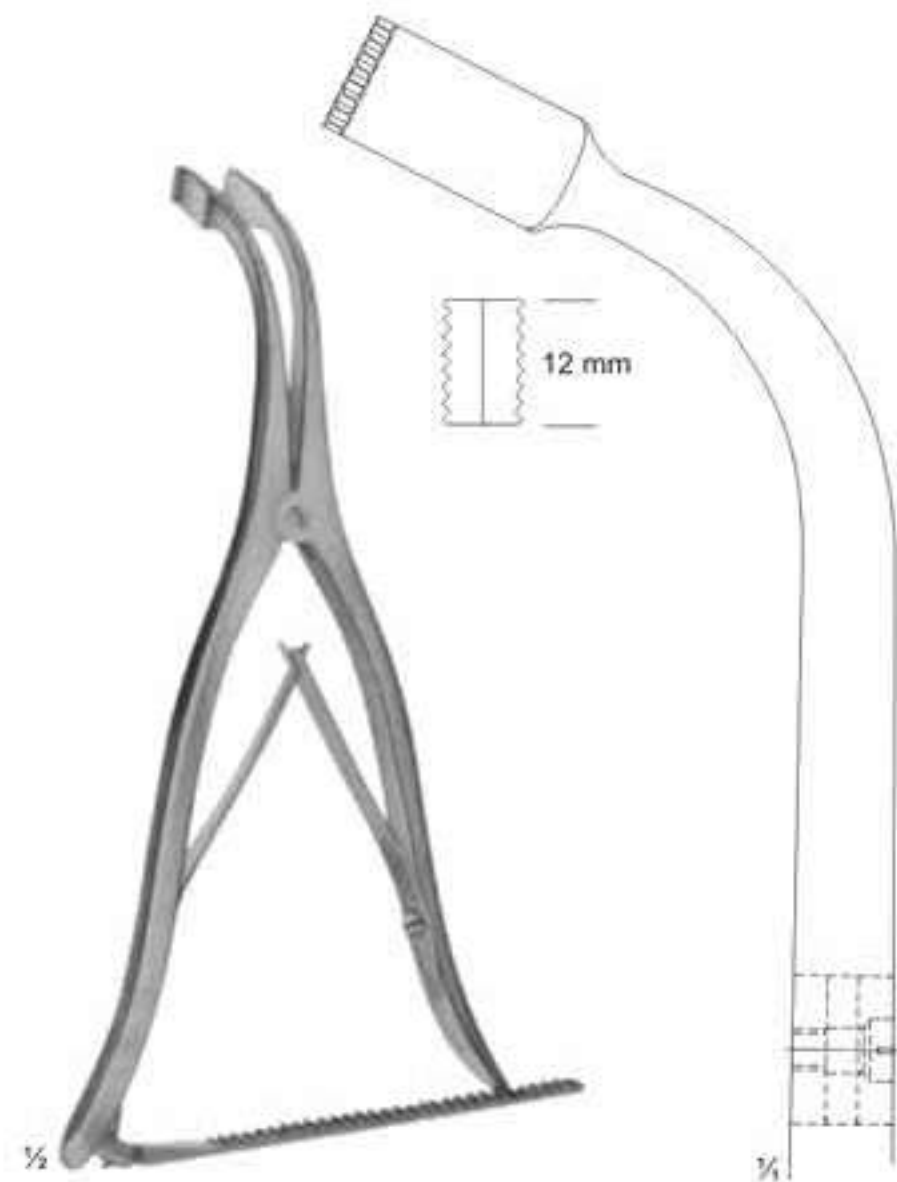

**06-254**  
INGE  
275 mm

## Abdominal Retractors



**06-255**  
GOSSET  
Blades: 38 mm deep

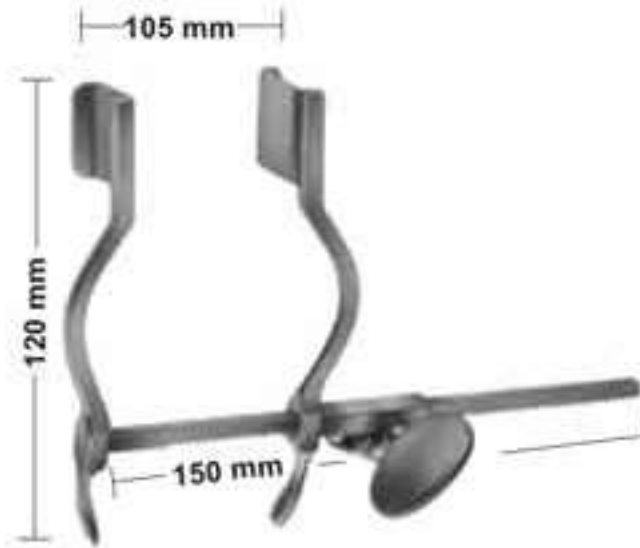

**06-256**  
HERTZLER  
Blades 20 X 25 mm

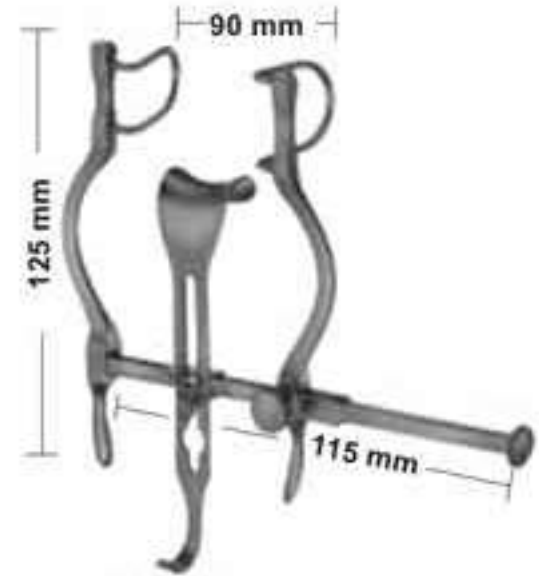

**06-257**  
BALFOUR-BABY  
Lateral blades 27 mm deep  
Center blade 21x24 mm

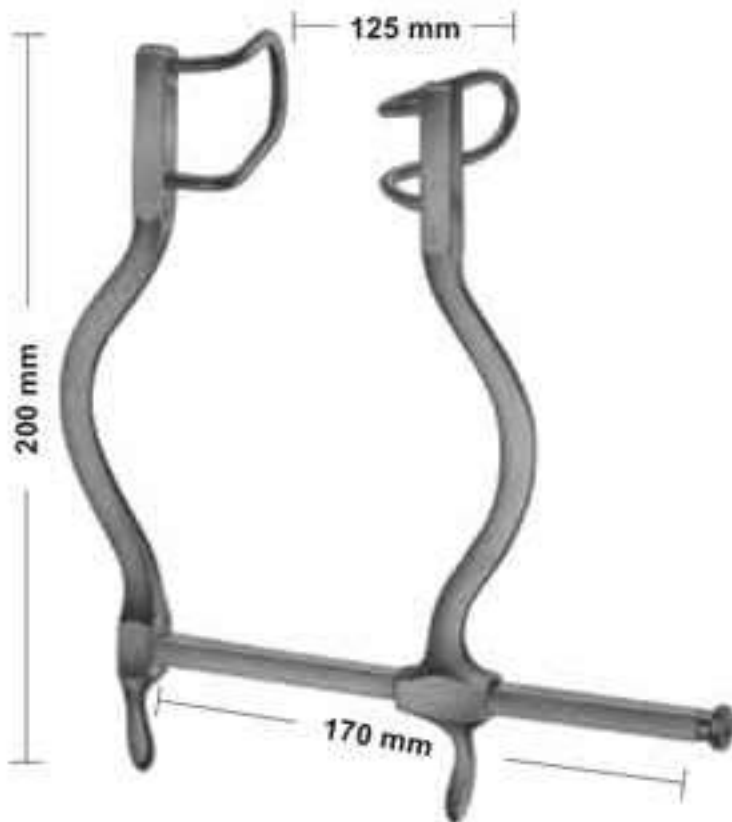

**06-258**  
GOSSET  
Blades: 55 mm deep

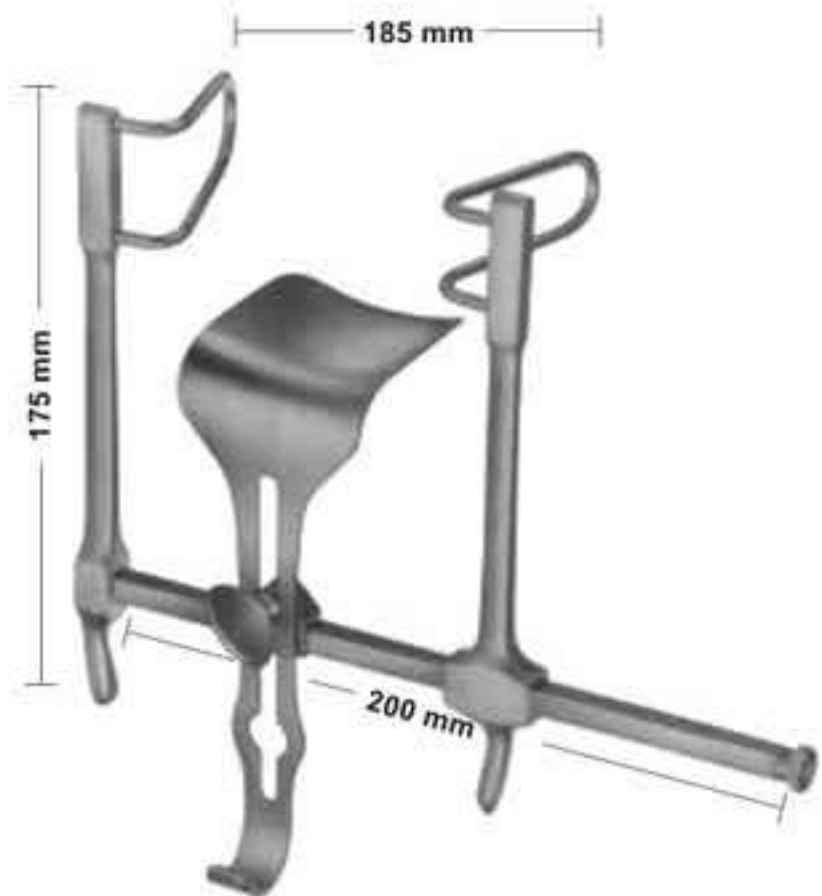

**06-259**  
GOSSET  
Lateral blades 58 mm deep  
Center blade 59 x 57 mm

# Abdominal Retractors

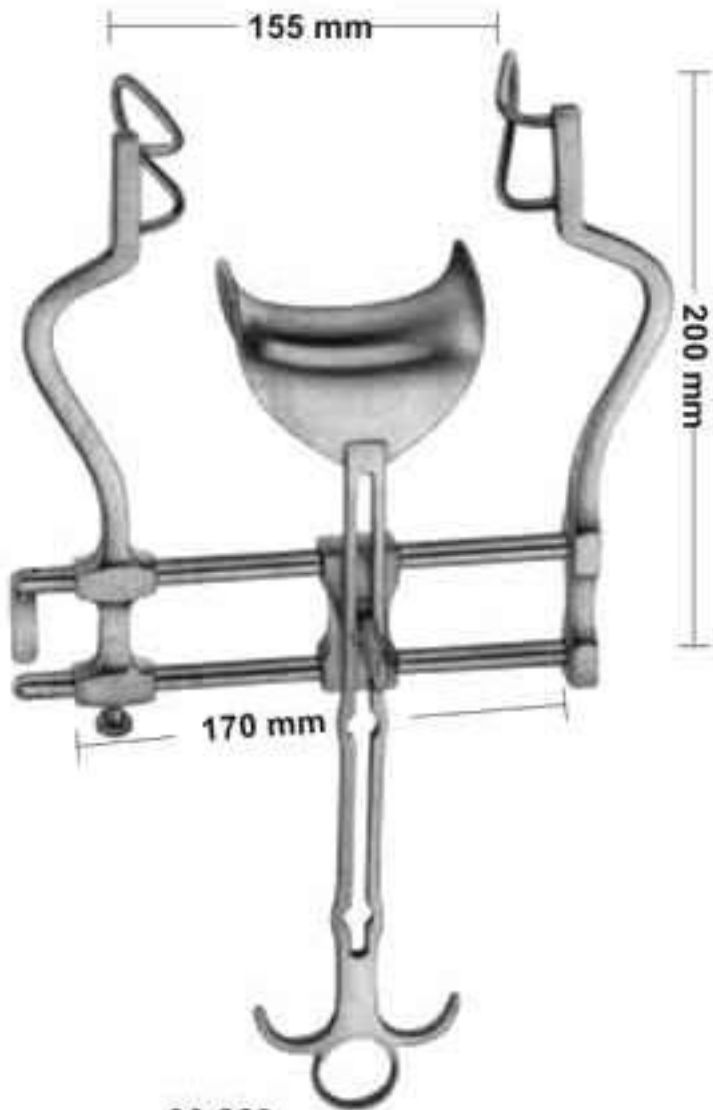

**06-260**  
BALFOUR  
Lateral blades 60 mm deep  
Center blade 47 x 80 mm

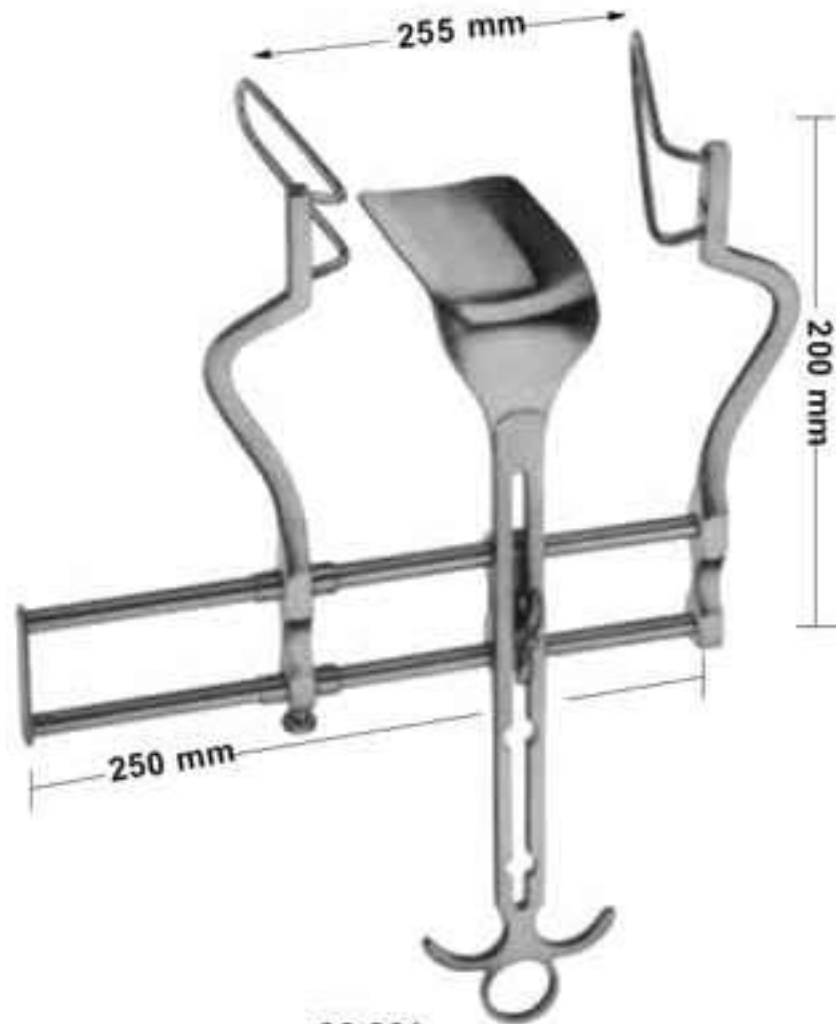

**06-261**  
BALFOUR  
Lateral blades 105 mm deep  
Center blade 107x 59 mm



**06-262**  
Center blade only  
54x80 mm

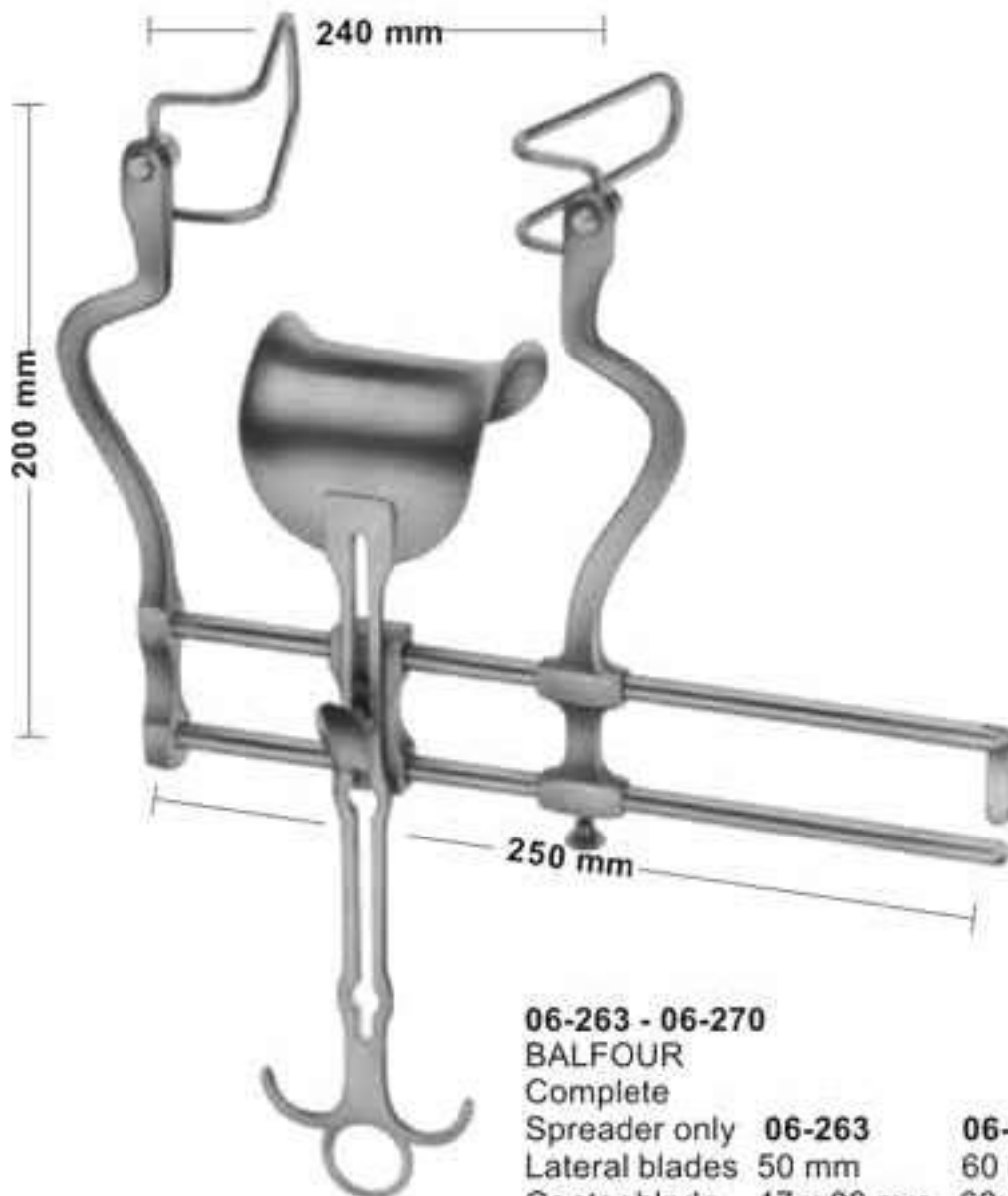

**06-263 - 06-270**  
BALFOUR  
Complete

Spreader only	<b>06-263</b>	<b>06-264</b>	<b>06-265</b>	<b>06-266</b>
Lateral blades	50 mm	60 mm	75 mm	90 mm
Center blade	47 x 80 mm	62x76 mm	80x80 mm	80x80 mm



Sales Unit of blades: PR = pair

- Lateral blades
- 06-267** 50 mm deep
- 06-268** 60 mm deep
- 06-269** 75 mm deep
- 06-270** 90 mm deep



# Organ-, Tissue and Intestinal Grasping Forceps

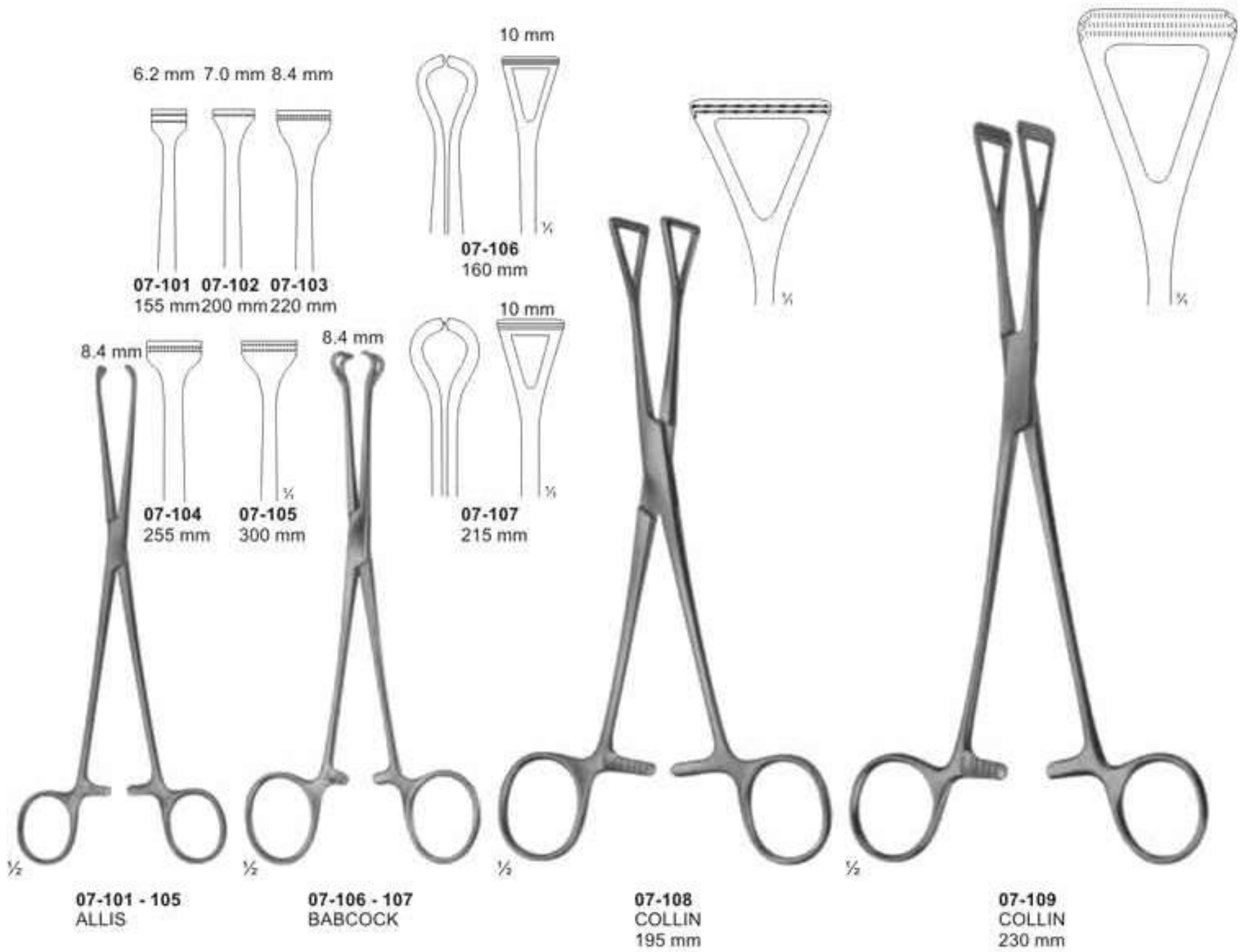

Intestinal Clamps, soft elastic

ATRAUMATA

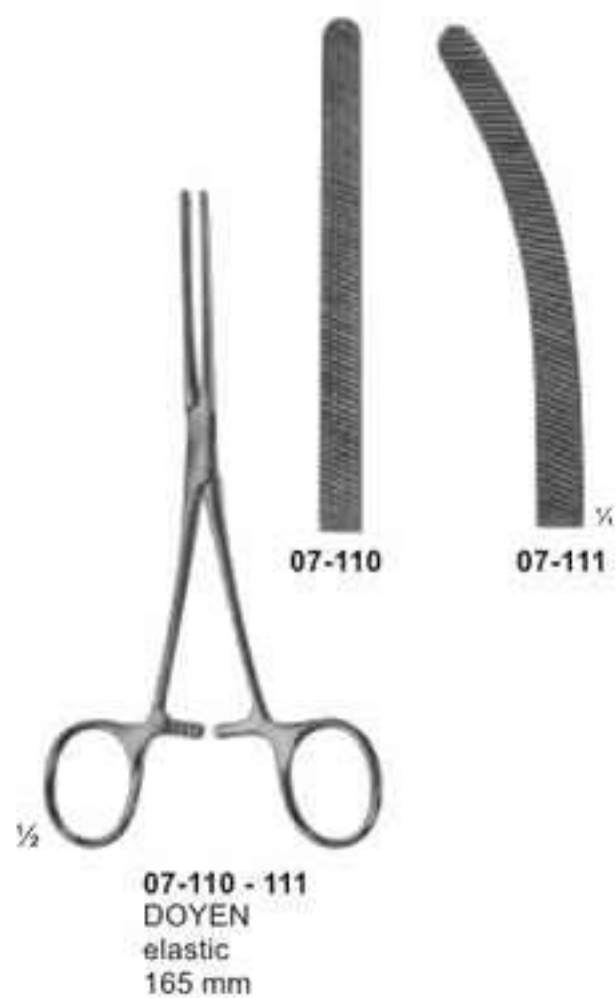

ATRAUMATA

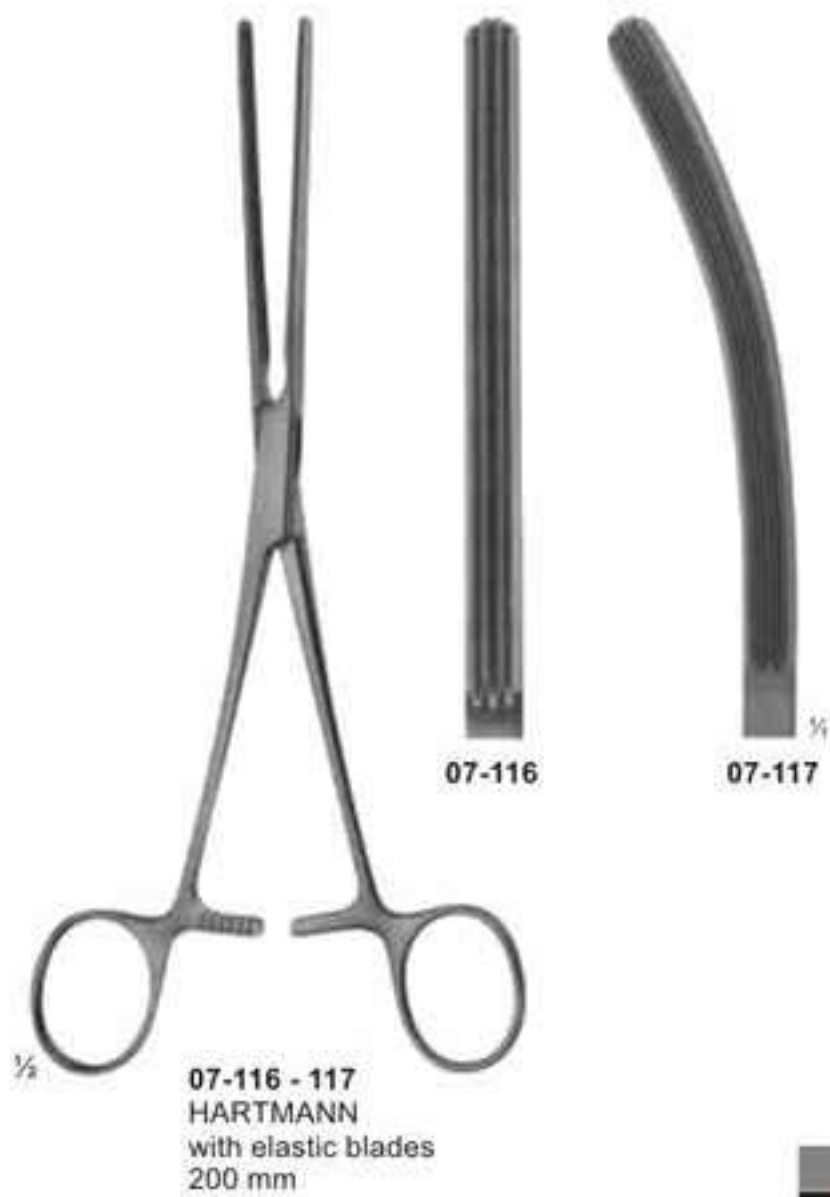
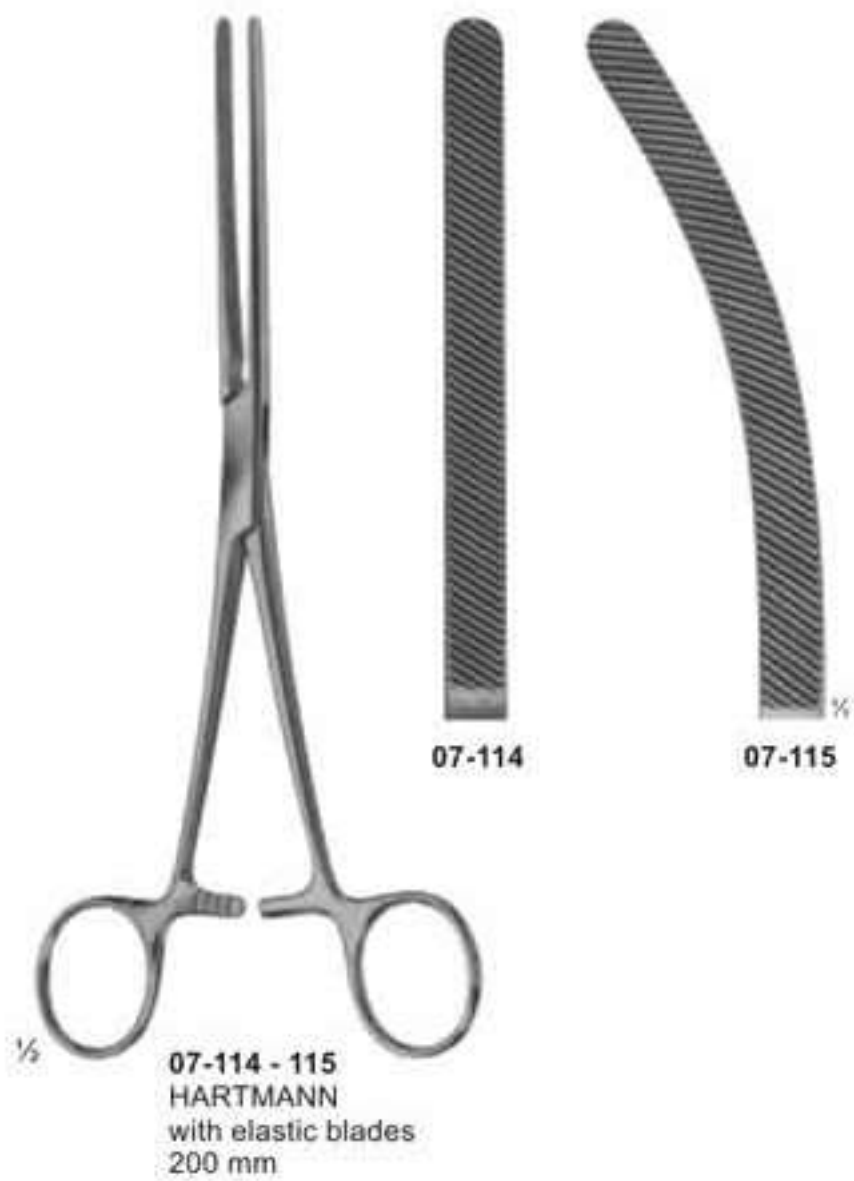

## Intestinal and Pylorus Clamps



**07-118**  
PAYR  
Intestinal clamp  
light pattern,  
for children  
180 mm

**07-119**  
PAYR  
200 mm

**07-120**  
PAYR  
275 mm

**07-121**  
PAYR  
Pylorus clamp  
315 mm

**ATRAUMATA**  
**Sigmoid Anastomosis Forceps**

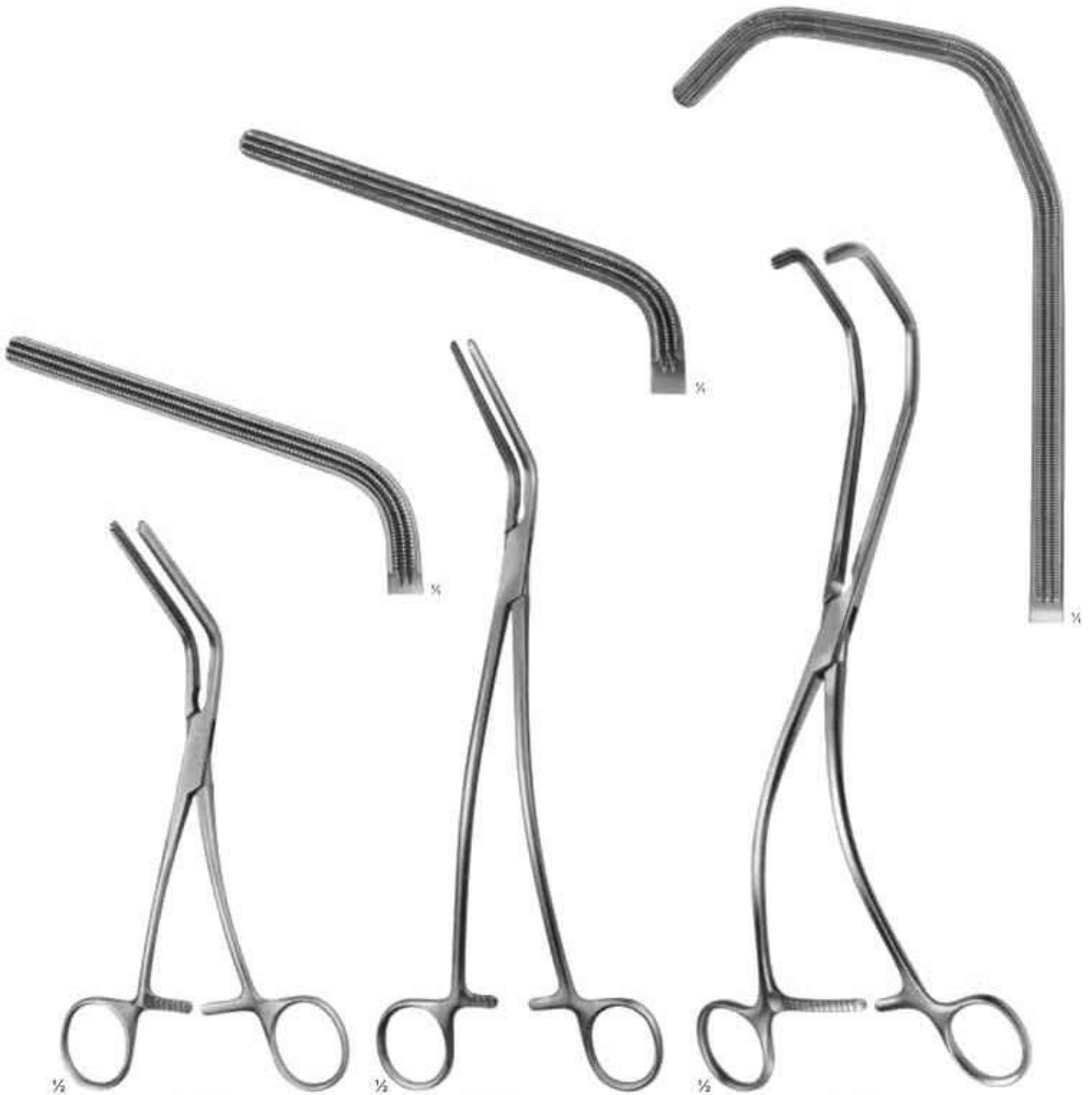

**07-122**  
**MORRIS**  
175 mm

**07-123**  
**DE BAKEY**  
(MORRIS modif.)  
240 mm

**07-124**  
**KERSTING**  
270 mm

# Nasal Specula

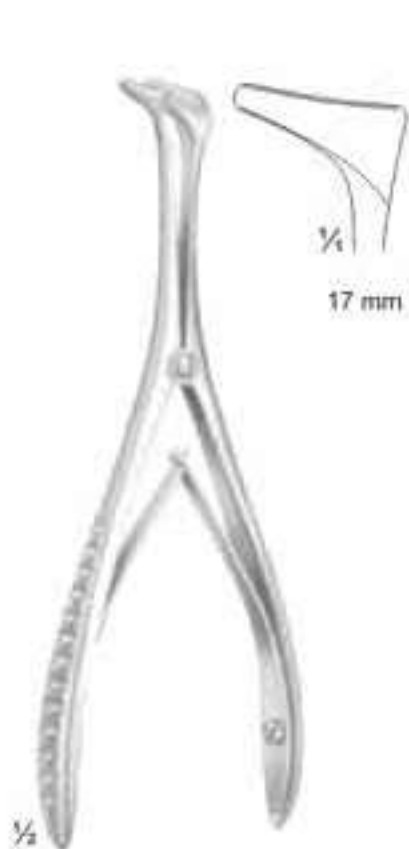

**08-101**  
Martin  
13 cm / 5 1/8"



**08-102**  
SIMS  
160 mm



**08-103**  
Tieck-Halle  
13 cm / 5 1/8"



**08-104**  
Killian

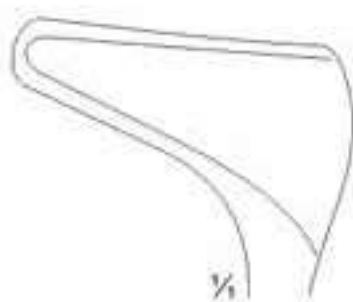

Fig. 1  
14 cm 5 4/8"  
35 mm

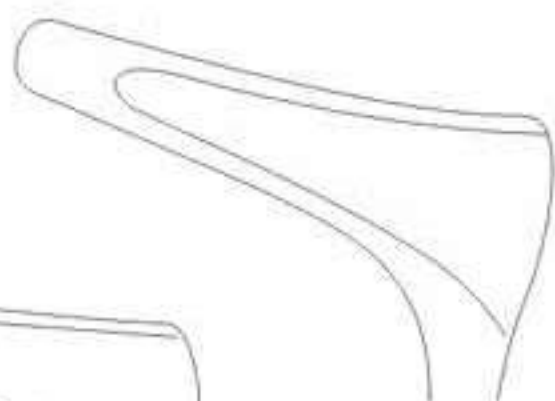

Fig. 2  
14,5 cm / 5 4/8"  
50 mm

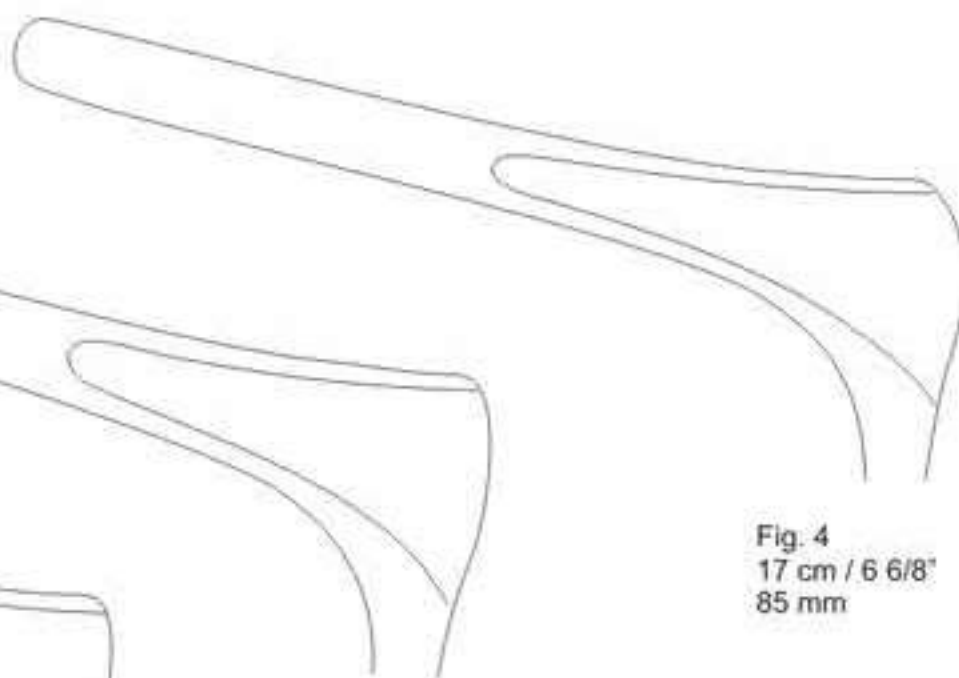

Fig. 3  
16 cm / 6 2/8"  
75 mm

Fig. 4  
17 cm / 6 6/8"  
85 mm

# Nasal Specula



**08-105**  
Cottle

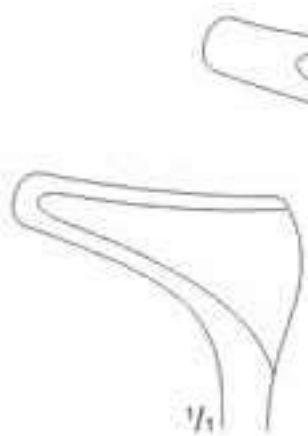

Fig. 1  
13,5 cm / 5 3/8"  
35 mm

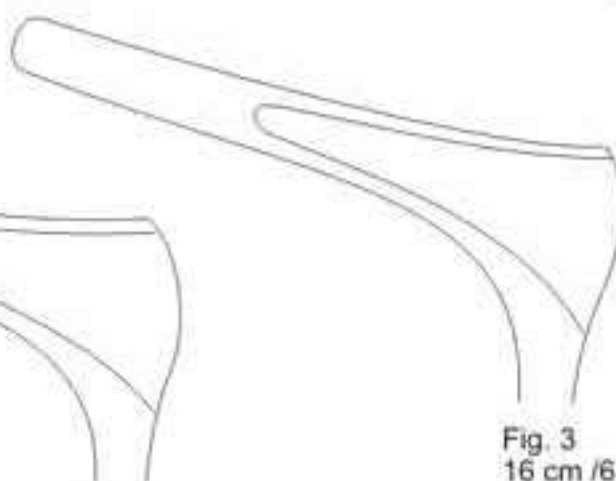

Fig. 2  
14 cm / 5 4/8"  
50 mm

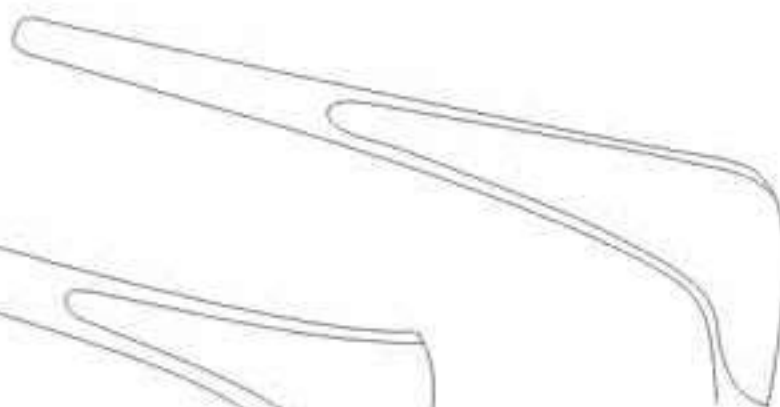

Fig. 3  
16 cm / 6 2/8"  
75 mm

Fig. 4  
16 cm / 6 2/8"  
85 mm



**08-106**  
Goldsmith (Thudichum)  
6,5 cm / 2 4/8"



Fig. 1  
21,0 x 9,5 mm



Fig. 2  
21,0 x 10,5 mm



Fig. 3  
21,0 x 11,5 mm



**08-107**  
Mod. Wien 2  
13,5 cm / 5 1/8"



Fig. 1  
30 mm



**08-108**  
Hartmann-Halle  
16 cm / 6 1/4"



Fig. 1  
27 mm



Fig. 2  
31 mm

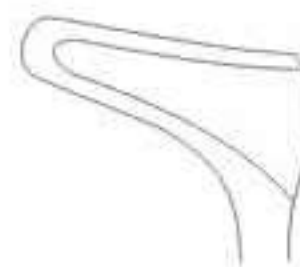

Fig. 3  
35 mm

## Anuscopes-Sphincteroscopes



**08-109**  
IVES-FANSLER  
Anuscops  
145 mm  
Ø24mm



**08-110**  
KELLY  
Sphincteroscope  
160 mm  
Ø21mm



**08-111**  
KELLY  
Sphincteroscope  
160 mm  
Ø27mm

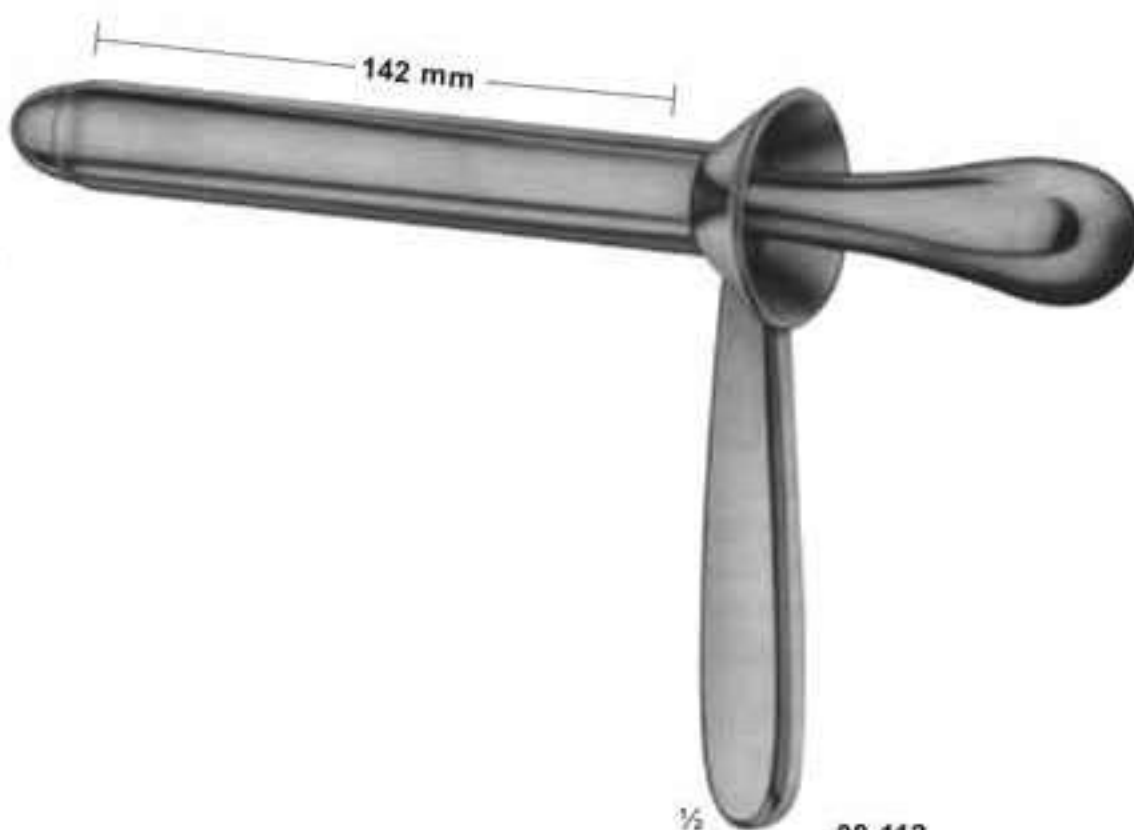

**08-112**  
KELLY  
Proctoscope  
140 mm  
Ø22mm

# Haemorrhoidal Forceps

## ATRAUMATA

## Pressure Clamp

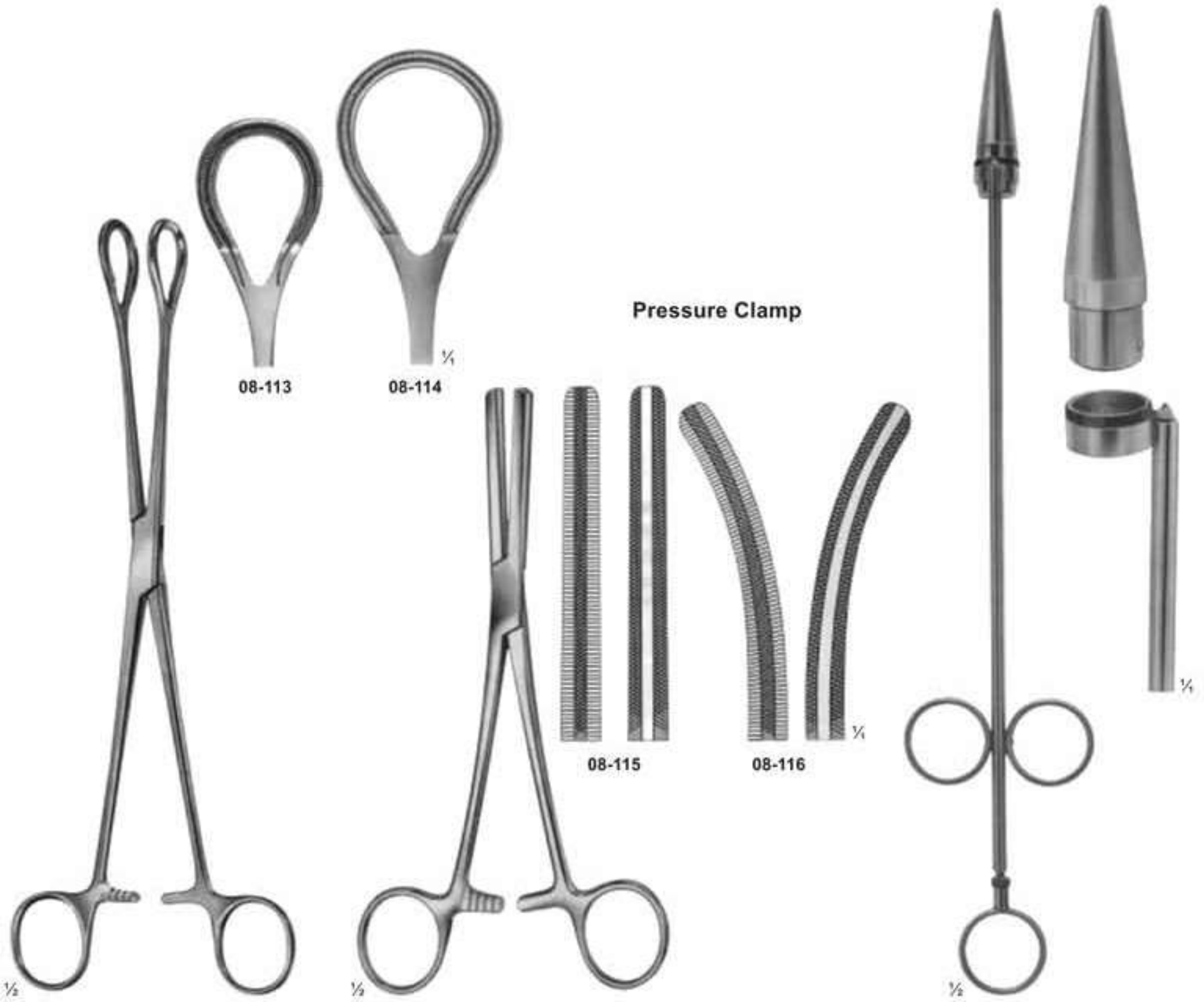

08-113 - 08-114  
250 mm  
270 mm

08-115 - 08-116  
FERGUSSON  
200 mm

08-117  
RUDD  
Haemorrhoidal ligator  
with loading  
attachment and 100  
ligature rubber rings  
315 mm



## Gall Duct Forceps



**08-118**  
LOWER  
180 mm



**08-119**  
LAHEY ( SWEET )  
190 mm



**08-120**  
LAHEY  
220 mm



**08-121**  
DESJARDINS  
Gall duct-and cystic forceps  
210 mm



**08-122**  
NISSEN  
Gall duct-and cystic forceps  
215 mm

## Gall Duct Dilators and Gall Stone Scoops

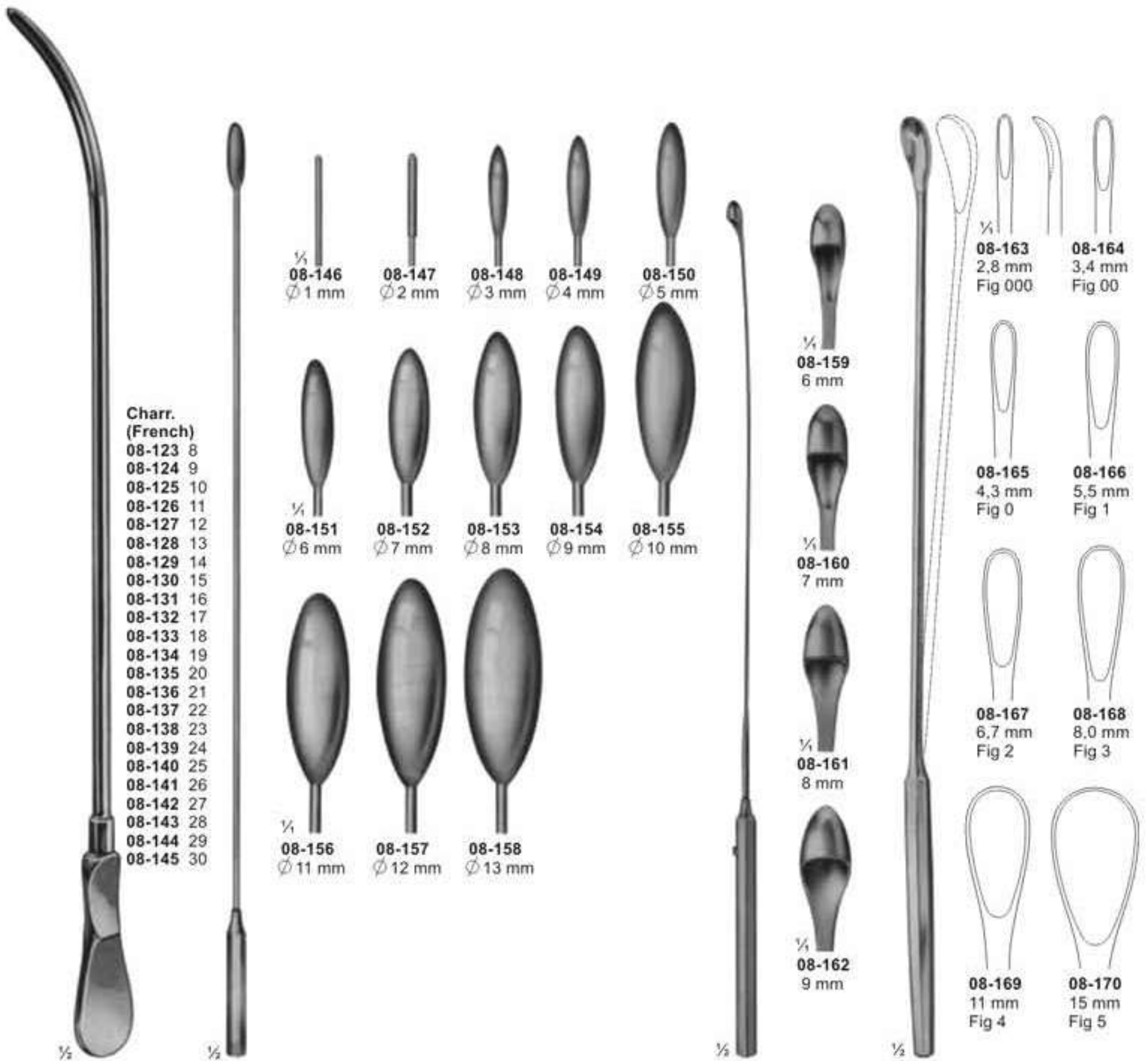

Charr.  
(French)  
08-123 8  
08-124 9  
08-125 10  
08-126 11  
08-127 12  
08-128 13  
08-129 14  
08-130 15  
08-131 16  
08-132 17  
08-133 18  
08-134 19  
08-135 20  
08-136 21  
08-137 22  
08-138 23  
08-139 24  
08-140 25  
08-141 26  
08-142 27  
08-143 28  
08-144 29  
08-145 30

1/2  
08-146  
Ø 1 mm

08-147  
Ø 2 mm

08-148  
Ø 3 mm

08-149  
Ø 4 mm

08-150  
Ø 5 mm

1/2  
08-151  
Ø 6 mm

08-152  
Ø 7 mm

08-153  
Ø 8 mm

08-154  
Ø 9 mm

08-155  
Ø 10 mm

1/2  
08-156  
Ø 11 mm

08-157  
Ø 12 mm

08-158  
Ø 13 mm

1/2  
08-159  
6 mm

08-160  
7 mm

1/2  
08-161  
8 mm

08-162  
9 mm

1/2  
08-163  
2.8 mm  
Fig 000

08-164  
3.4 mm  
Fig 00

08-165  
4.3 mm  
Fig 0

08-166  
5.5 mm  
Fig 1

08-167  
6.7 mm  
Fig 2

08-168  
8.0 mm  
Fig 3

08-169  
11 mm  
Fig 4

08-170  
15 mm  
Fig 5

08-123 - 08-145  
DITTEL  
Metall bougies and  
dilating sounds, stiff  
345 mm

08-146 - 08-158  
BAKES  
Common bile duct  
dilators, malleable  
08-146 - 08-150 315 mm  
08-151 - 08-158 320 mm

08-159 - 08-162  
DESJARDINS  
Probe and catch  
with flexible shaft  
300 mm

08-163 - 08-170  
LUER-KOERTE modif  
with malleable shaft  
310 mm

# Gall Stone Forceps

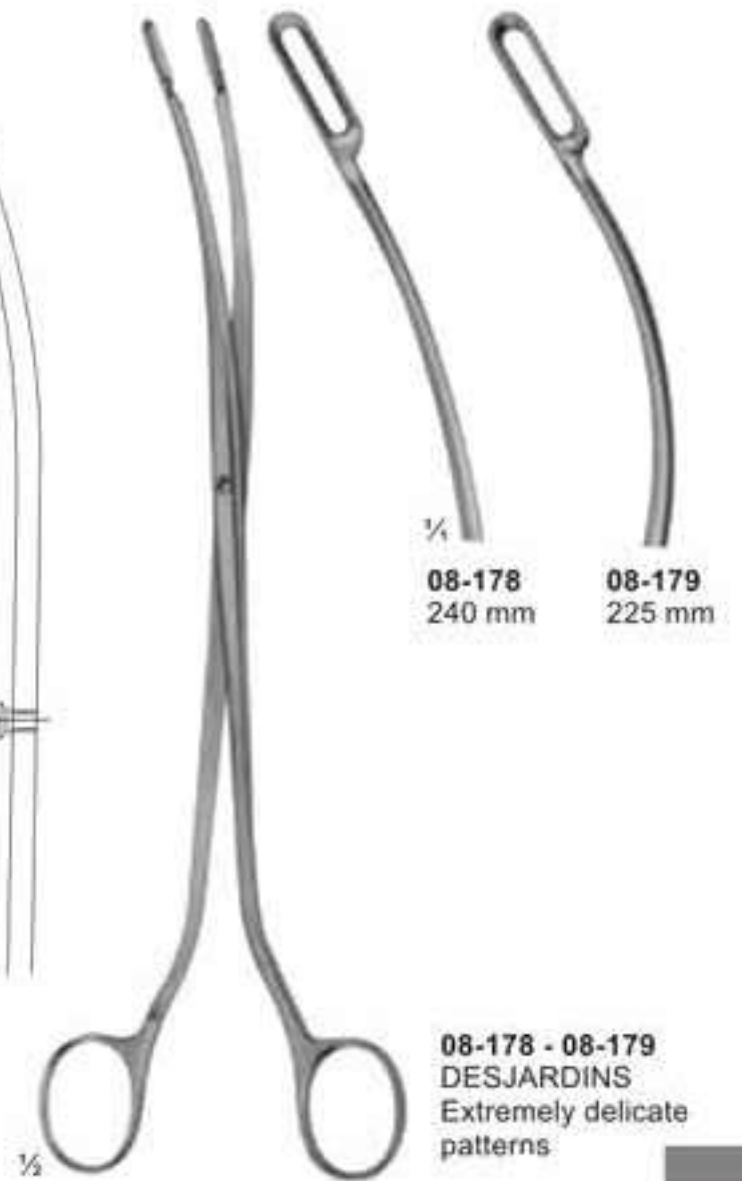
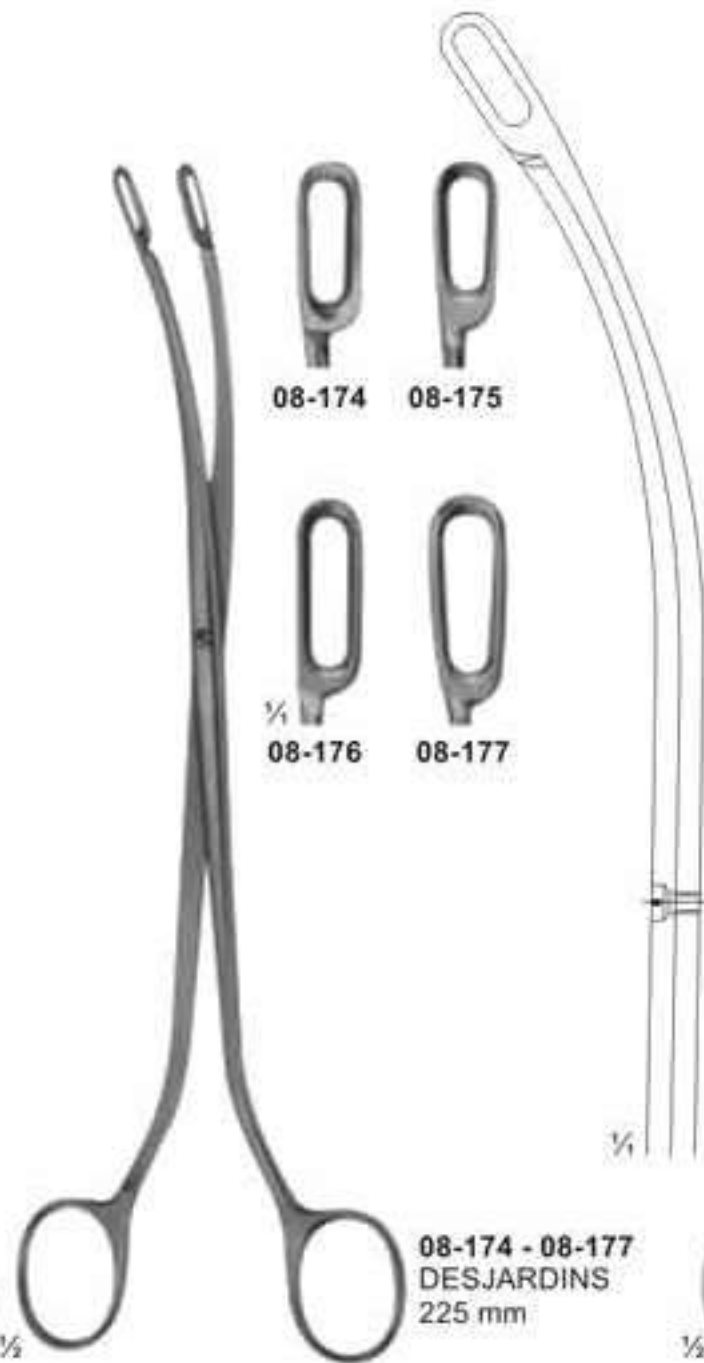
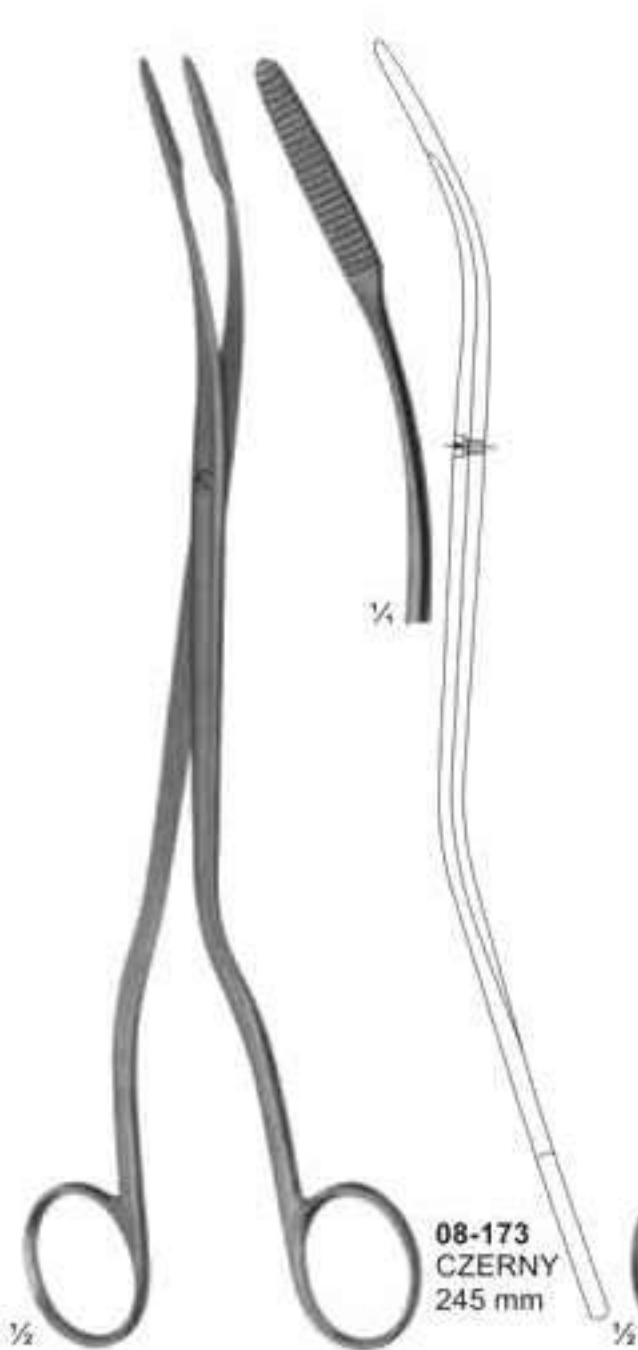

# Kidney Clamps

## ATRAUMATA

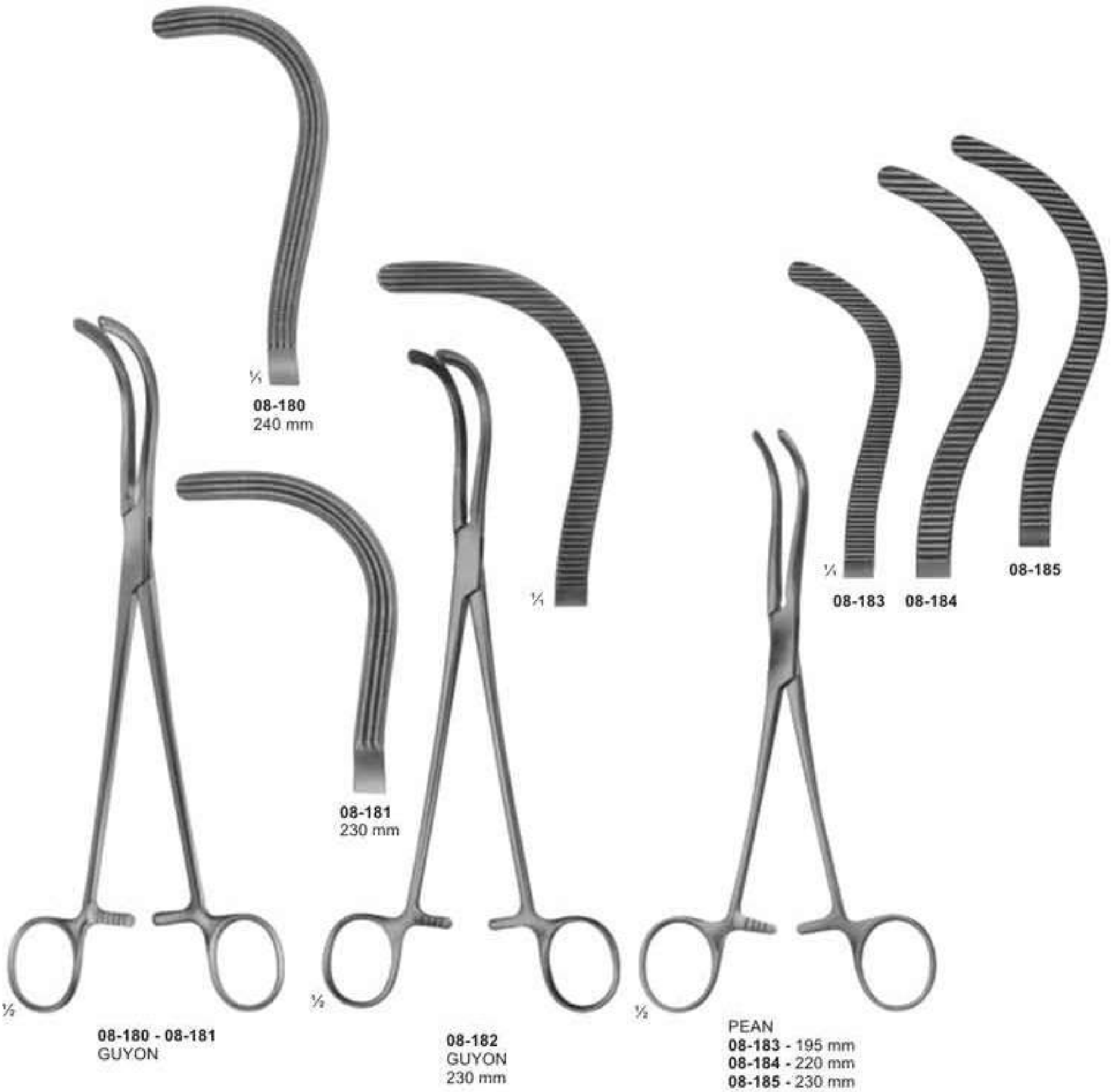

# Kidney Stone Forceps



08-186



08-187



08-188



$\frac{1}{2}$   
08-189



08-190



08-191



$\frac{1}{2}$   
08-192



$\frac{1}{2}$

08-186 - 08-189  
RANDALL  
225 mm



$\frac{1}{2}$

08-190 - 08-192  
RANDALL  
190 mm

# Bladder Retractors

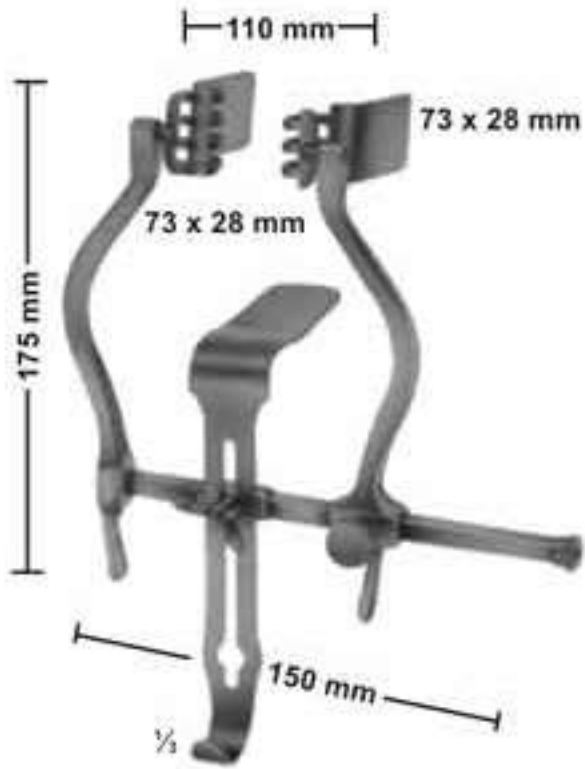

**09-101**  
JUDD-MASSON  
Bladder-and suprapubic  
retractor

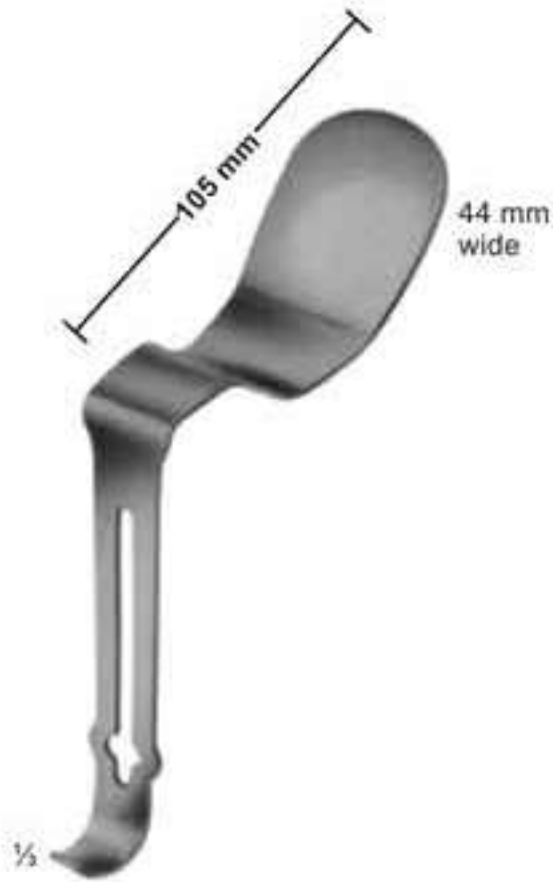

**09-102**  
MILLIN  
Center bladder for  
retro pubic prostatectomy



**09-103**  
MILLIN  
Bladder retractor, complete  
105X45 mm



**09-104**  
LEGUEU  
Bladder retractor  
Center blade  
80 x 31 mm



**09-105**  
KOCHER  
Bladder spatula  
235 mm

# Trocars



**09-106**  
KLIMA ROSEGER  
35 X 1,8 mm  
Sternal puncture needle

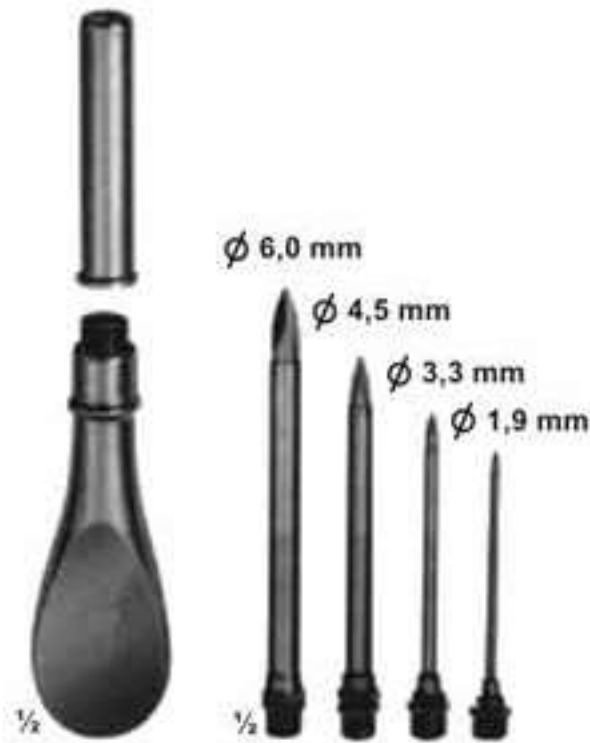

**09-107**  
Universal trocar  
with 4 tips



NELSON

**09-108 - 112**  
Inside diam. Outside diam  
09-108 2,2 mm 3,0 mm  
09-109 3,0 mm 4,0 mm  
09-110 4,0 mm 5,0 mm  
09-111 5,0 mm 6,0 mm  
09-112 5,5 mm 6,5 mm  
for hydrocele and abdominal  
puncture



**09-113 - 116**  
Inside dime. Outside dime  
09-113 2,2 mm 3,0 mm  
09-114 3,0 mm 4,0 mm  
09-115 4,0 mm 5,0 mm  
09-116 5,0 mm 6,0 mm  
for abdominal puncture,  
with stop-cock and lateral  
drain



**09-117 - 118**  
Inside diam. Outside diam  
09-117 6,5 mm 8,0 mm  
09-118 9,0 mm 10,0 mm  
Empyema trocar  
BUELEU



**09-119 - 122**  
Inside diam. Outside diam  
09-119 3,0 mm 4,0 mm  
09-120 3,6 mm 4,6 mm  
09-121 4,3 mm 5,3 mm  
09-122 5,0 mm 6,0 mm  
Gall bladder trocars. OCHSNER



**09-123**  
PIERCE  
Antrum trocar  
Ø 4,0 mm



**09-124**  
COAKLEY  
Antrum trocar  
3,0 mm

## Vaginal Specula



**10-101**  
COLLIN  
for children  
53 x 10 mm

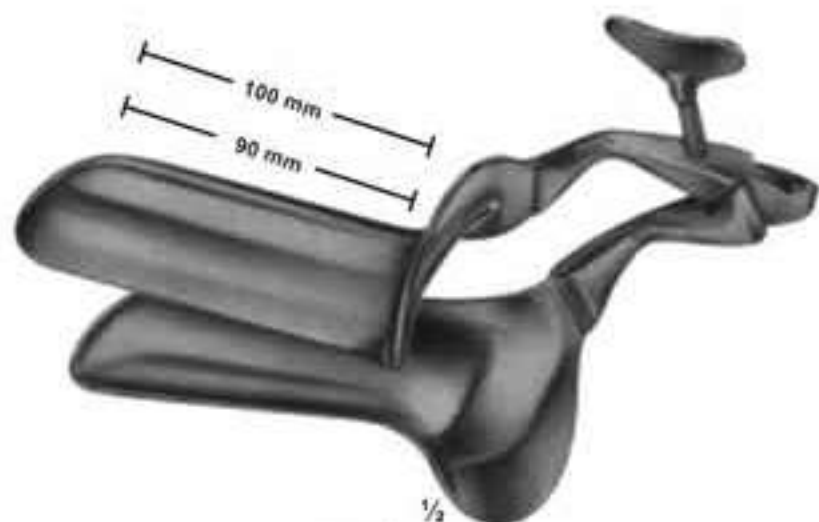

**10-102 - 105**  
COLLIN

<b>10-102</b>	100/90mm	28 mm
<b>10-103</b>	100/90mm	32 mm
<b>10-104</b>	105/95mm	35 mm
<b>10-105</b>	115/105mm	40 mm
Total length/working length		width



**10-106**  
COLLIN  
for virgins  
95/85 x 18 mm



**10-107**  
CUSCO  
for virgins  
75 x 17 mm



**10-108**  
CUSCO  
for virgins  
75 x 17 mm

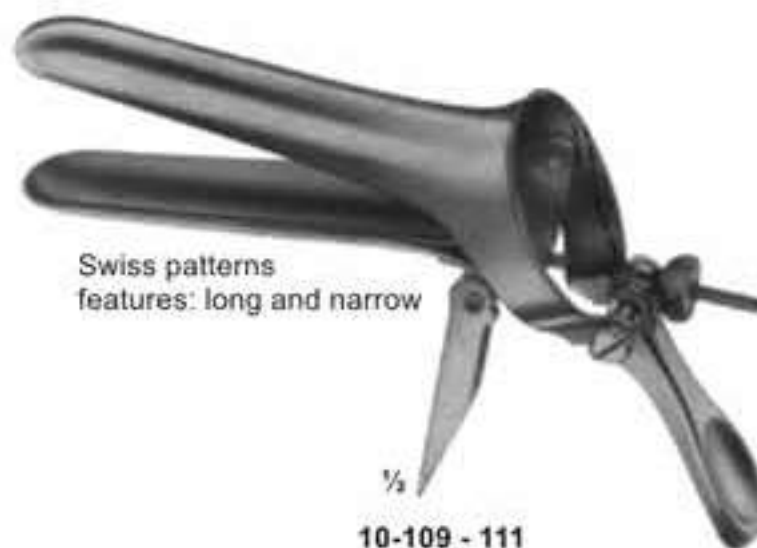

Swiss patterns  
features: long and narrow

**10-109 - 111**  
CUSCO

<b>10-109</b>	92x23-25 mm
<b>10-110</b>	100x25-27 mm
<b>10-111</b>	110x27-30 mm



Vaginal Specula- Sets, upper and lower blades



10-112 - 114  
GRAVE  
10-112 75X20 mm  
10-113 95X30 mm  
10-114 105X33 mm

1/2



10-115 - 116  
PEDERSON  
10-115 100X22 mm  
10-116 120X25 mm

1/2



10-117 - 118  
BRIESKY  
10-117 72X25 mm / 77X30 mm 140 mm  
10-118 75X30 mm / 92X38 mm 170 mm

1/2



10-119  
SIMS  
70 X 26 mm / 75 X 30 mm  
75 X 30 mm / 80 X 35 mm  
80 X 36 mm / 90 X 40 mm  
175 mm

1/2



10-120 - 122  
SEIDL  
10-120 80X8 mm  
10-121 80X10 mm  
10-122 90X14 mm  
For children and infants  
170 mm

1/2



10-123  
KRISTELLER  
70X15 mm, ( 170 mm )  
For children

1/2



10-124 - 10-126  
KRISTELLER  
10-124 70X27 mm  
10-125 75X30 mm  
10-126 90X36 mm  
175 mm

1/2

## Vaginal Specula- upper and lower blades



10-132 75X10 mm  
175 mm

10-136 70X15 mm  
175 mm

10-133 75X23 mm  
180 mm

10-137 70X27 mm  
180 mm

10-134 80X25 mm  
180 mm

10-138 75X30 mm  
180 mm

10-135 100X32 mm  
185 mm

10-139 90X36 mm  
185 mm

10-127 - 131  
KRISTELLER  
10-127 110X18 mm  
10-128 110X20 mm  
10-129 110X27 mm  
10-130 110X30 mm  
10-131 110X36 mm  
220 mm

10-132 - 10-135  
KRISTELLER  
Upper blades

10-136 - 10-139  
KRISTELLER  
Lower blades

# Vaginal Specula



10-140  
60 X 45 mm

10-141  
90 X 45 mm

10-142  
112 X 45 mm

10-140 - 142  
DOYEN  
235 mm

10-143 - 10-153  
DOYEN  
240 mm

	width of blades		
	35 mm	45 mm	60 mm
length of blades	60 mm	45 mm	60 mm
	90 mm	10-143	10-146
	120 mm	10-144	10-147
	160 mm	10-145	10-148
	10-149	10-152	10-153

## Vaginal Retractors



10-154  
JOLL (FRIEDMAN)  
155 mm



10-155  
RICHTER  
170 mm



10-156  
GELPI  
135 mm



10-157  
GELPI  
175 mm

## Uterine Dilators



**11-101 - 143**  
HEGAR  
with very conical point  
185 mm

11-101	1	mm	11-123	23	mm
11-102	2	mm	11-124	24	mm
11-103	3	mm	11-125	25	mm
11-104	4	mm	11-126	26	mm
11-105	5	mm	11-127	1	1/2mm
11-106	6	mm	11-128	2	1/2mm
11-107	7	mm	11-129	3	1/2mm
11-108	8	mm	11-130	4	1/2mm
11-109	9	mm	11-131	5	1/2mm
11-110	10	mm	11-132	6	1/2mm
11-111	11	mm	11-133	7	1/2mm
11-112	12	mm	11-134	8	1/2mm
11-113	13	mm	11-135	9	1/2mm
11-114	14	mm	11-136	10	1/2mm
11-115	15	mm	11-137	11	1/2mm
11-116	16	mm	11-138	12	1/2mm
11-117	17	mm	11-139	13	1/2mm
11-118	18	mm	11-140	14	1/2mm
11-119	19	mm	11-141	15	1/2mm
11-120	20	mm	11-142	16	1/2mm
11-121	21	mm	11-143	17	1/2mm
11-122	22	mm			



**11-144 - 152**  
HEGAR  
205 mm

11-144	1+2	mm
11-145	3+4	mm
11-146	5+6	mm
11-147	7+8	mm
11-148	9+10	mm
11-149	11+12	mm
11-150	13+14	mm
11-151	15+16	mm
11-152	17+18	mm

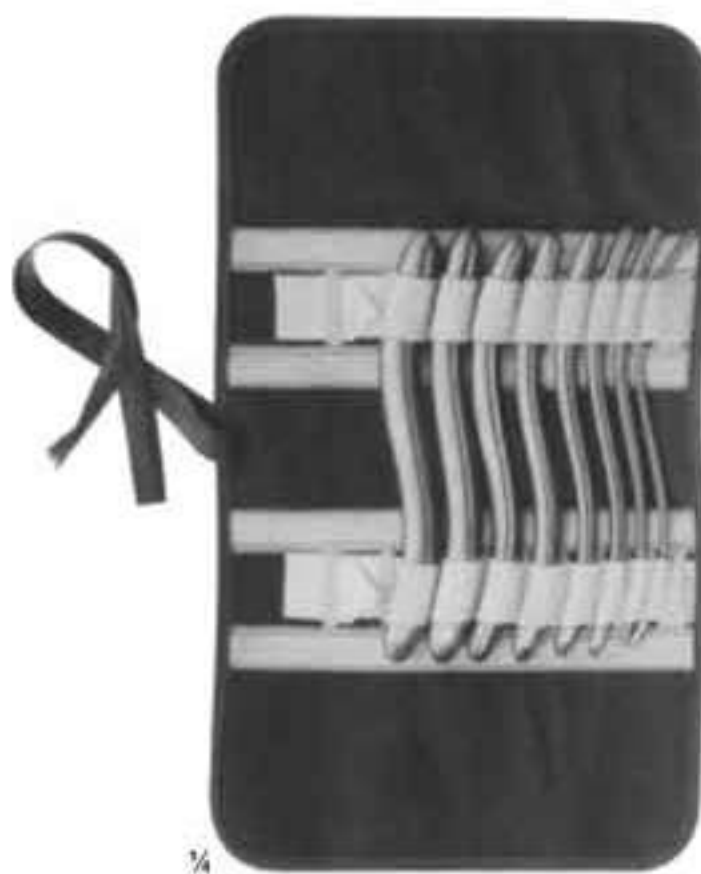

**11-153**  
HEGAR  
Uterine dilator set, in canvas  
roll with 8 dilators.

# Uterine Probes

5 mm



**11-154**  
MAYO  
malleable  
330 mm

4 mm



**11-155**  
SIMS  
malleable  
330 mm

3 mm



**11-156**  
MARTIN  
330 mm

4 mm



**11-157**  
SIMPSON  
malleable  
silver-plated  
290 mm



**11-158**  
BRAUN  
Uterine  
depressor  
270 mm

24 mm



**11-159**  
Cotton  
applicator  
270 mm

## Uterine Dressing Forceps



**11-160**  
PELMANN  
260 mm



**11-161**  
PELMANN  
260 mm



**11-162**  
BOZEMANN  
250 mm



**11-163**  
BOZEMANN  
255 mm

Jaws with longitudinal groove

## Polypus-and Ovum Forceps

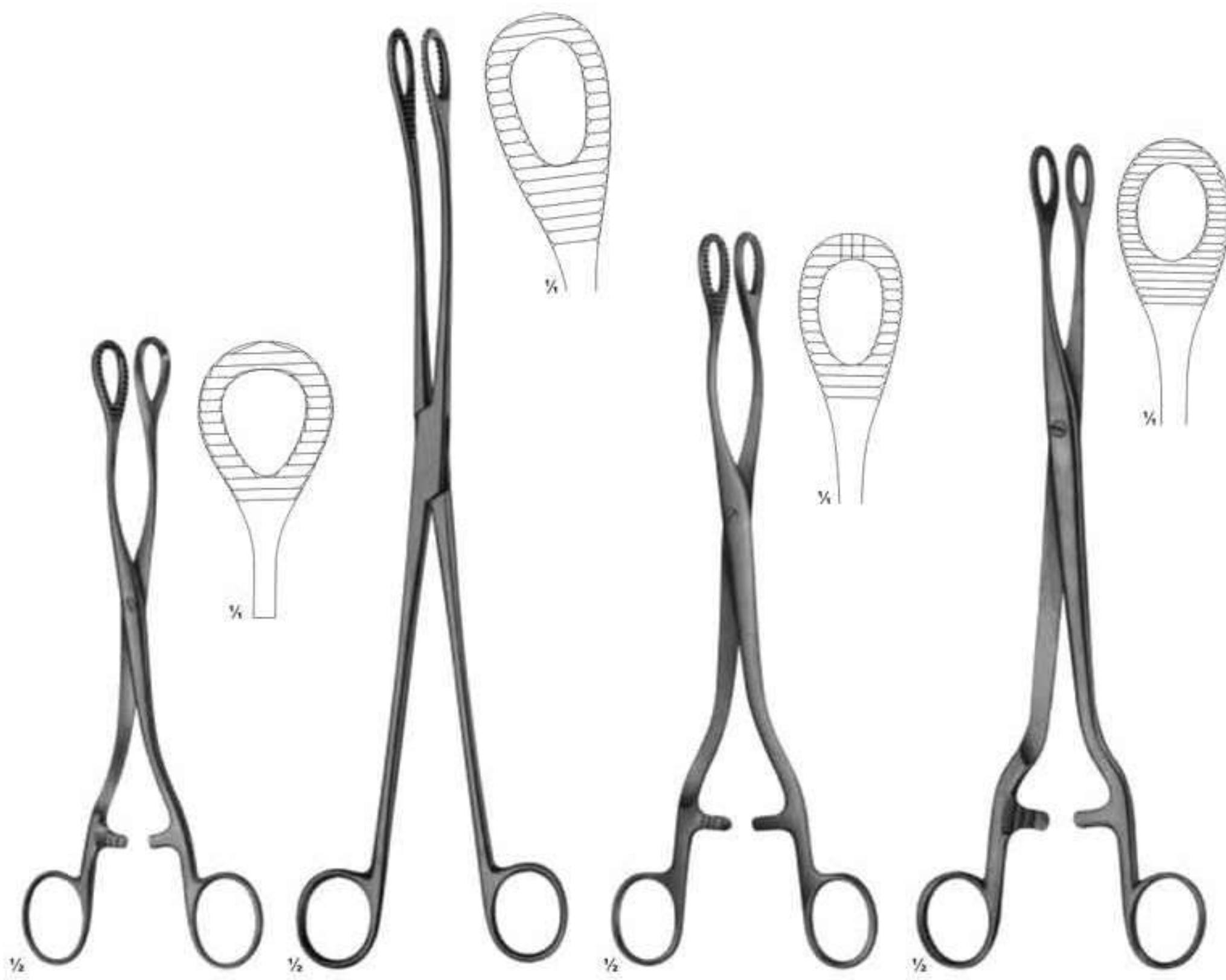

11-164  
HEYWOOD-SMITH  
200 mm

11-165  
KELLY  
320 mm

11-166  
HEYWOOD-SMITH  
250 mm

11-167  
NOTO  
280 mm



# Ear Currettes



**12-101**  
Langenbeck  
13 cm / 5 1/8"

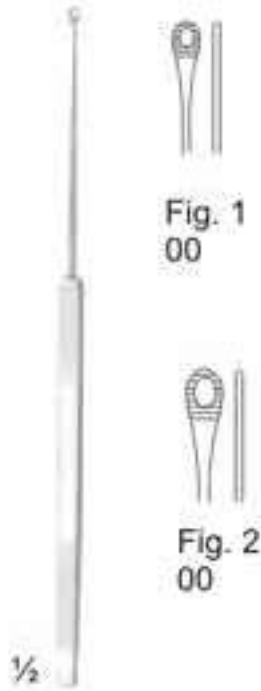

**12-102**  
Shapleigh  
15 cm / 5 1/8"

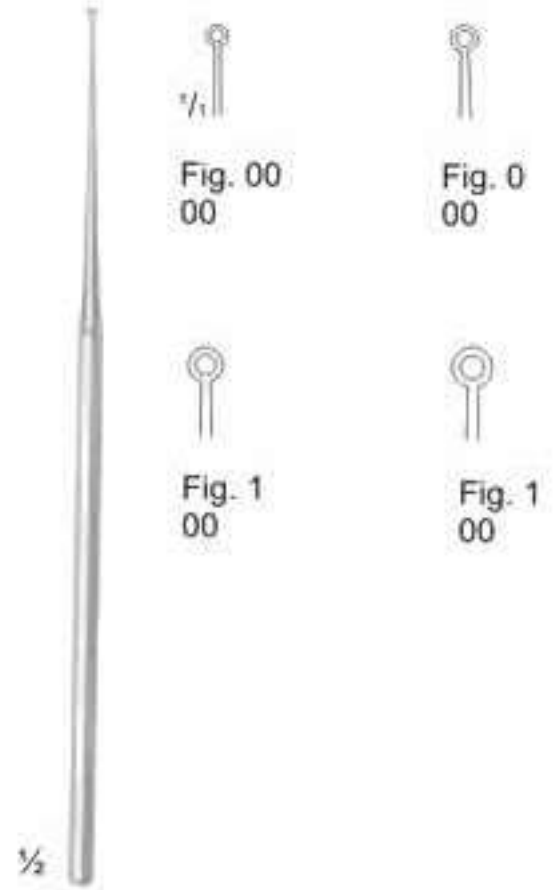

**12-103**  
Buck  
17cm / 6 6/8"



**12-104**  
Buck  
15 cm / 6 6/8"

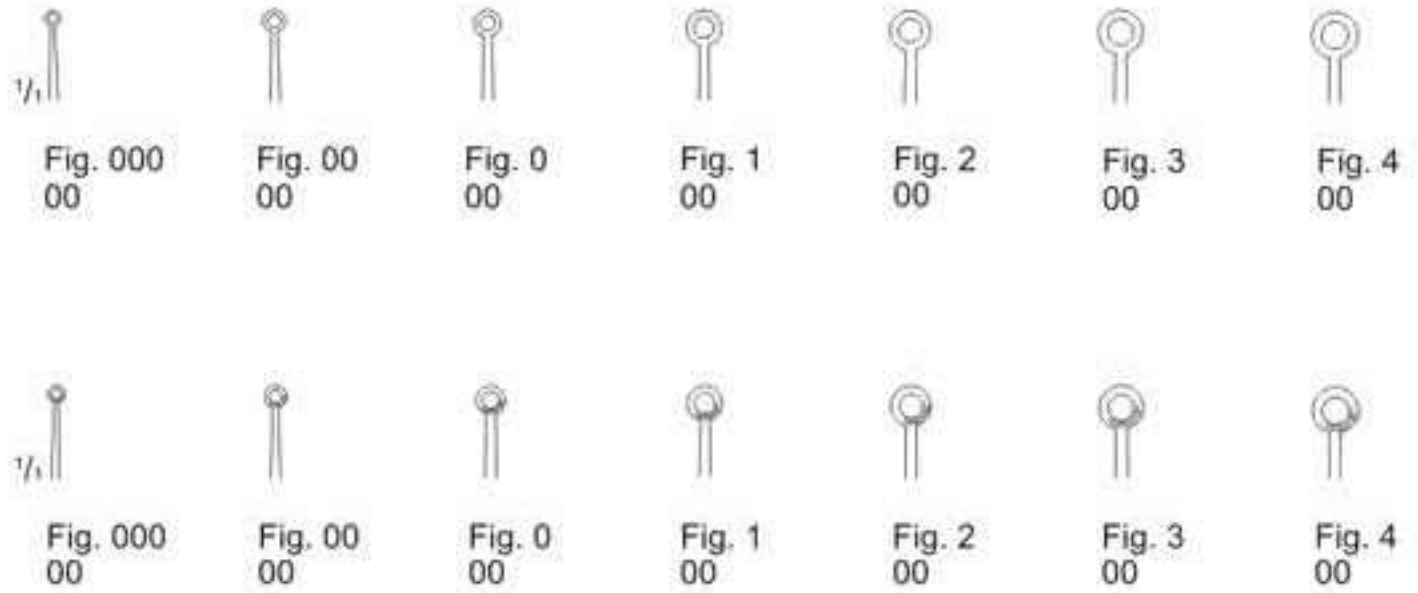

# Biopsy Curettes

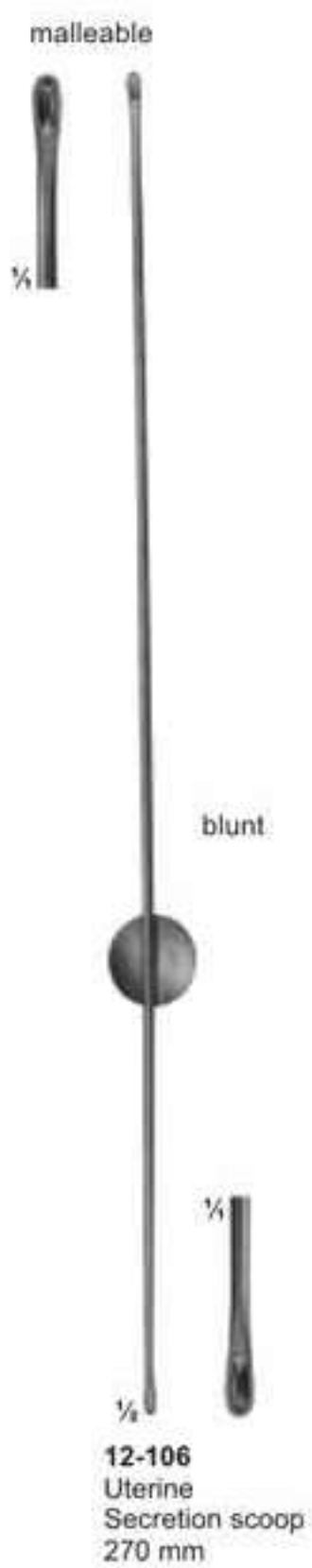
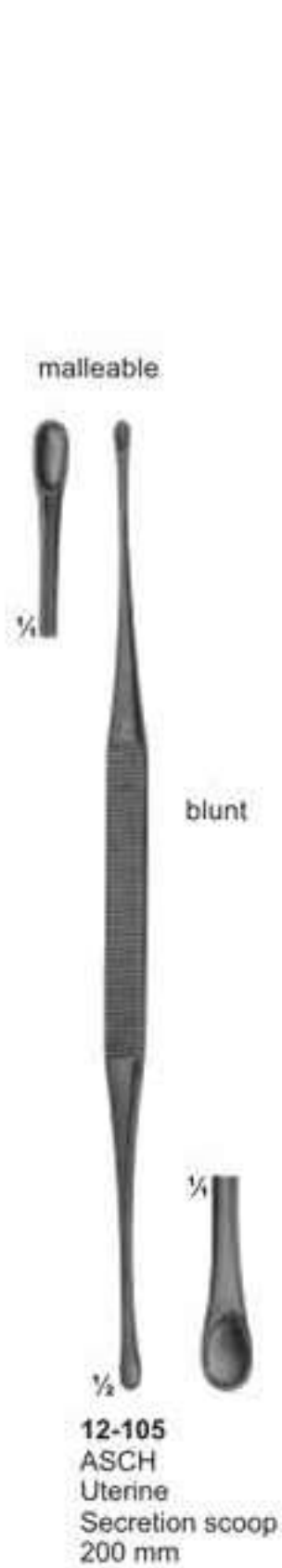

# Ear Polypus Forceps



**12-109**  
Hartmann-Wullstein  
shaft length  
85 mm



**12-110**  
Hartmann-Wullstein  
shaft length  
85 mm



**12-111**  
Hartmann  
shaft length  
85 mm



**12-112**  
Hartmann  
shaft length  
85 mm

**12-113**  
14 cm / 5 4/8"  
shaft length  
140 mm



**12-109 - 12-119**



**12-114**  
Hartmann-Herzfeil  
2,0 mm  
shaft length  
85mm



**12-115**  
Hartmann  
3 mm  
shaft length  
85mm

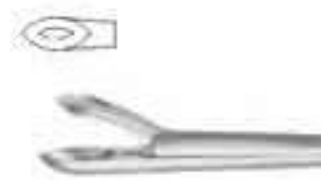

**12-116**  
shaft length  
85mm

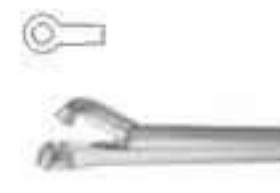

**12-117**  
Hartmann-Hoffmar  
2,0 mm  
85mm

**12-118**  
2,5 mm  
85 mm

**12-119**  
3,0 mm  
85 mm

## Biopsy forceps for rectum

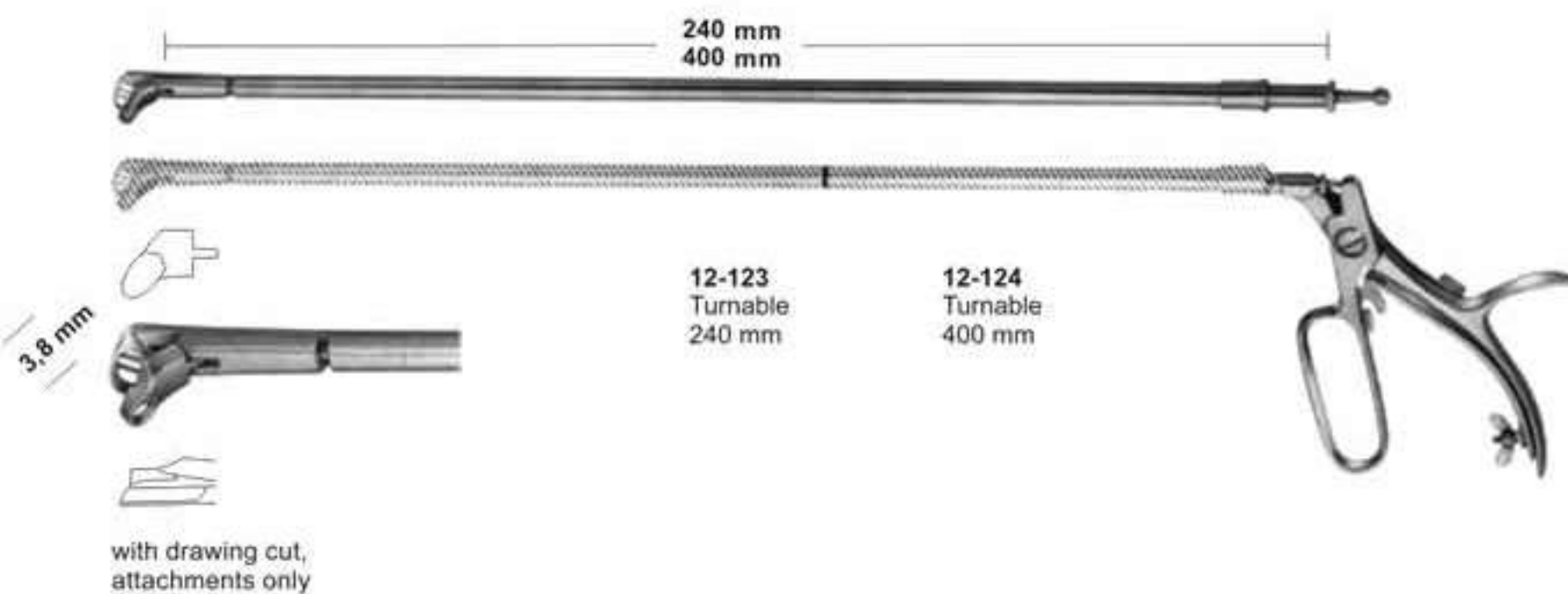
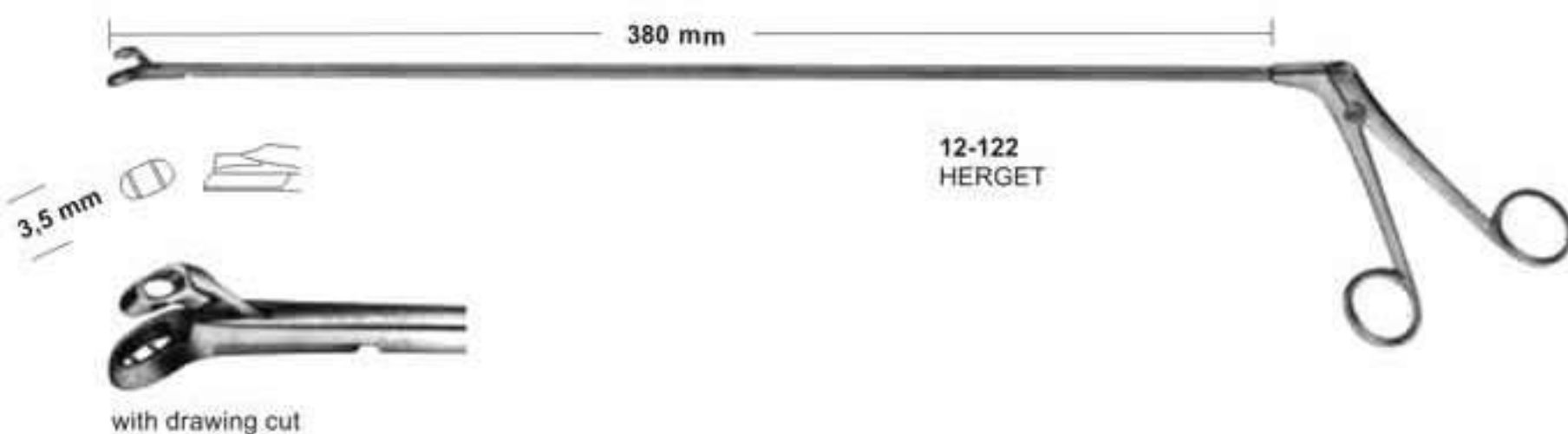
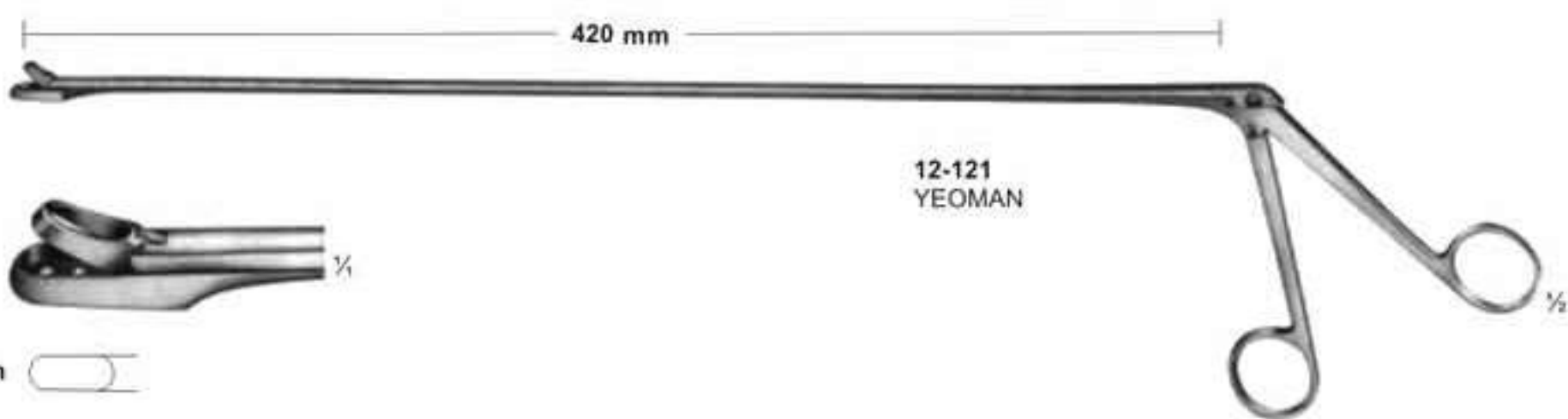
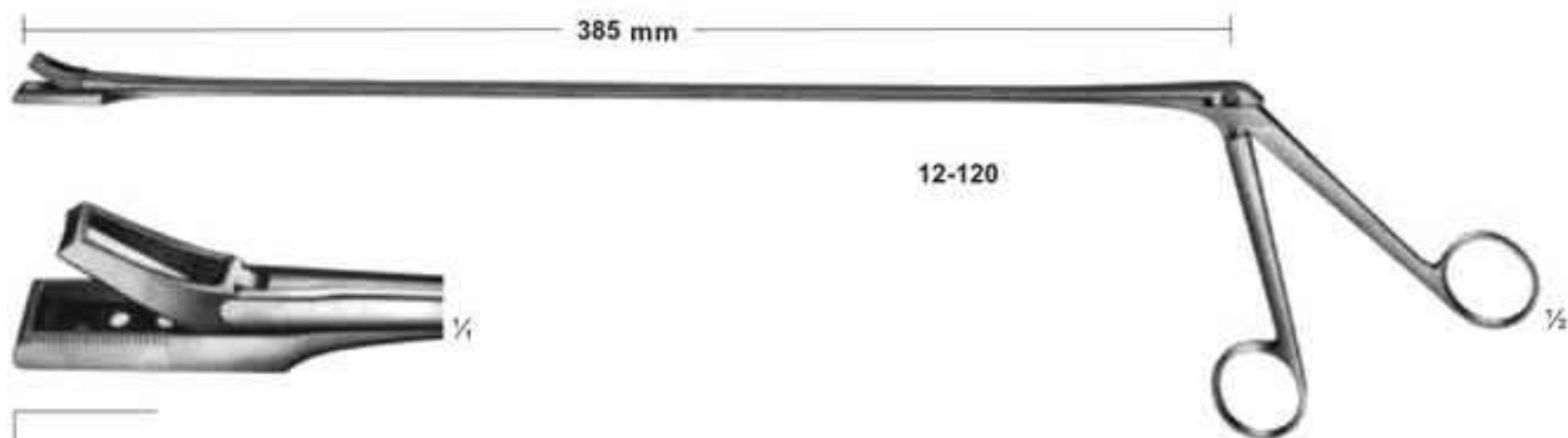

# Biopsy Forceps

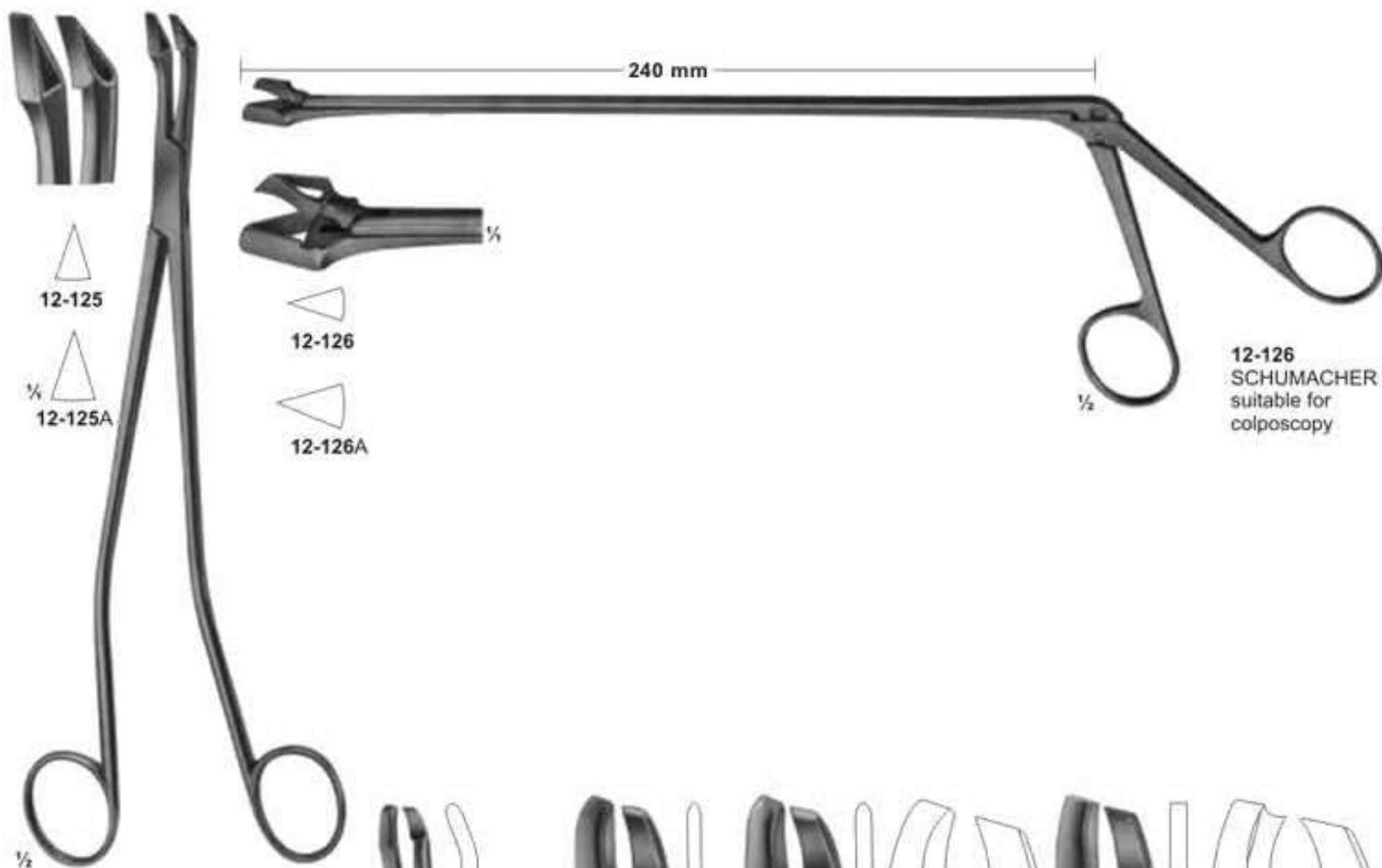

12-125

12-125A

12-126

12-126A

12-126  
SCHUMACHER  
suitable for  
colposcopy

12-125  
SCHUMACHER  
240mm

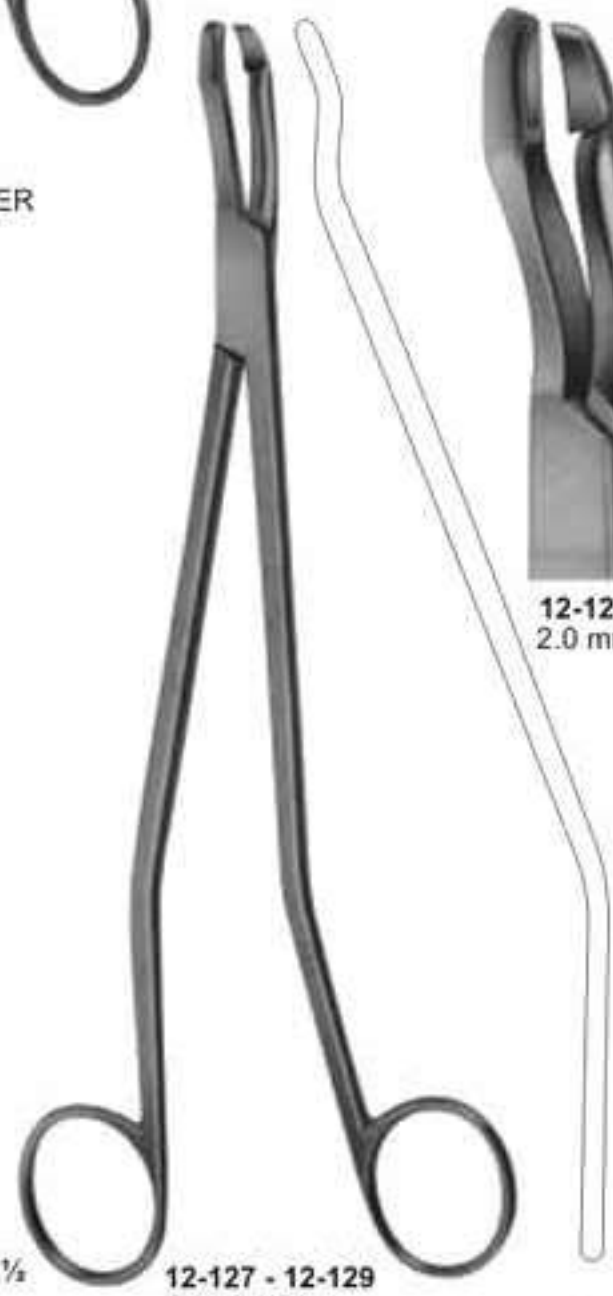

12-127  
2.0 mm

12-128  
2.4 mm

12-129  
2.4 mm

12-127 - 12-129  
SEIDL DBP  
Biopsy forceps, bayonet shaped  
for portio, vagina and vulva  
240mm

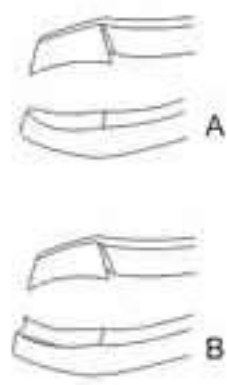

# Biopsy Forceps

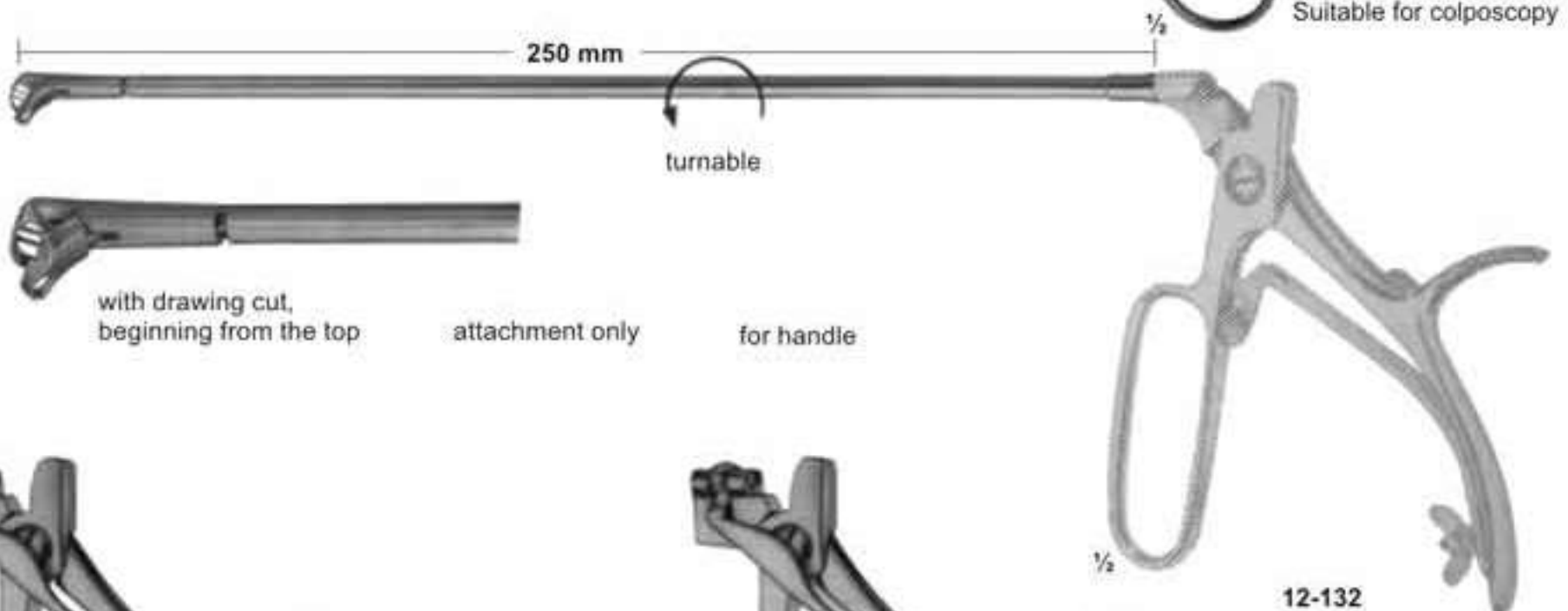
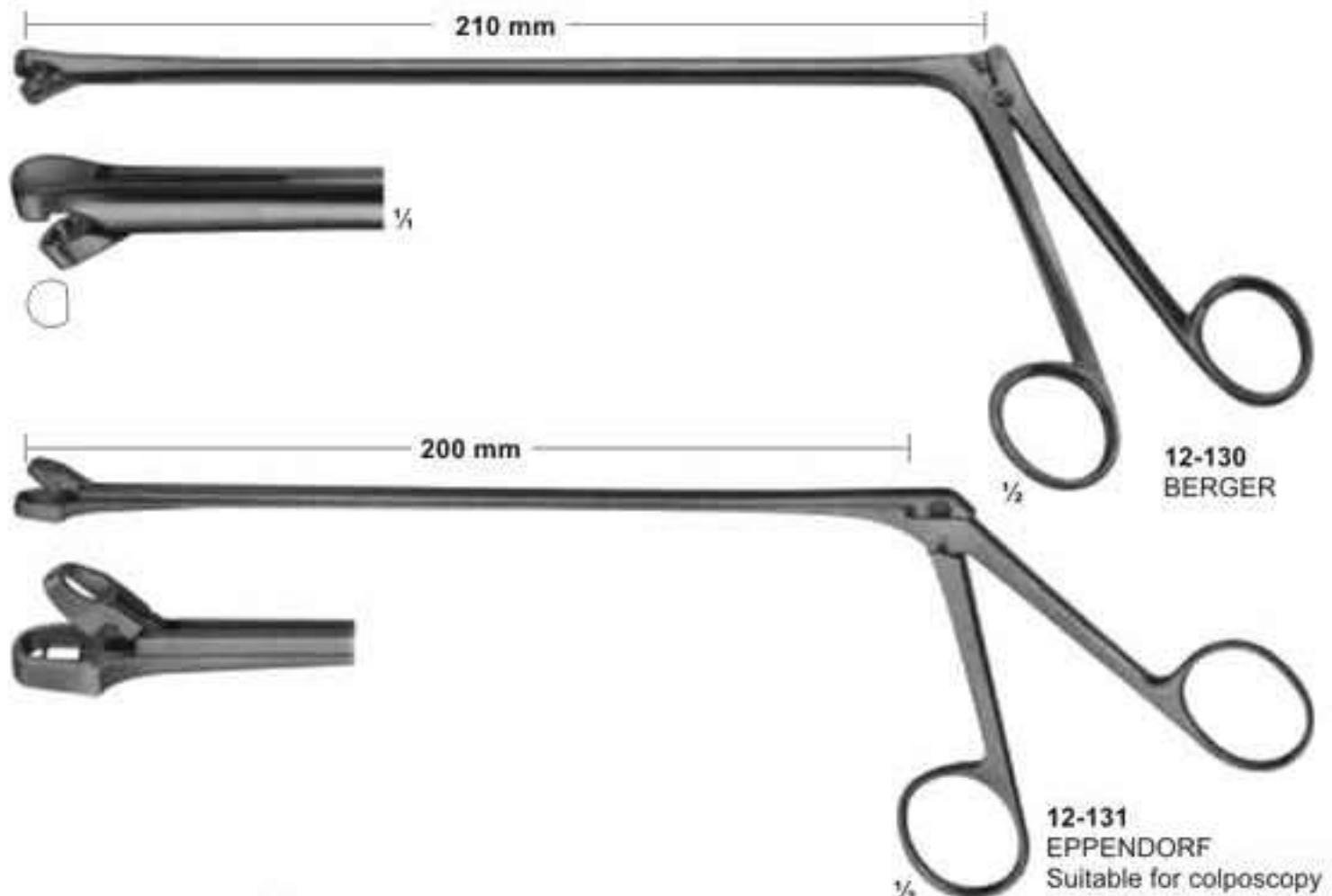

# Uterine Scoops

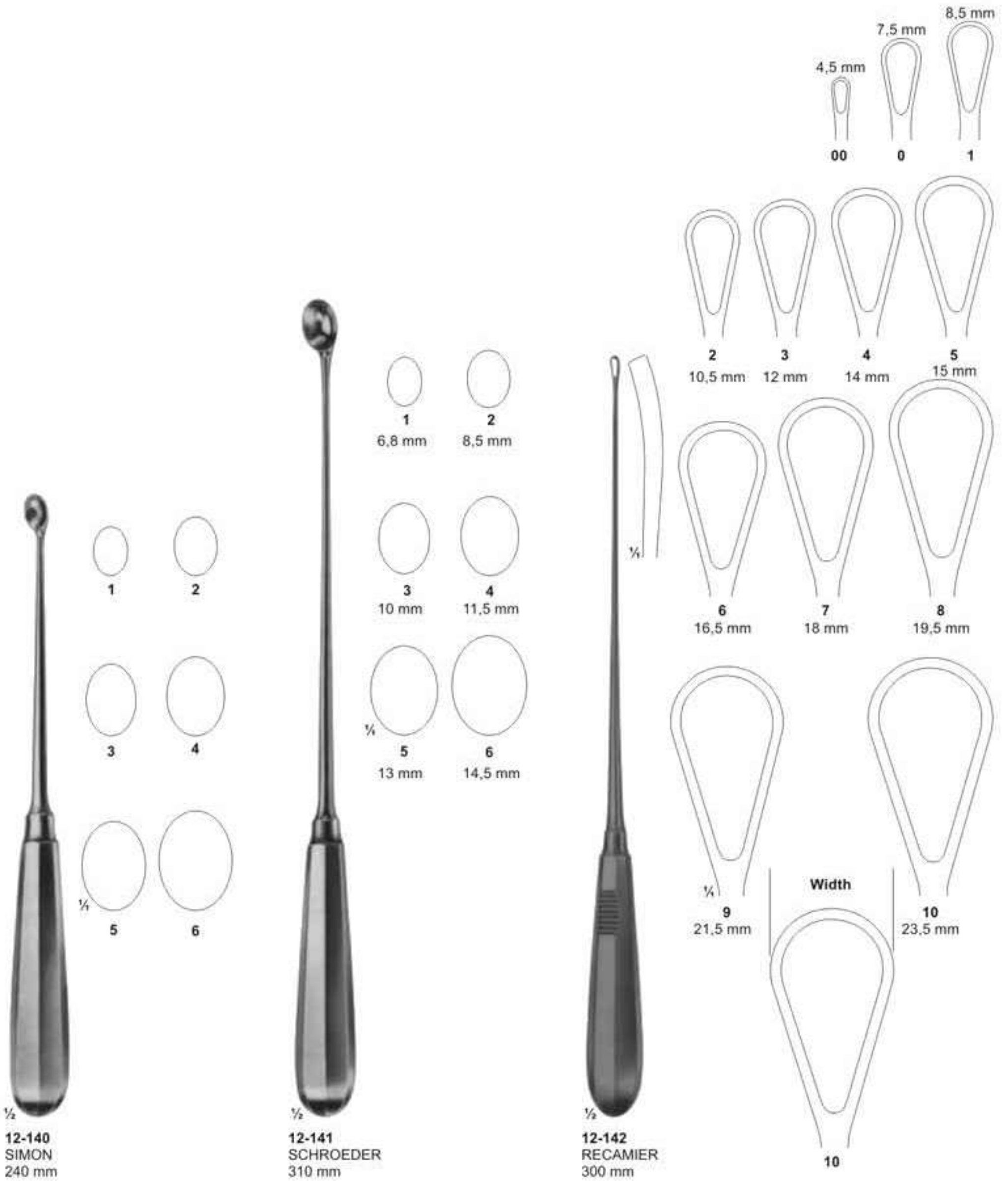

## Obstetrical Forceps



1/3

**13-101**  
NAEGELE  
355 mm



1/3

**13-102**  
NAEGELE  
400 mm



1/3

**13-103**  
SIMPSON-BRAUN  
305mm



# Obstetrics- Placenta and Ovum Forceps

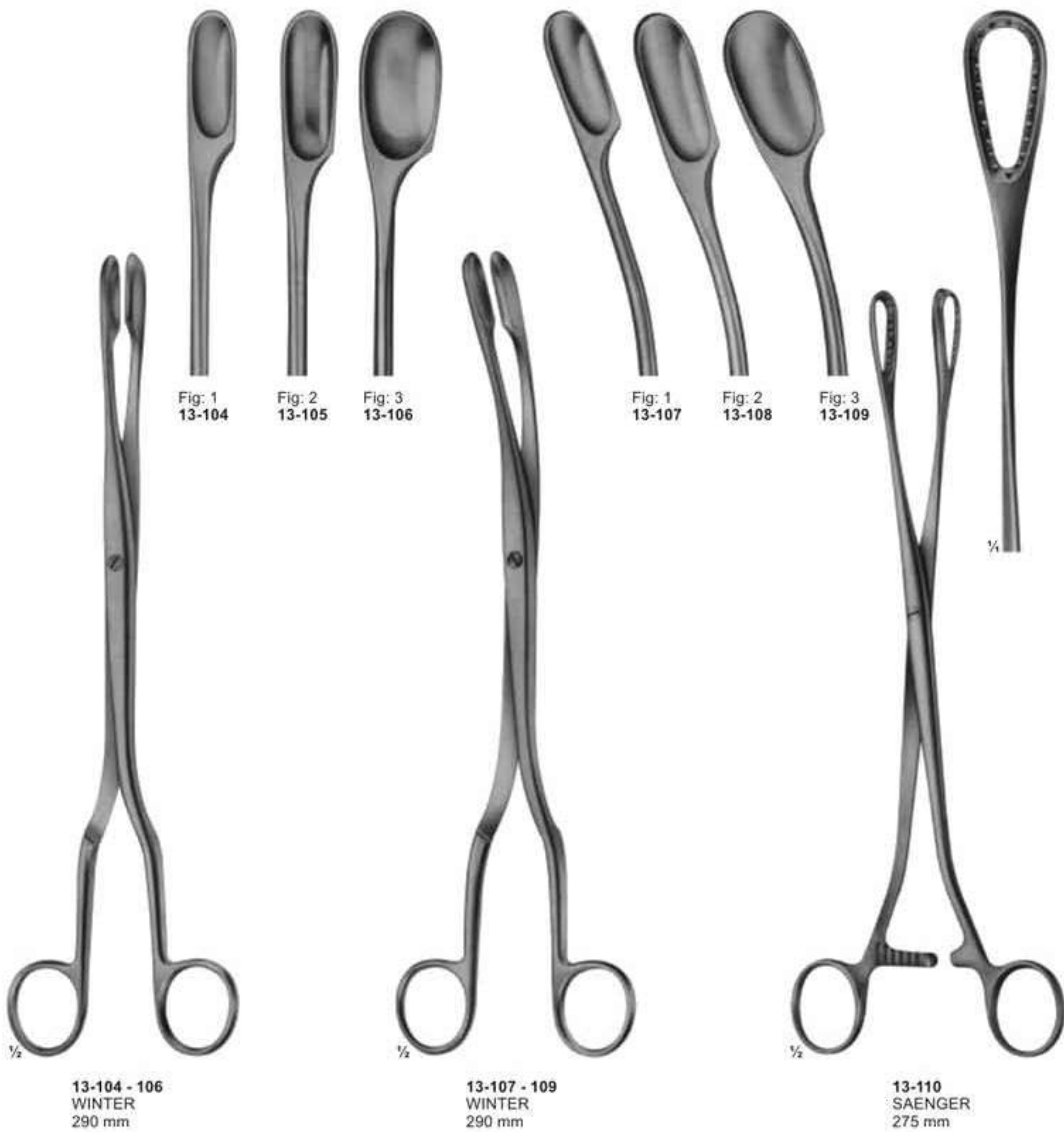

## Tongue and Tracheal Hooks and Dilators



13-111  
BOSE  
165 mm



13-112  
BOSE  
165 mm



13-113 - 115  
180 mm



13-113  
sharp



13-114  
blunt



13-115  
stumpf/blunt



13-116  
FINSEN  
50 mm



13-117  
FINSEN  
70 mm



13-118  
TROUSSEAU  
120 mm



13-119  
LABORDE  
125 mm



13-120  
LABORDE  
strong pattern  
135 mm



13-121  
Cleaning Brush  
for tracheal tubes  
285 mm

# Vascular Spatulas

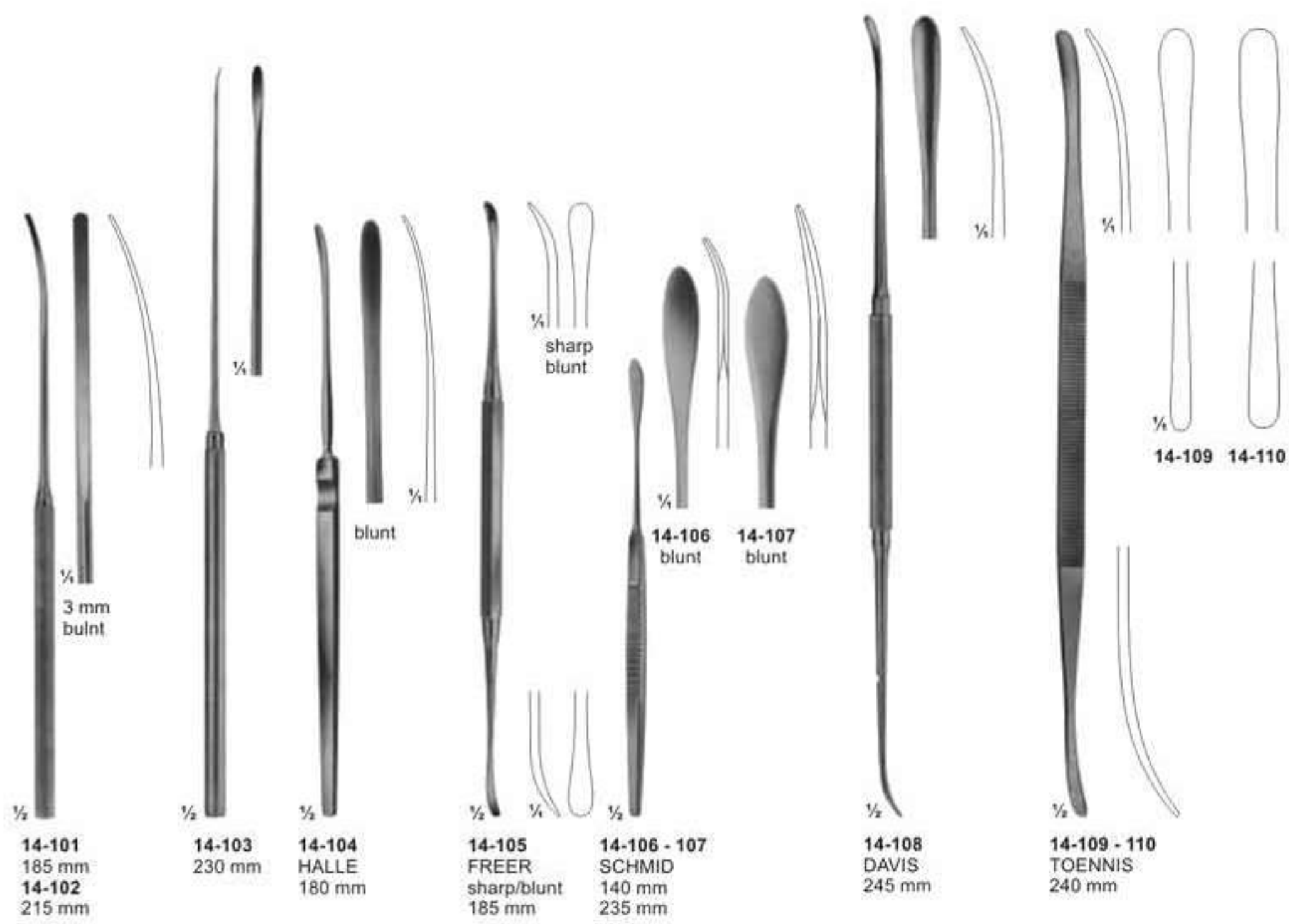

**14-101**  
185 mm  
**14-102**  
215 mm

**14-103**  
230 mm

**14-104**  
HALLE  
180 mm

**14-105**  
FREER  
sharp/blunt  
185 mm

**14-106 - 107**  
SCHMID  
140 mm  
235 mm

**14-108**  
DAVIS  
245 mm

**14-109 - 110**  
TOENNIS  
240 mm

# ATRAUMATA Forceps

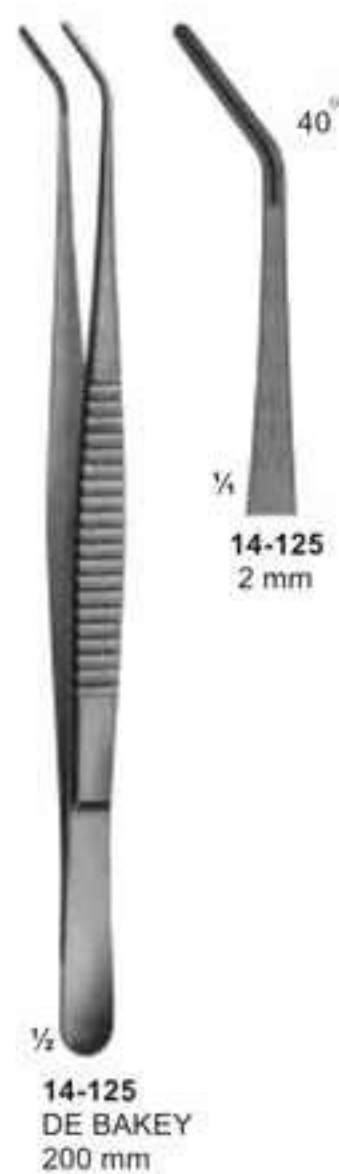
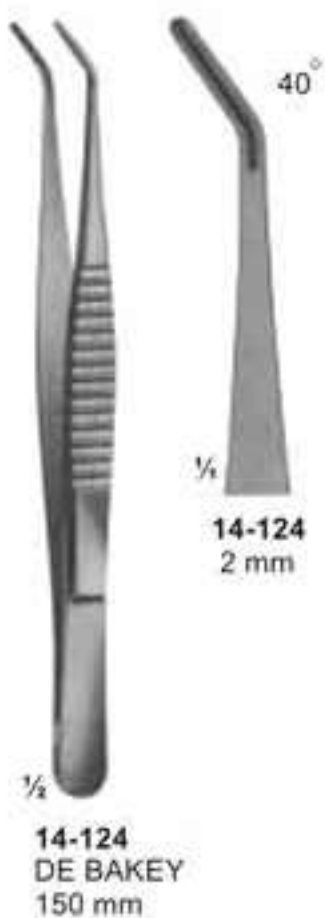
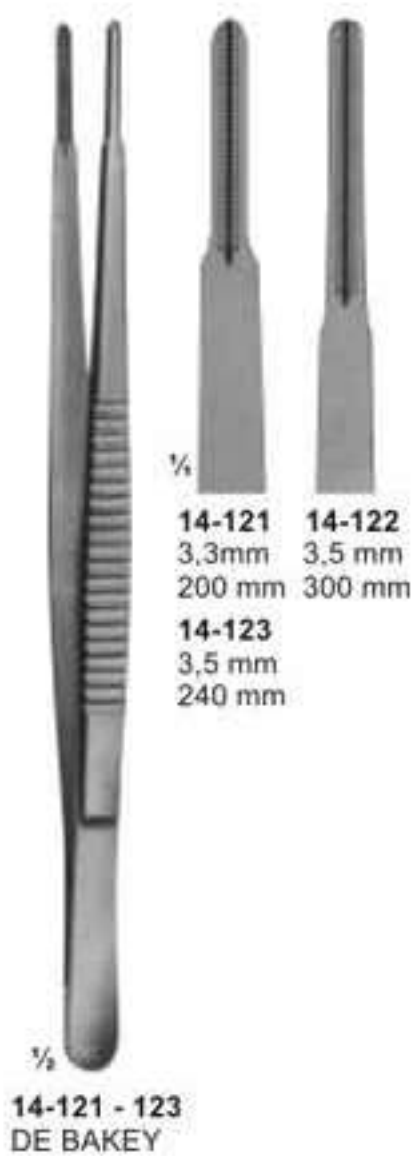
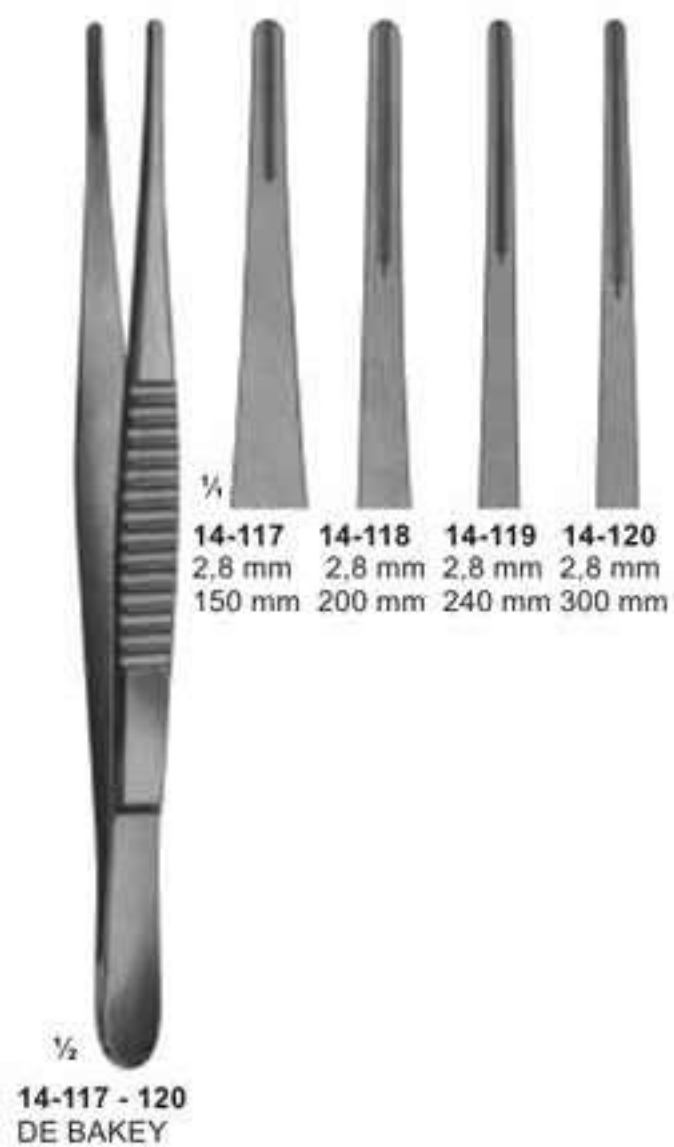
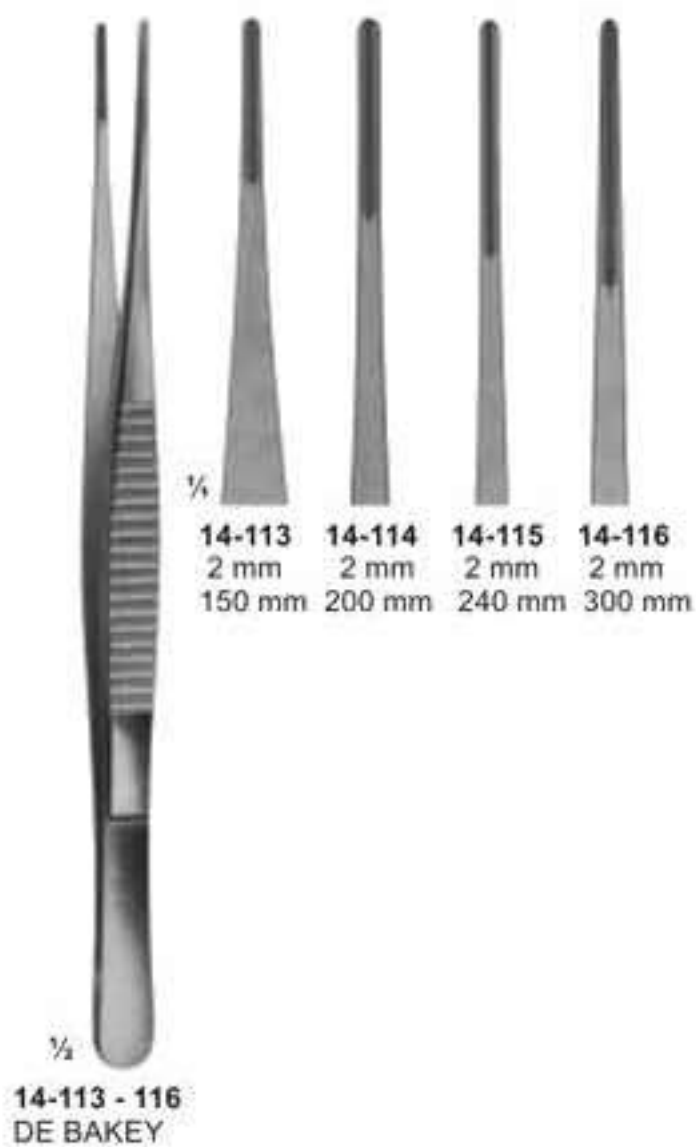
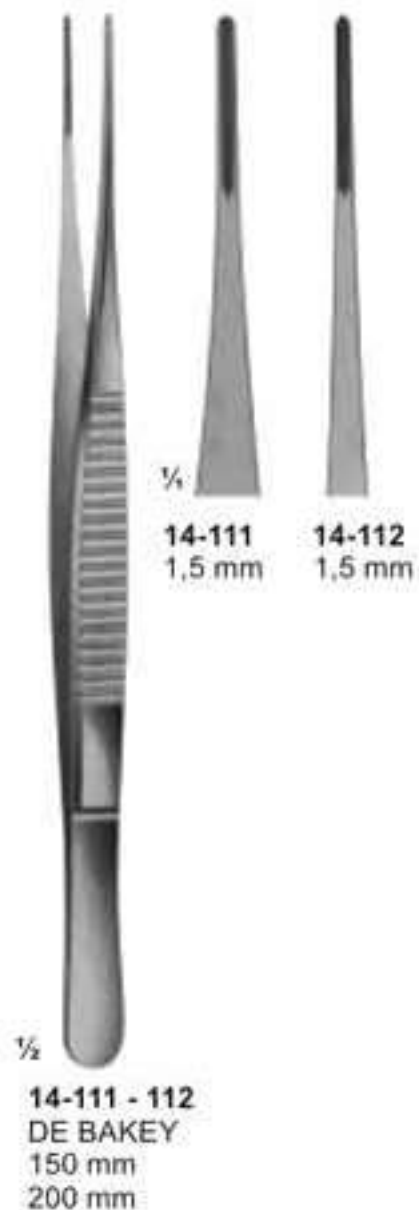

**ATRAUMATA**  
Anastomosis- and Multi- Purpose-  
Clamps- Pediatric types

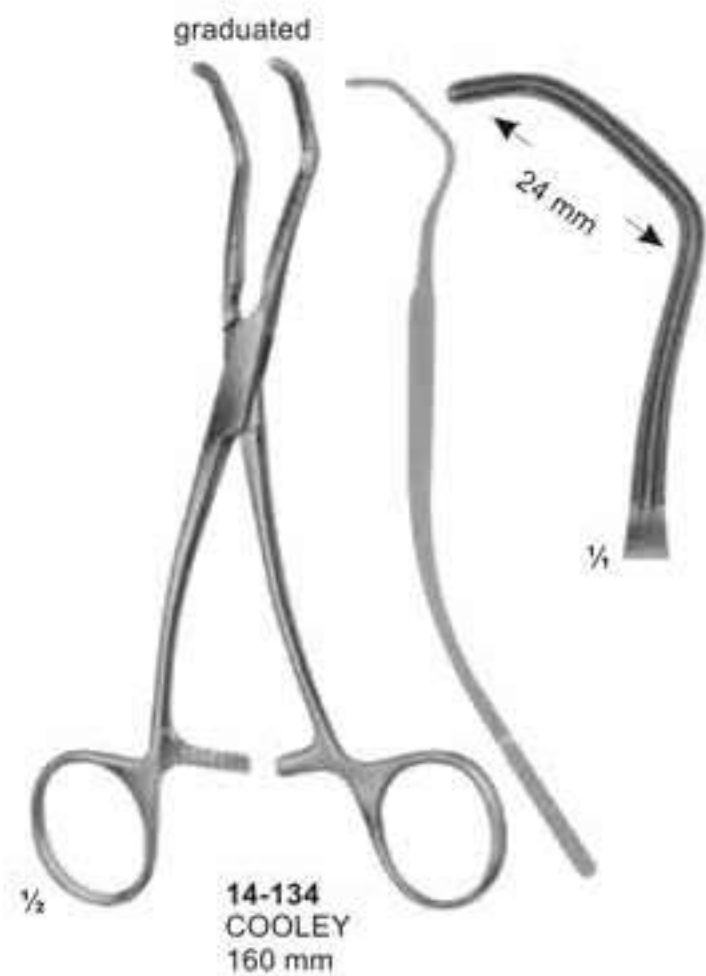
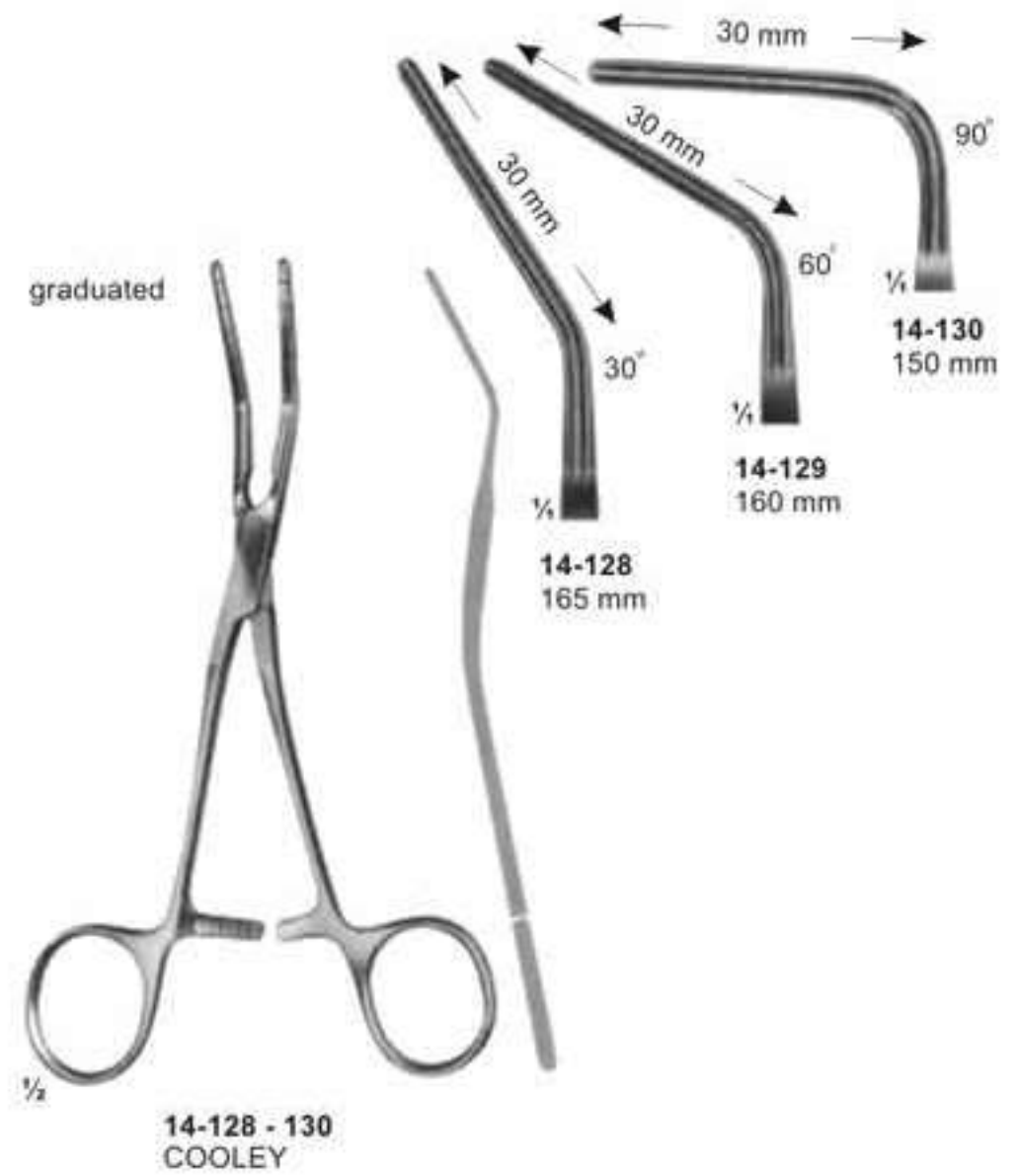
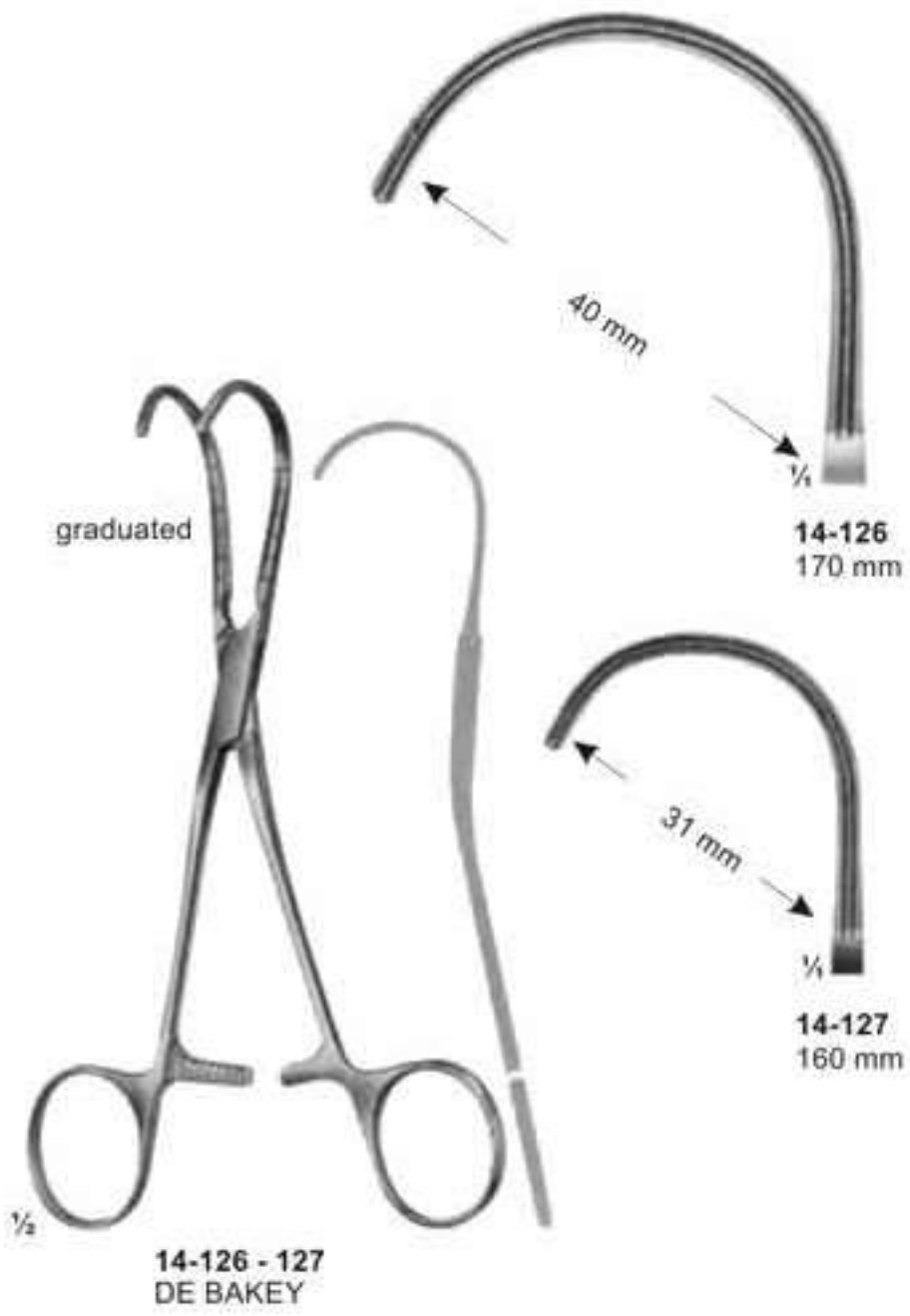

**ATRAUMATA**  
Coarctation Clamps, Patent-Ductus &  
Peripheral-Vascular Clamps

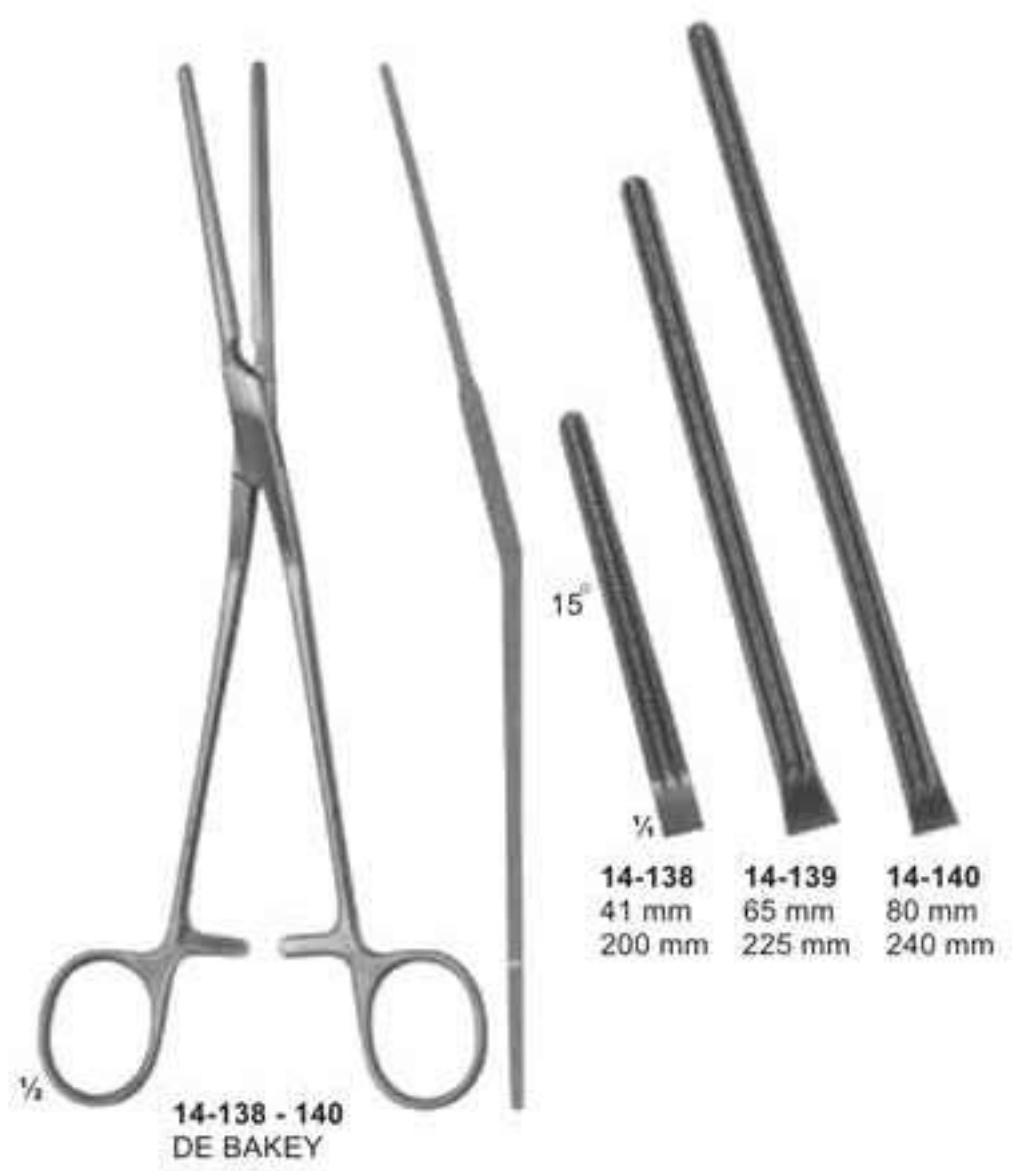

# Aorta- Anastomosis Clamps



L  
14-144  
WEBER  
260 mm

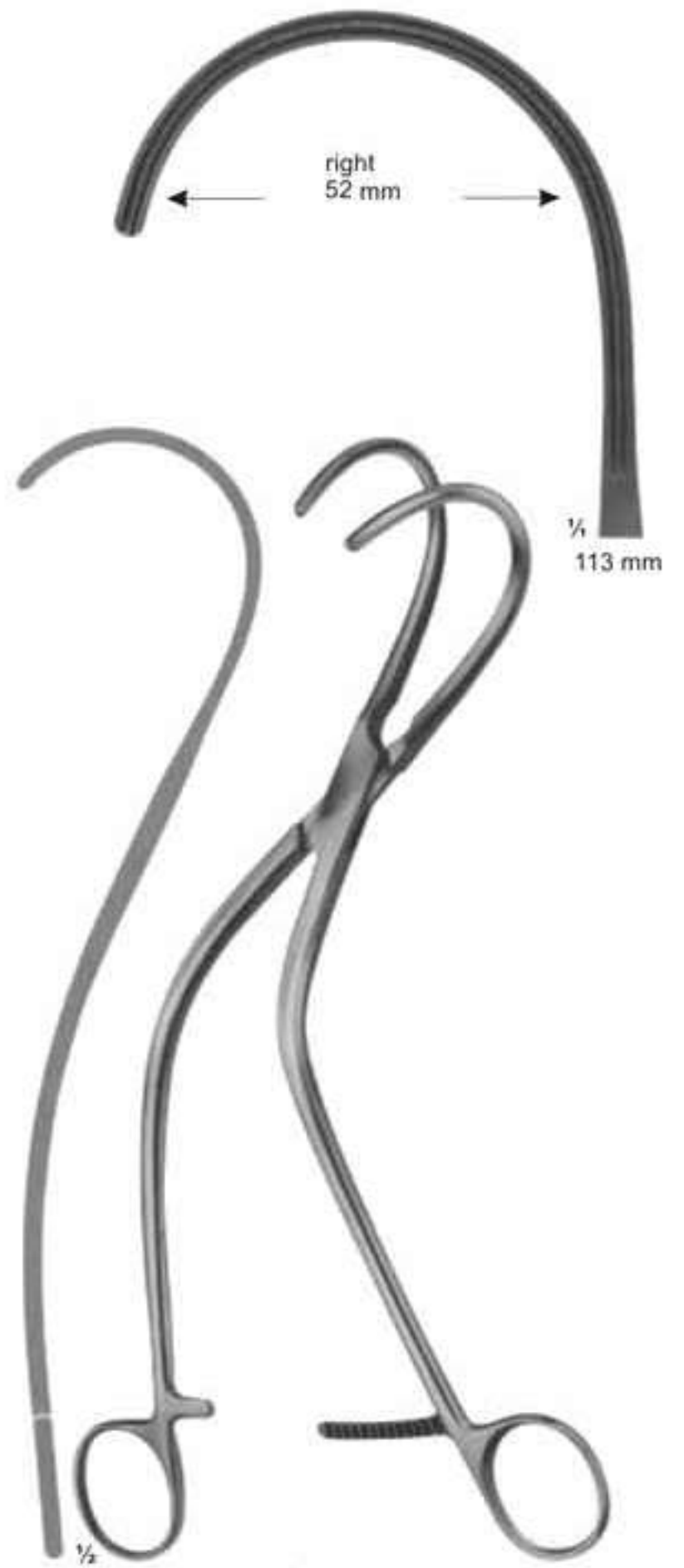

R  
14-145  
WEBER  
260 mm

## Multi- Purpose-Clamps



1/2  
14-146 - 149  
DE BAKLEY

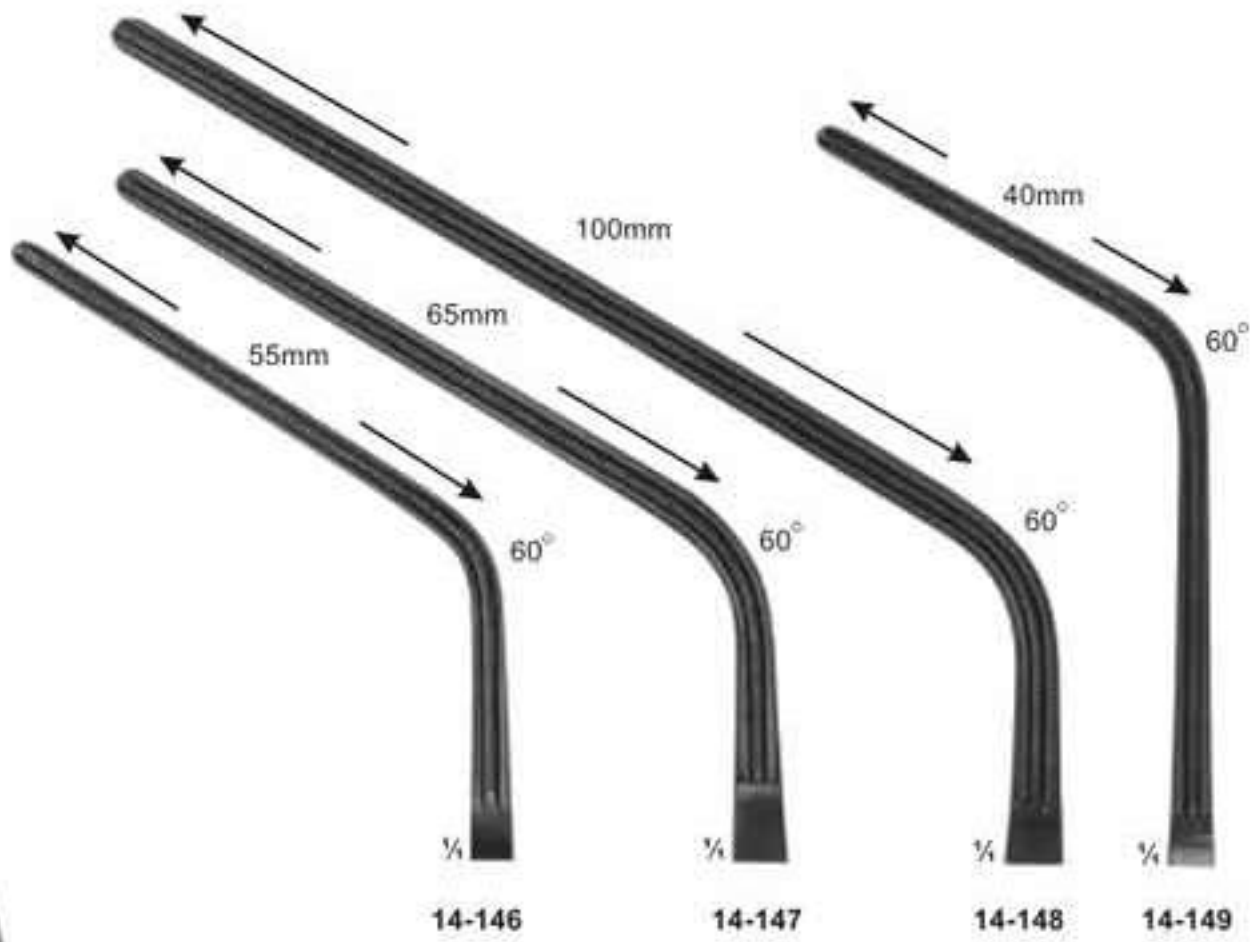

Total Length:	230 mm	280 mm	305 mm	240 mm
Length of jaws:	85 mm	100 mm	135 mm	93 mm



1/2  
14-150 - 153  
DE BAKLEY

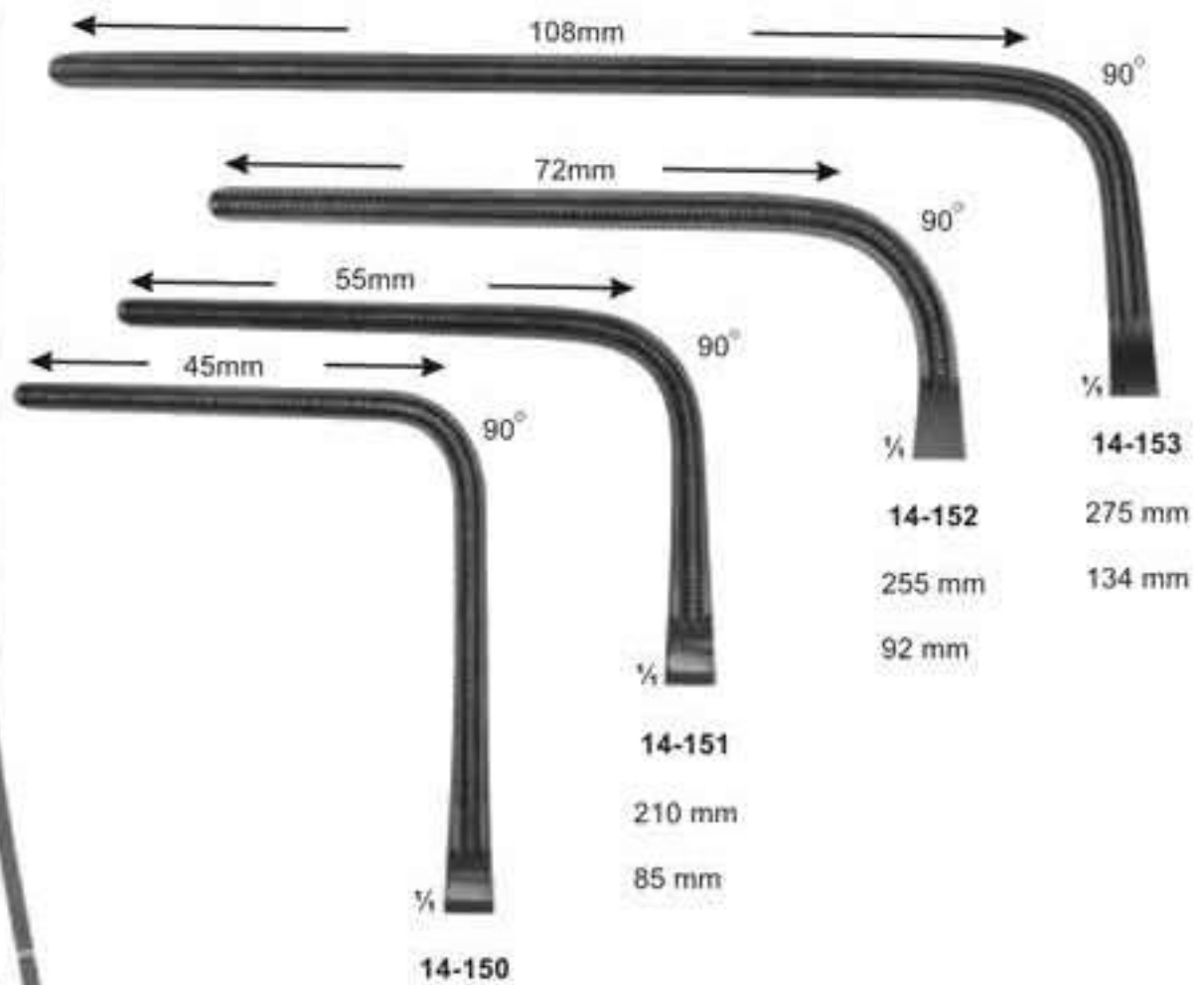

Total Length:	225 mm	275 mm	255 mm	210 mm
Length of jaws:	93 mm	134 mm	92 mm	85 mm



## Sternum Instruments and Rib Shears



14-154  
SCHUMACHER  
Sternum shears  
210 mm



14-155  
LEBSCHKE  
Sternum chisel  
200 mm



14-156  
230 mm



14-157  
COLLIN  
195 mm



14-158  
GLUCK  
190 mm



14-159  
BETHUNE  
340 mm



14-160  
BRUNNER  
Universal pattern  
340 mm



14-161  
GIERTZ-STILLE  
250 mm

# Rib Spreaders



**14-162**  
FINOCHIETTO  
Blades  
18X21 mm

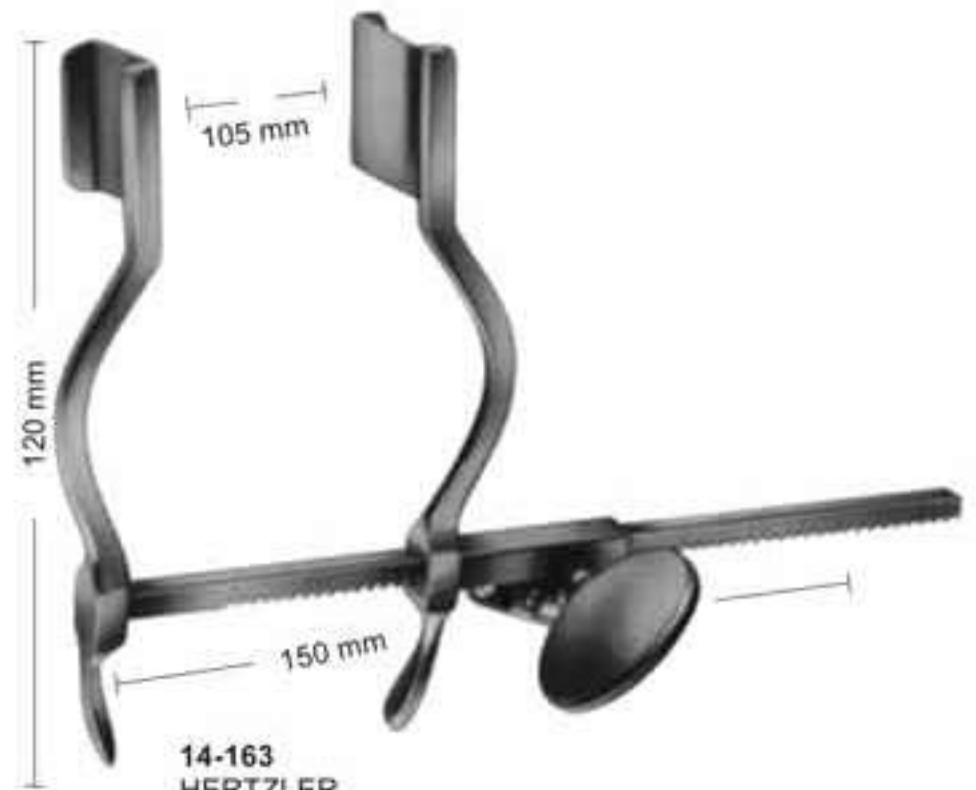

**14-163**  
HERTZLER  
Blades  
20X25 mm



**14-164**  
TUFFIER  
Blades  
43X53 mm

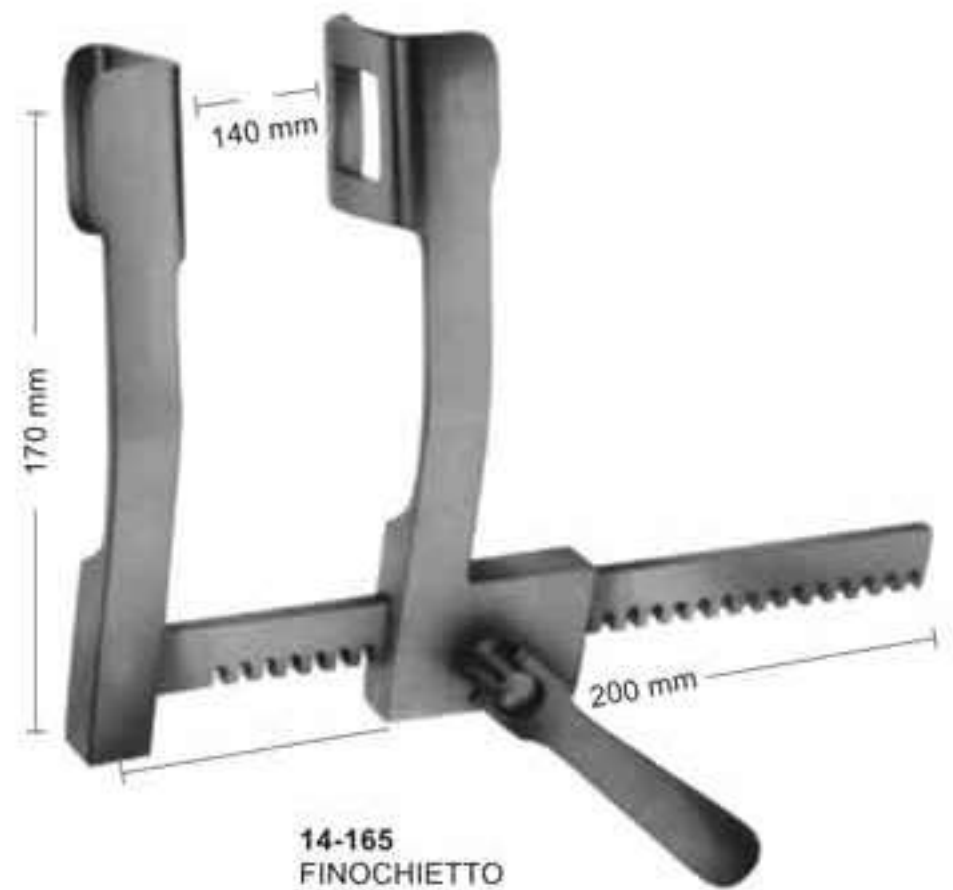

**14-165**  
FINOCHIETTO  
Blades  
36X45 mm

## Rib Spreaders-and Contractors



1/2

**14-166**  
SELLORS  
Rib spreader-and contractor  
with swivel blades  
200 mm



1/2

**14-167**  
BAILEY  
150 mm



**14-168**  
for children

**14-169**  
for adults

1/2

**14-168 - 169**  
BAILEY  
200 mm

# Punches

130°

upwards cutting

15-101  
1 mm 

KERRISON - JACOBY

FERRIS-SMITH-KERRISON

15-102  
2 mm 

15-103  
3 mm 

15-104  
4 mm 

15-105  
5 mm 

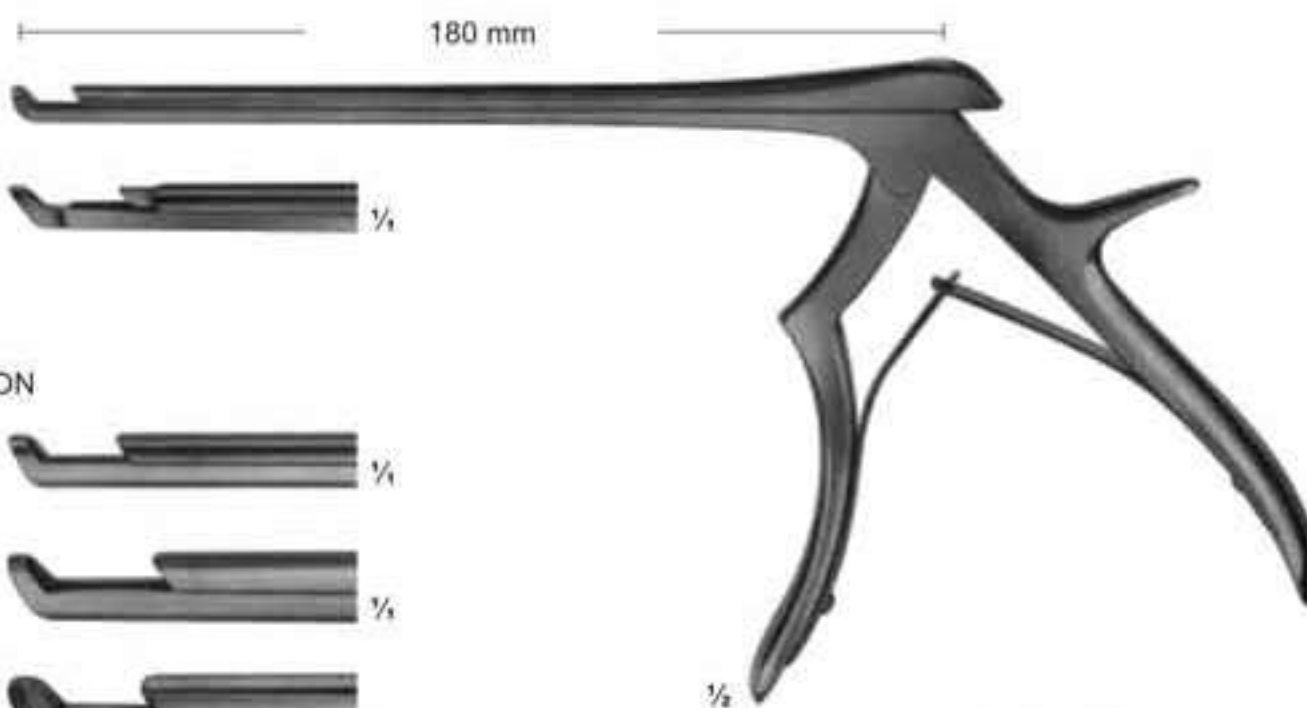

15-101 - 105

90°

upwards cutting

15-106  
1 mm 

KERRISON - JACOBY

15-107  
2 mm 

FERRIS-SMITH-KERRISON

15-108  
3 mm 

15-109  
4 mm 

15-110  
5 mm 

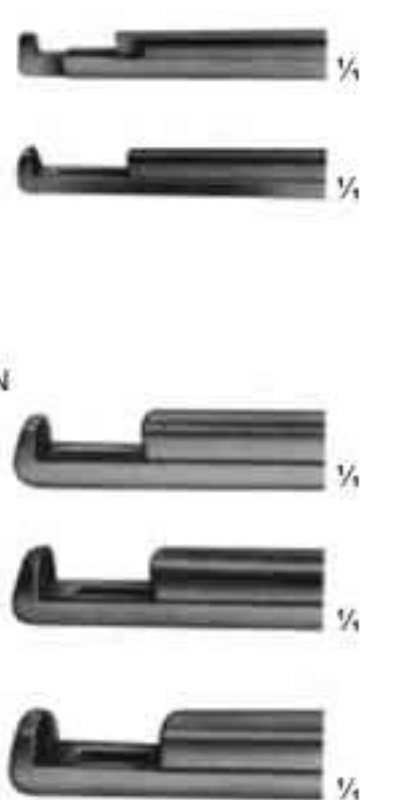
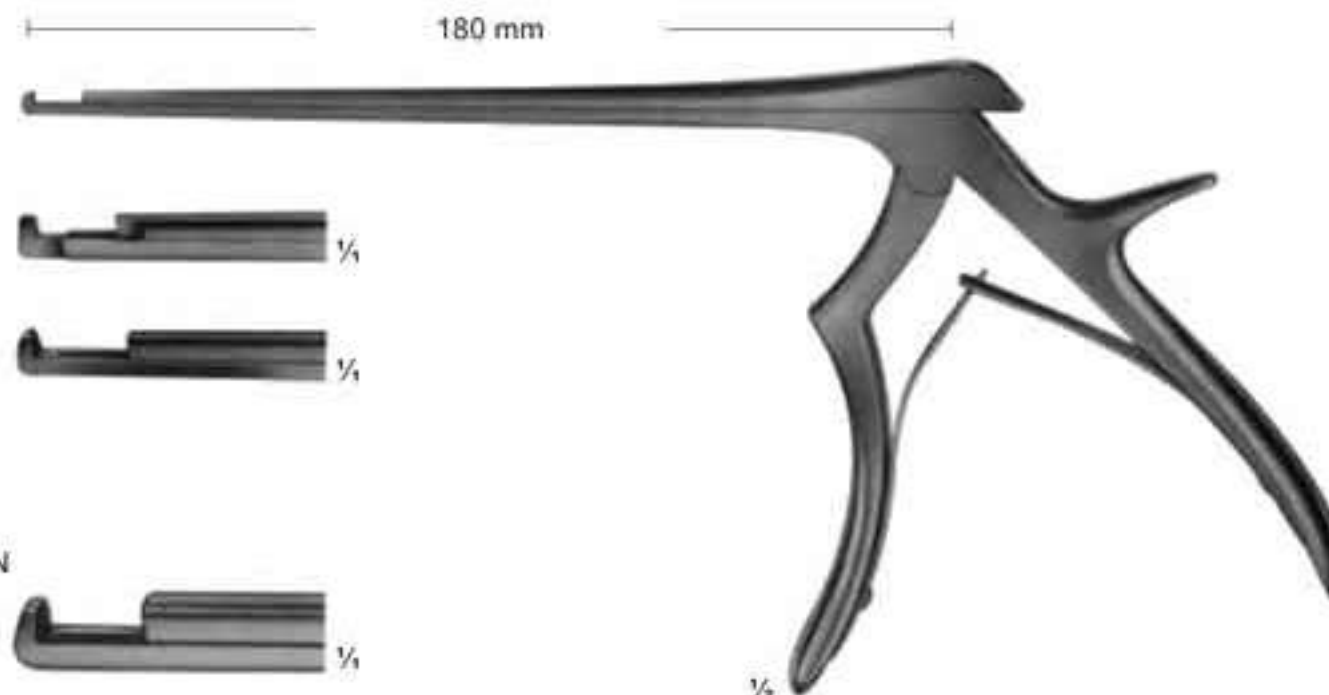

15-106 - 110

Punches

90° upwards cutting

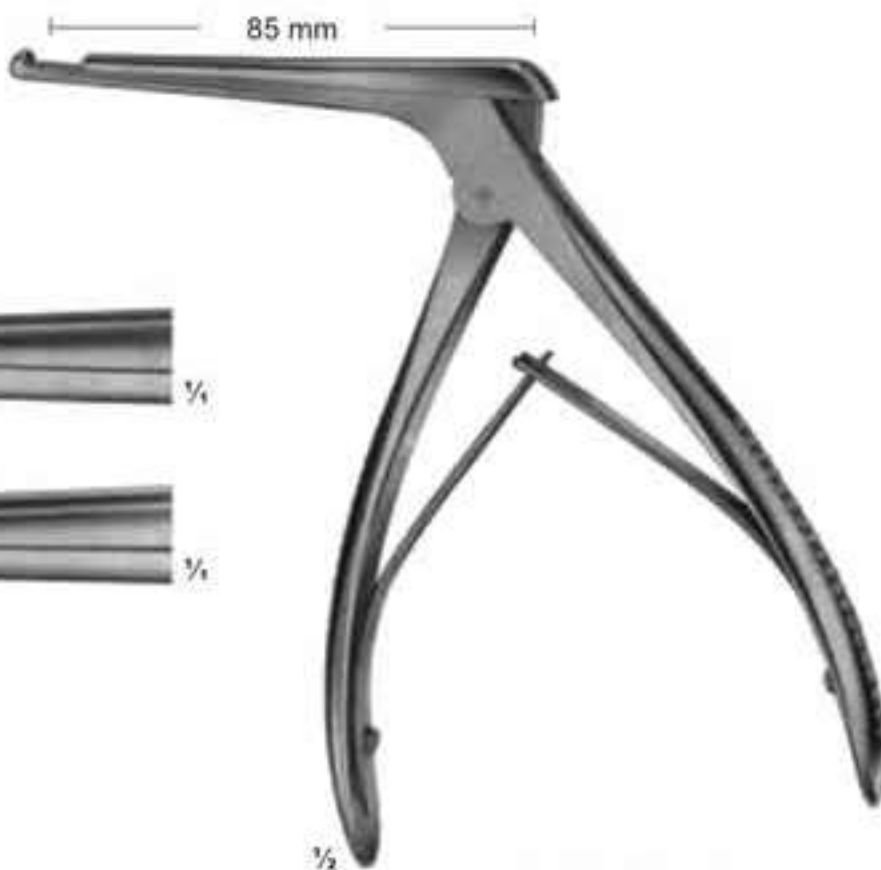

15-111  
4 mm



15-112  
5 mm



15-111 - 15-112  
KERRISON

90° upwards cutting

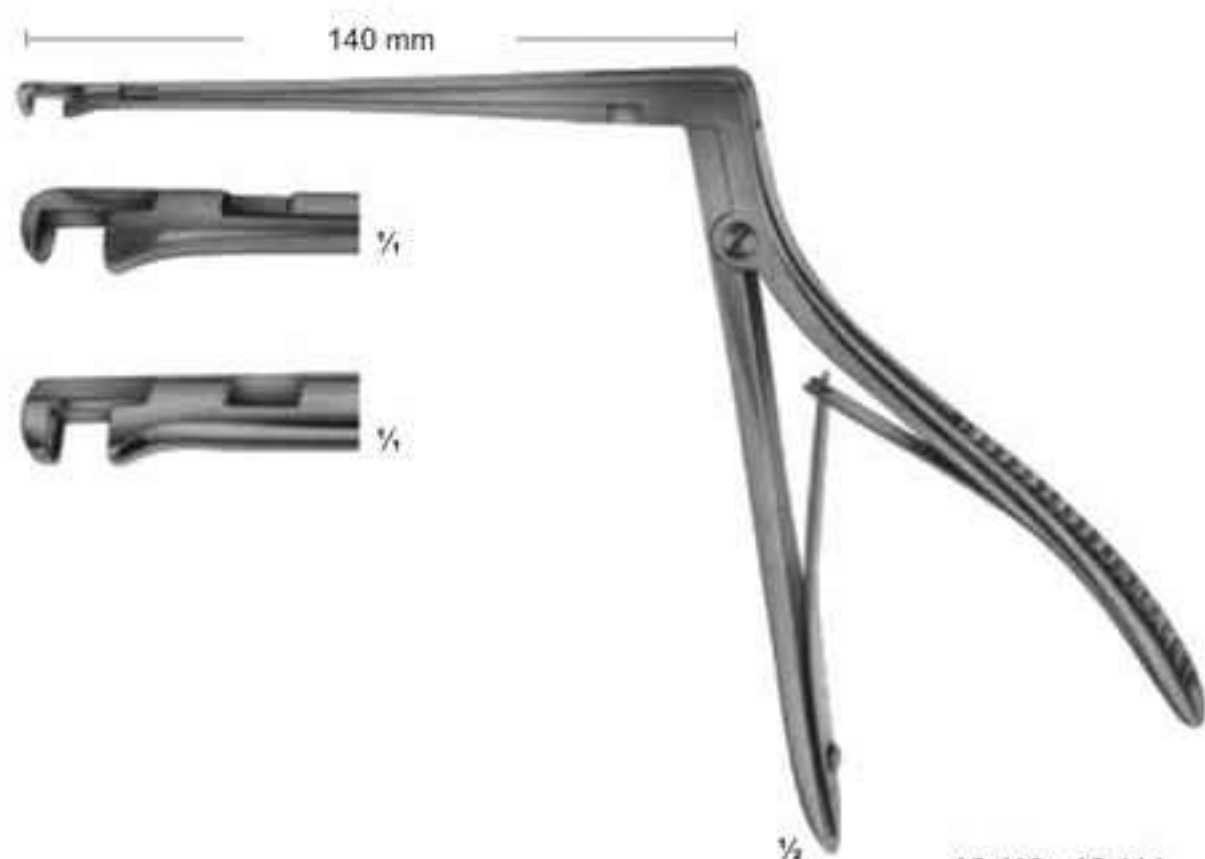

15-113  
3.3 mm



15-114  
4.0 mm



15-113 - 15-114  
HAJEK-KOFLER

Rongeurs

LOVE-GRUENWALD

15-115  
2 X 10 mm

15-116  
3 X 10 mm

SPURLING  
15-117  
4 X 10 mm



15-115 - 15-117

15-118  
2 mm

15-119  
3 mm

15-120  
4 mm

15-121  
5 mm

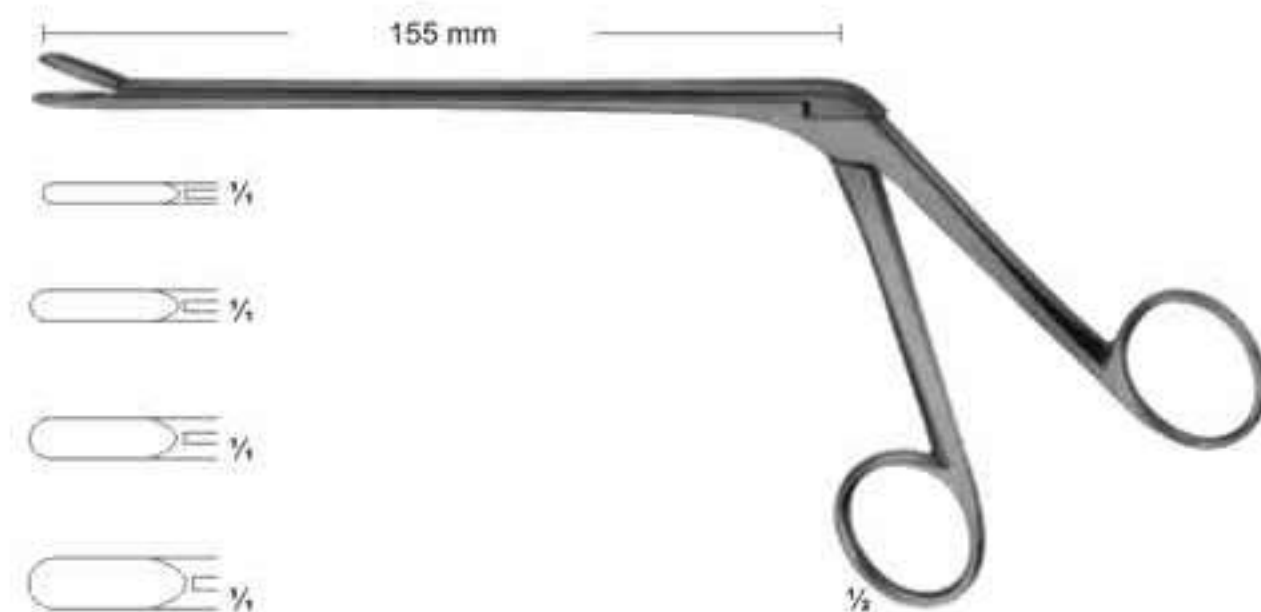

15-118 - 15-121  
CASPAR

150°

15-122  
2 mm

15-123  
3 mm

15-124  
4 mm

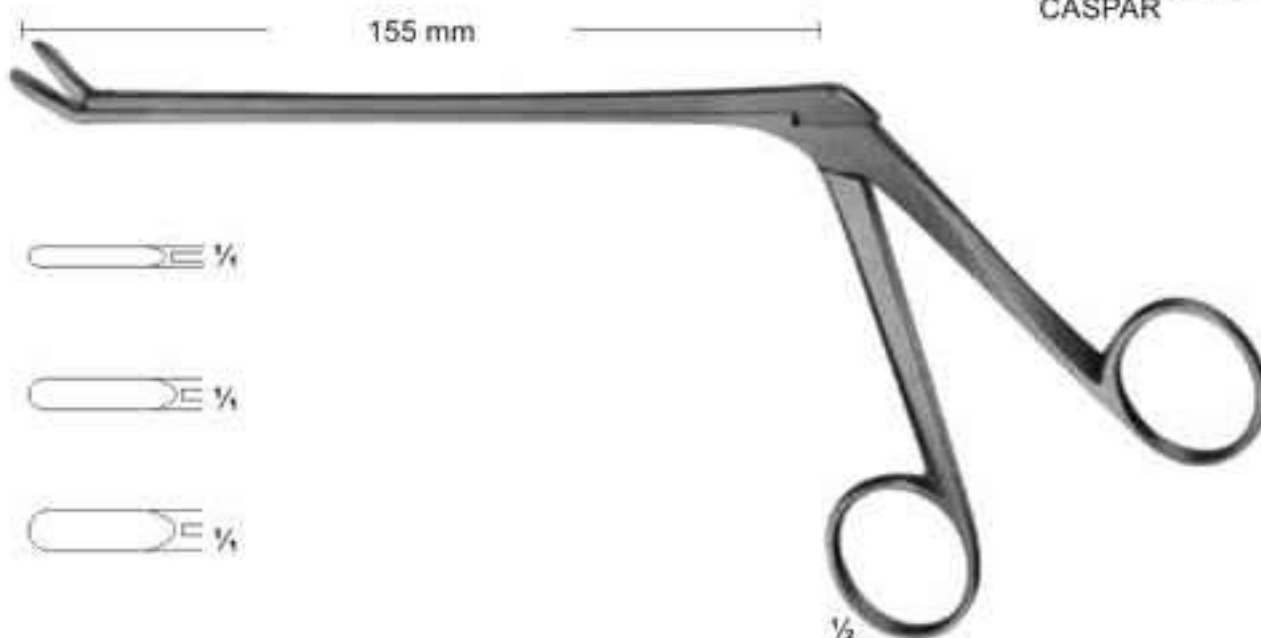

15-122 - 15-124  
CASPAR

# Rongeurs

Angled positions for rongeurs

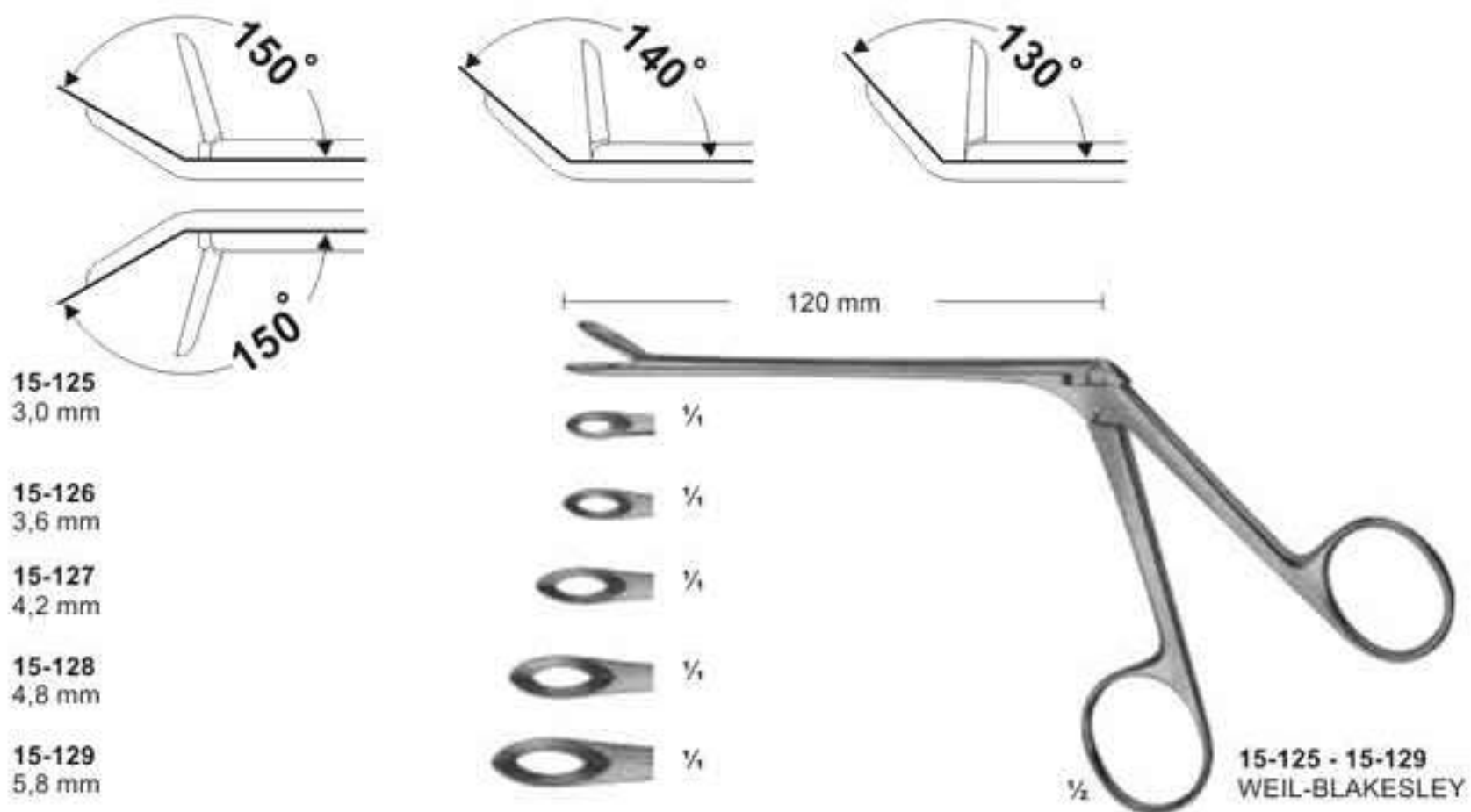

130°

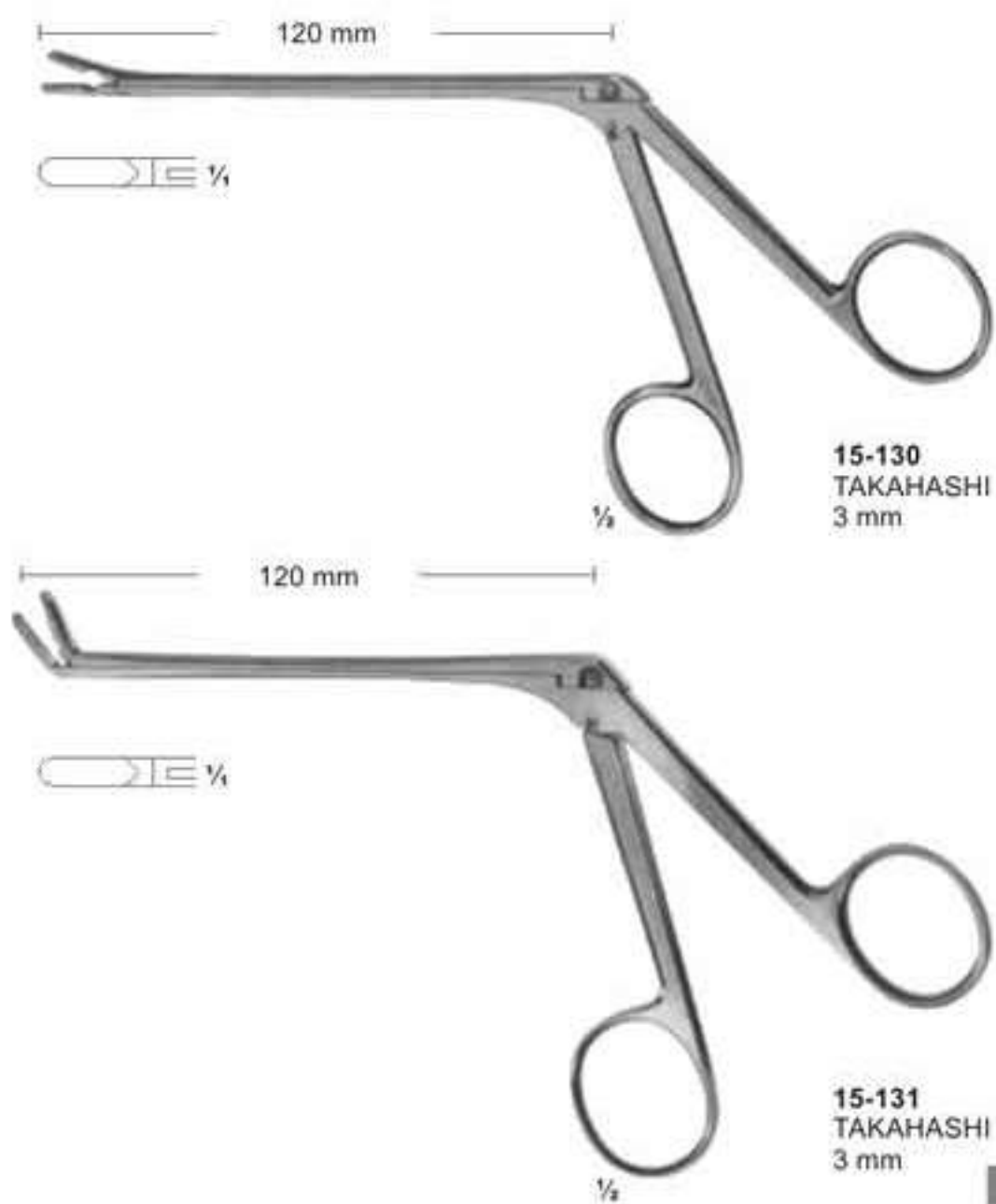

# Rongeurs

**150°**

Lower part of jaws movable

**15-132**  
2 mm

**15-133**  
3 mm

**15-134**  
4 mm



**15-132 - 15-134**  
CASPAR

Length of shaft 140 mm	Length of shaft 160 mm	Length of shaft 185 mm	size of jaws
<b>15-135</b>	<b>15-140</b>	<b>15-145</b>	2 X12 mm
<b>15-136</b>	<b>15-141</b>	<b>15-146</b>	3 X12 mm
<b>15-137</b>	<b>15-142</b>	<b>15-147</b>	4 X14 mm
<b>15-138</b>	<b>15-143</b>	<b>15-148</b>	5 X14 mm
<b>15-139</b>	<b>15-144</b>	<b>15-149</b>	6 X16 mm

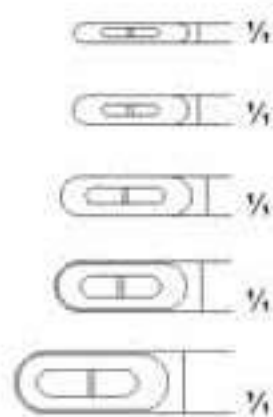

**15-135 - 15-149**  
CASPAR

**150°**

Length of shaft 140 mm	Length of shaft 160 mm	Length of shaft 185 mm	size of jaws
<b>15-150</b>	<b>15-153</b>	<b>15-156</b>	3 X12 mm
<b>15-151</b>	<b>15-154</b>	<b>15-157</b>	4 X14 mm
<b>15-152</b>	<b>15-155</b>	<b>15-158</b>	5 X14 mm

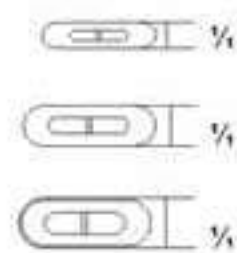

**15-150 - 15-158**  
CASPAR



Rongeurs

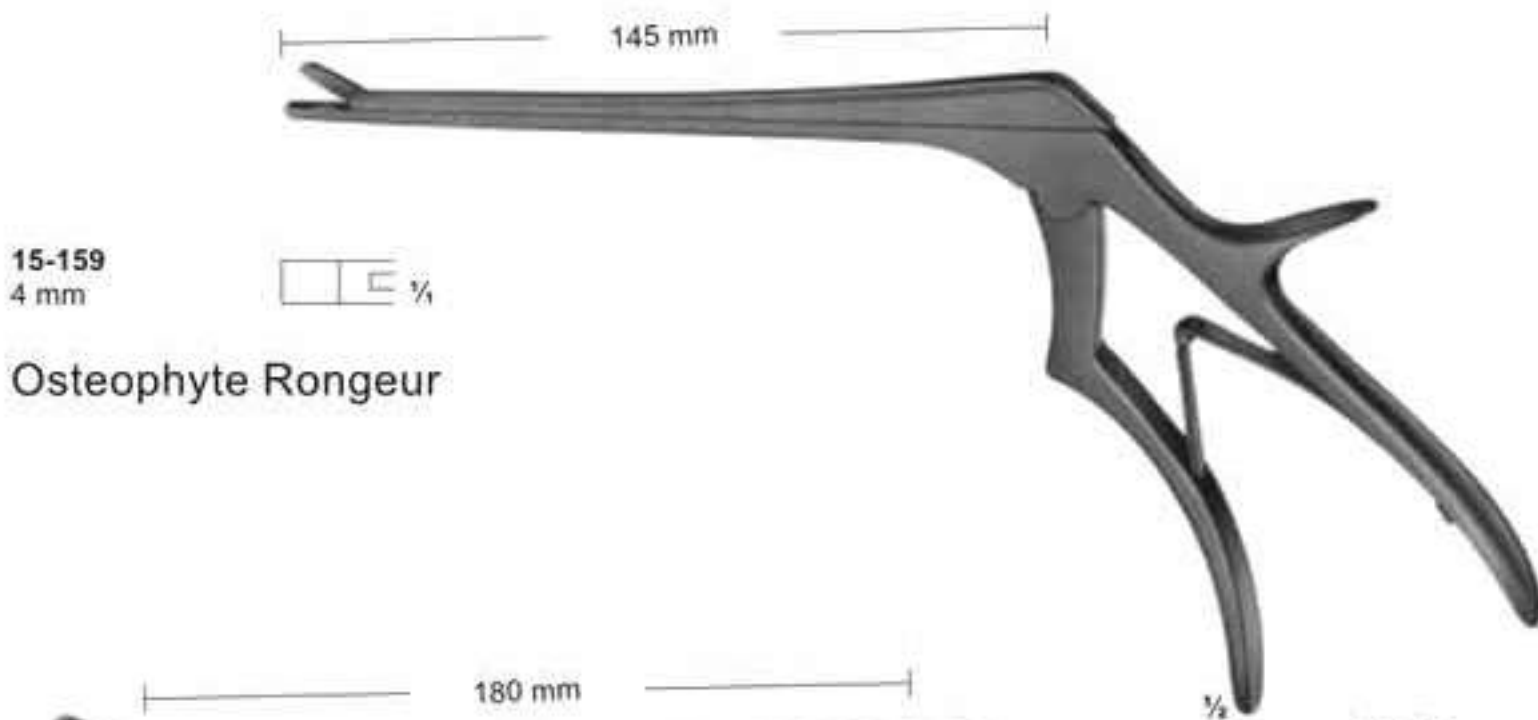

15-159  
4 mm

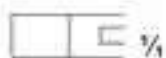

Osteophyte Rongeur

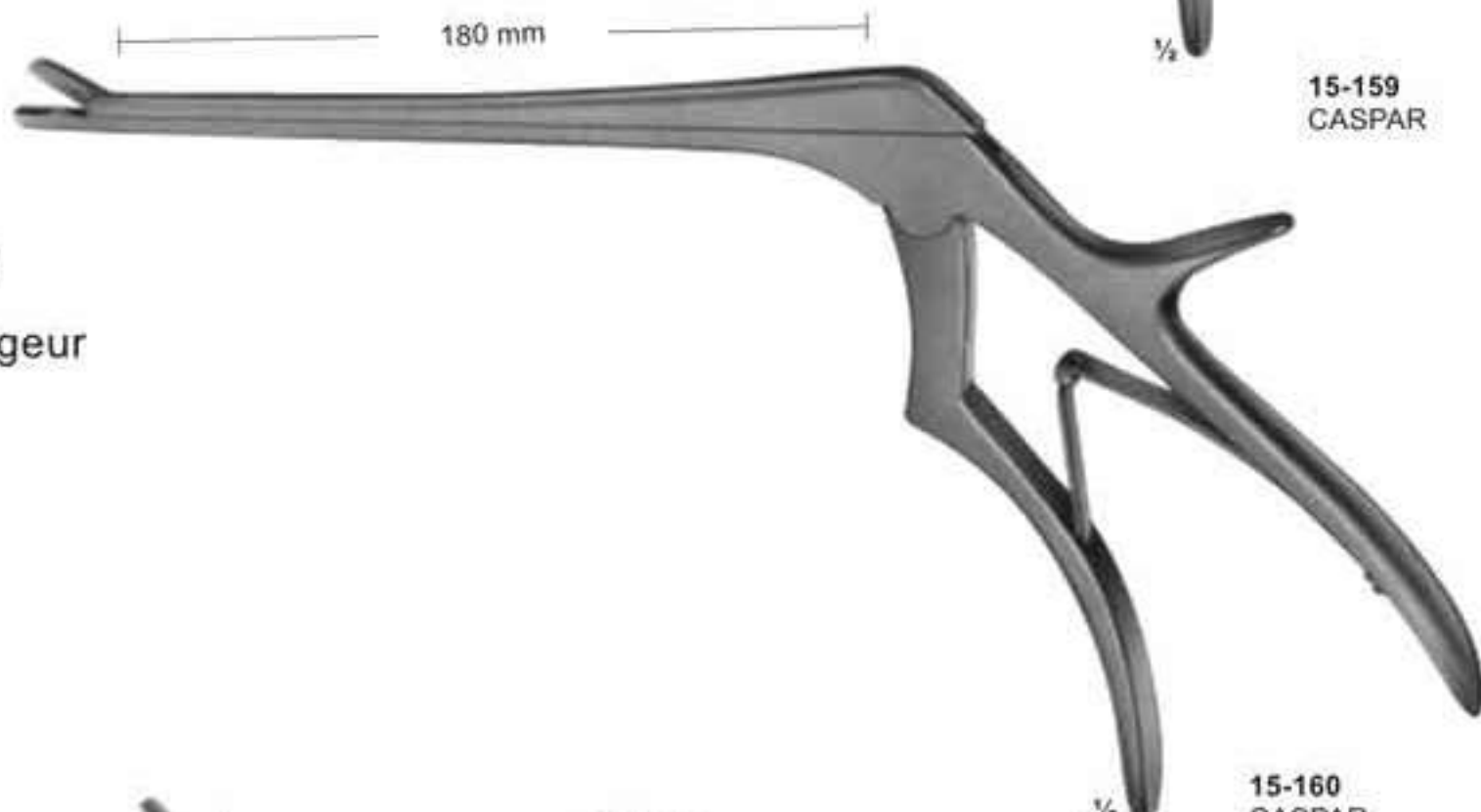

15-160  
4 mm

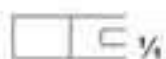

Osteophyte Rongeur

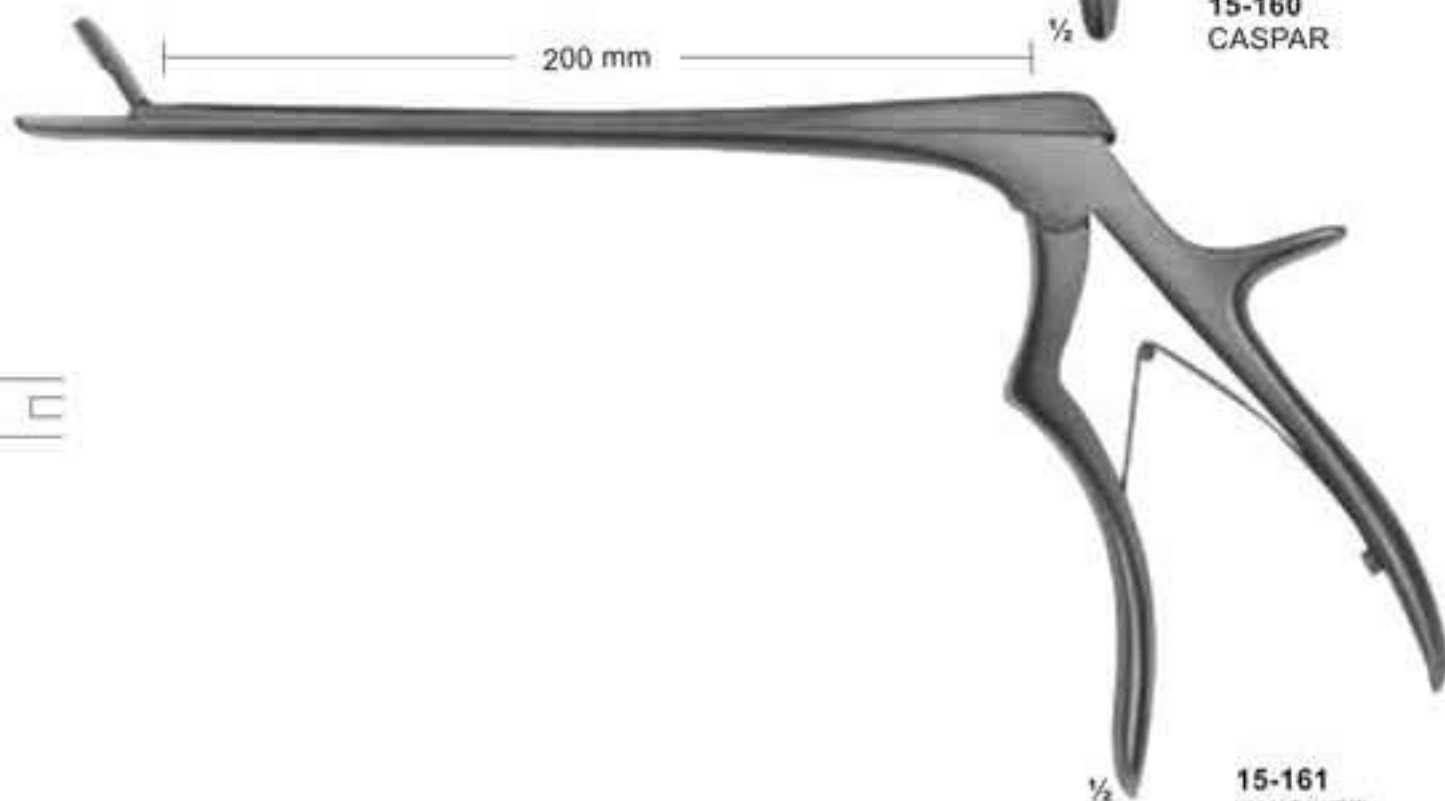

15-161  
5.5 mm



Very Heavy Pattern

15-159  
CASPAR

15-160  
CASPAR

15-161  
WAGNER

## Elevators and Bone Levers

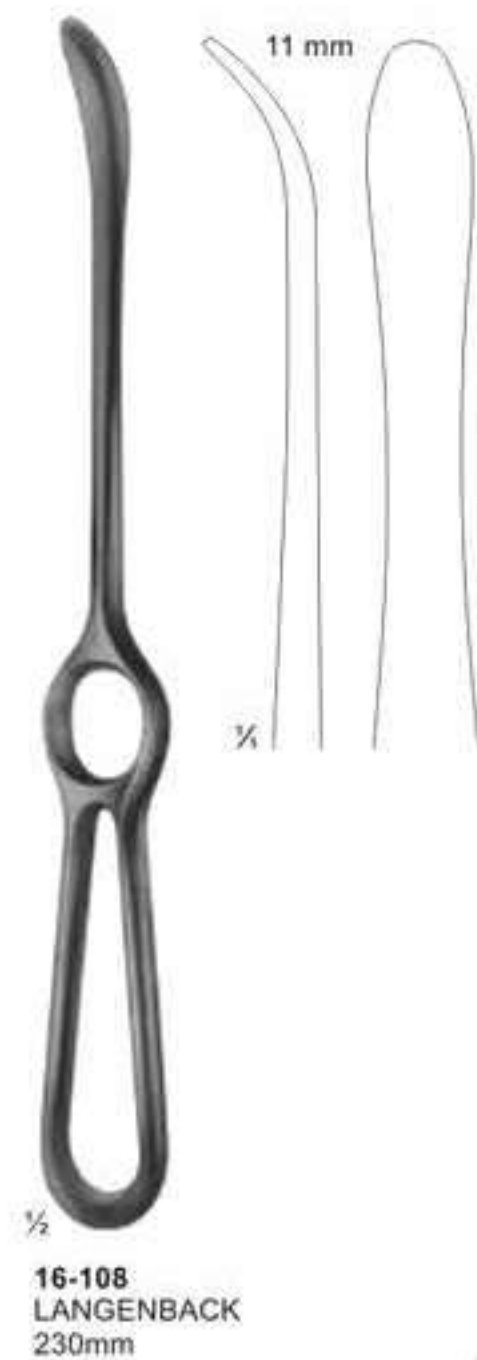
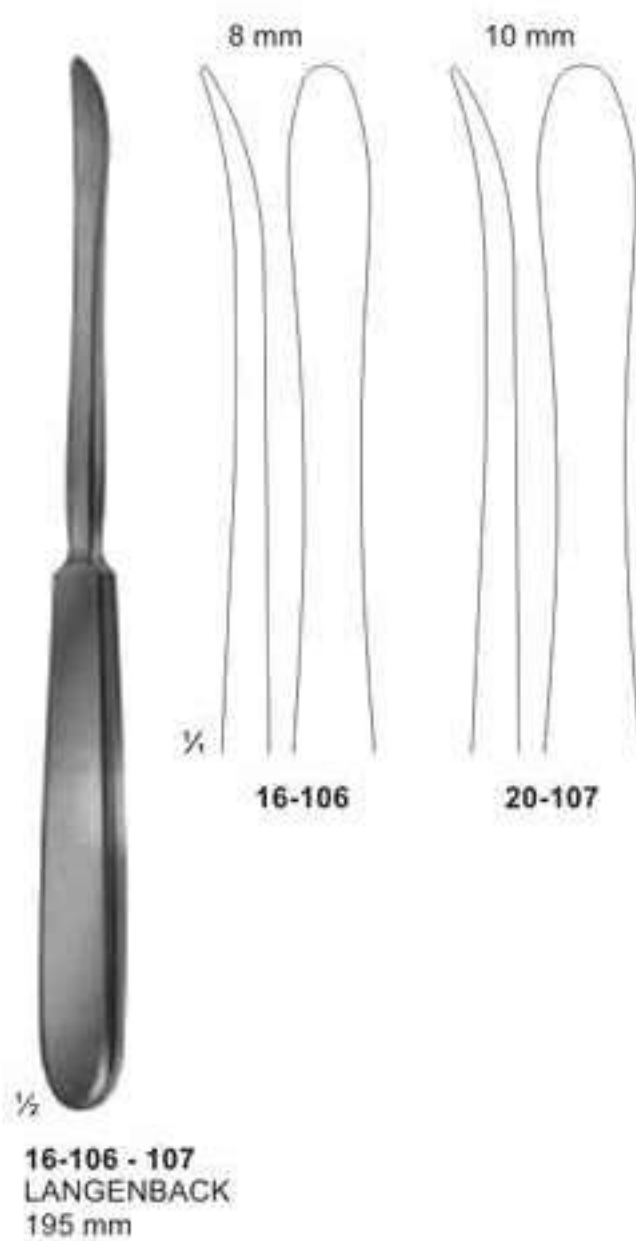
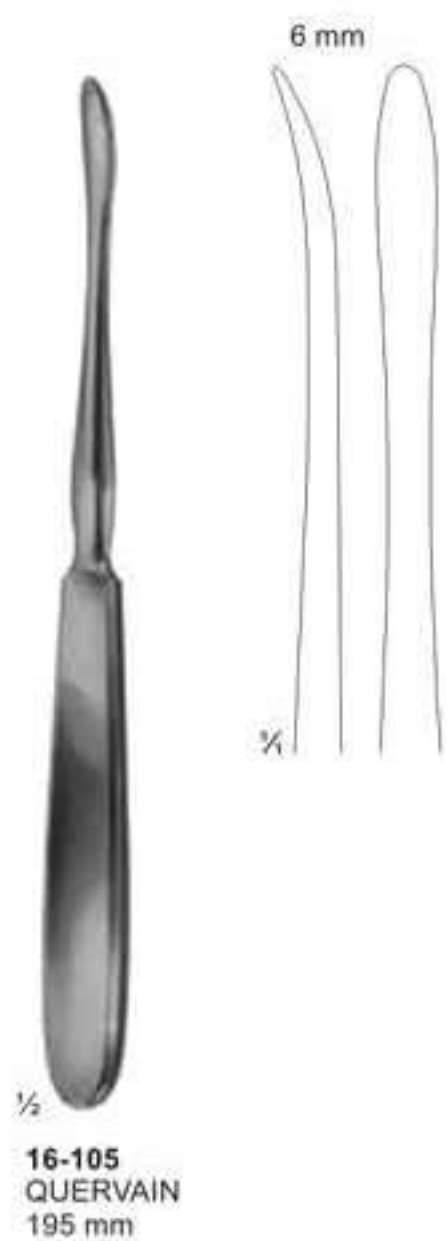
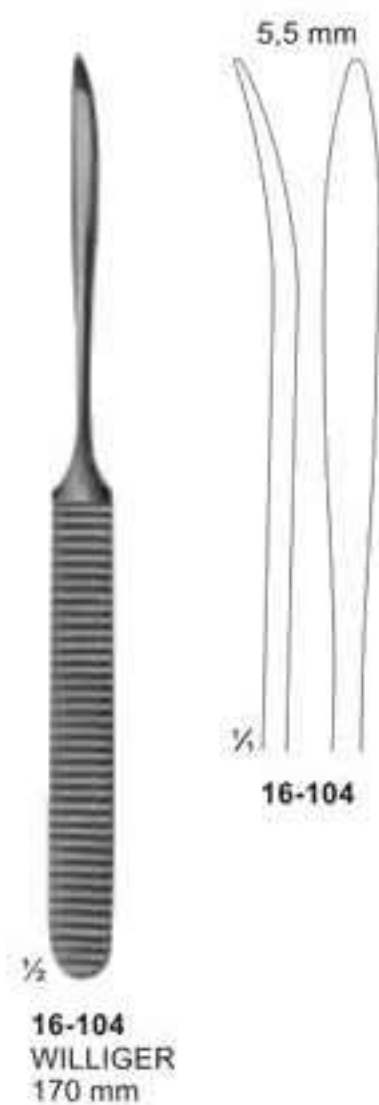
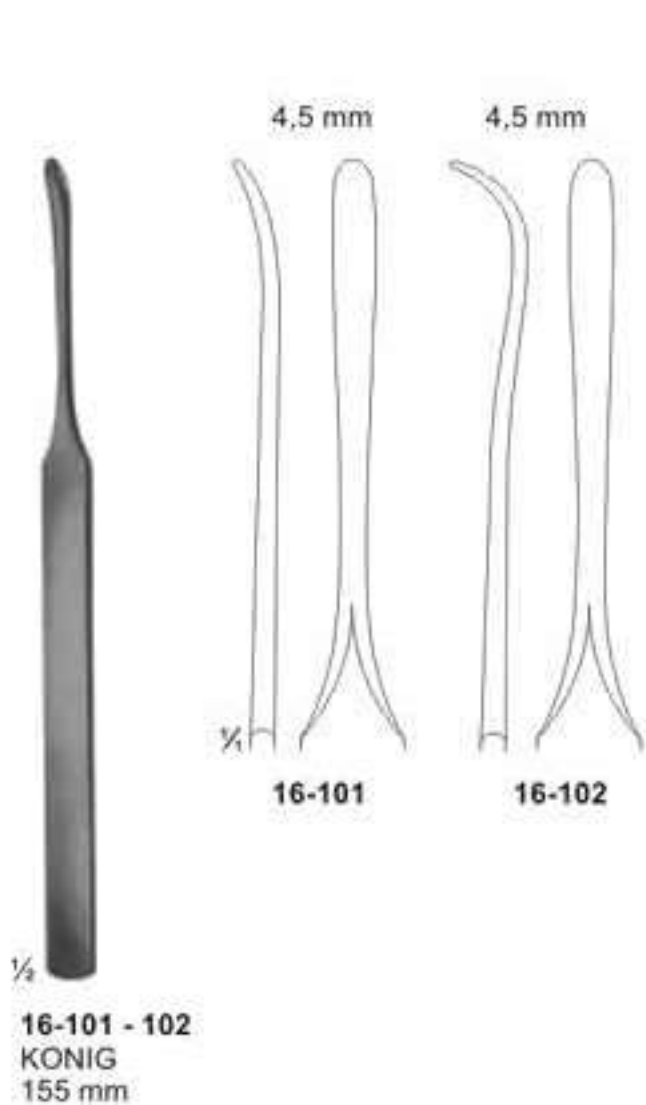

## Bone Levers



# Raspatories



**16-114**  
PARTSCH  
150 mm



**16-116**  
PARTSCH mod. LANGE  
145 mm



**16-117**  
MC KENTY  
155 mm

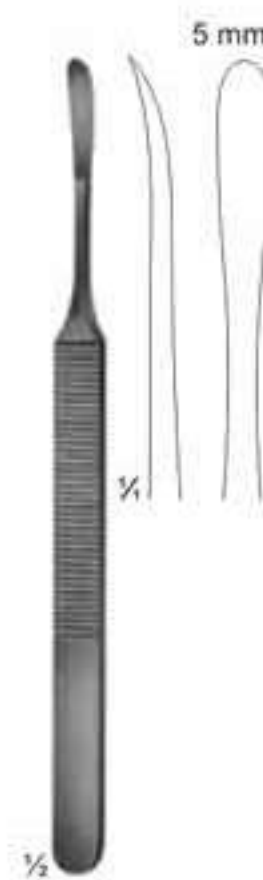

**16-118**  
KOENIG  
155 mm

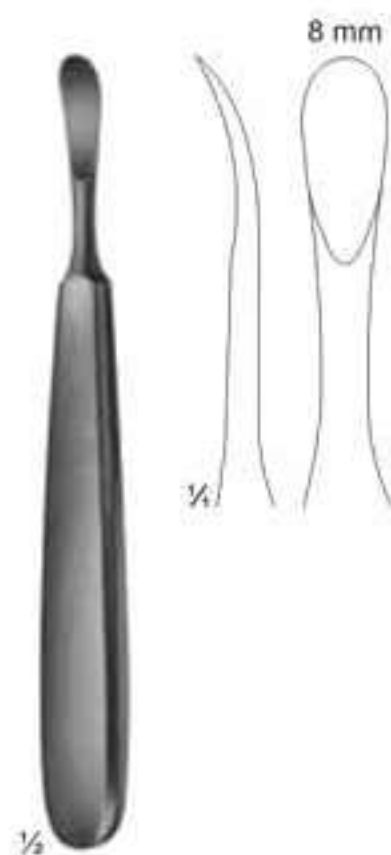

**16-119**  
TRELAT  
150 mm

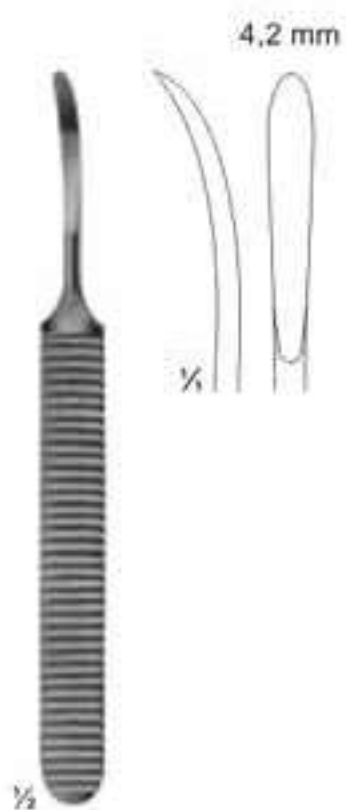

**16-120**  
WILLIGER  
140 mm

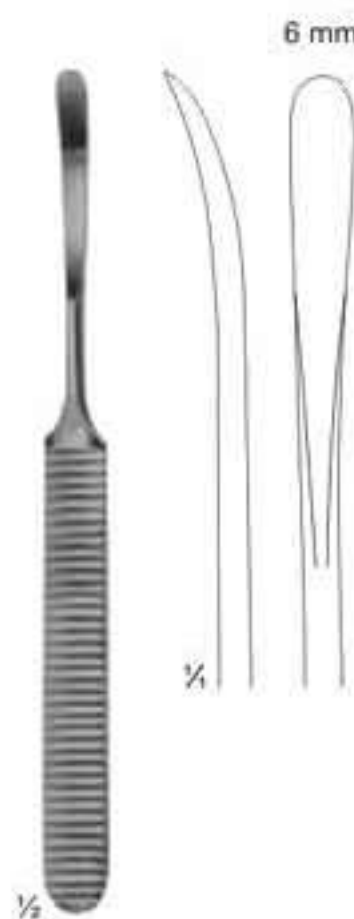

**16-121**  
WILLIGER  
160 mm

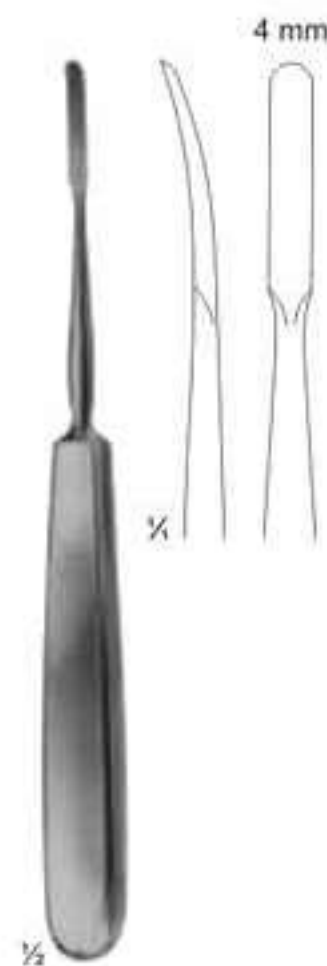

**16-122**  
JOSEPH  
170 mm

## Bone File and Rasps

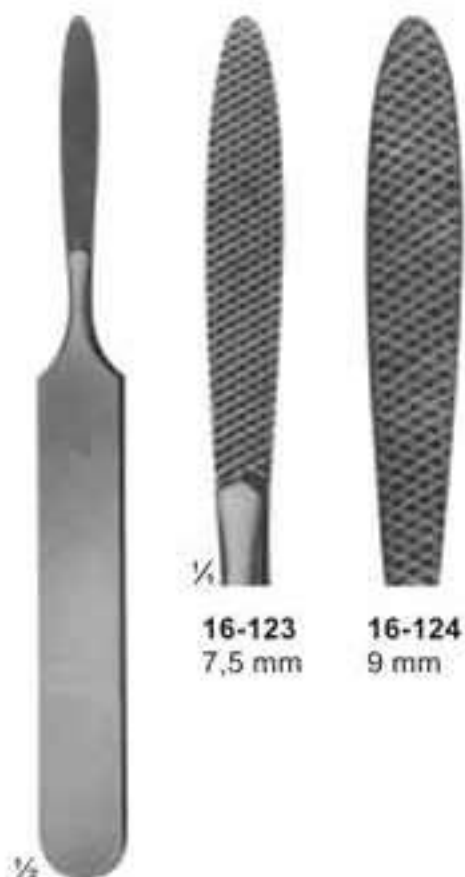

16-123  
7,5 mm

16-124  
9 mm

16-123  
JOSEPH  
fine, chequered

16-124  
coarse, chequered  
165 mm

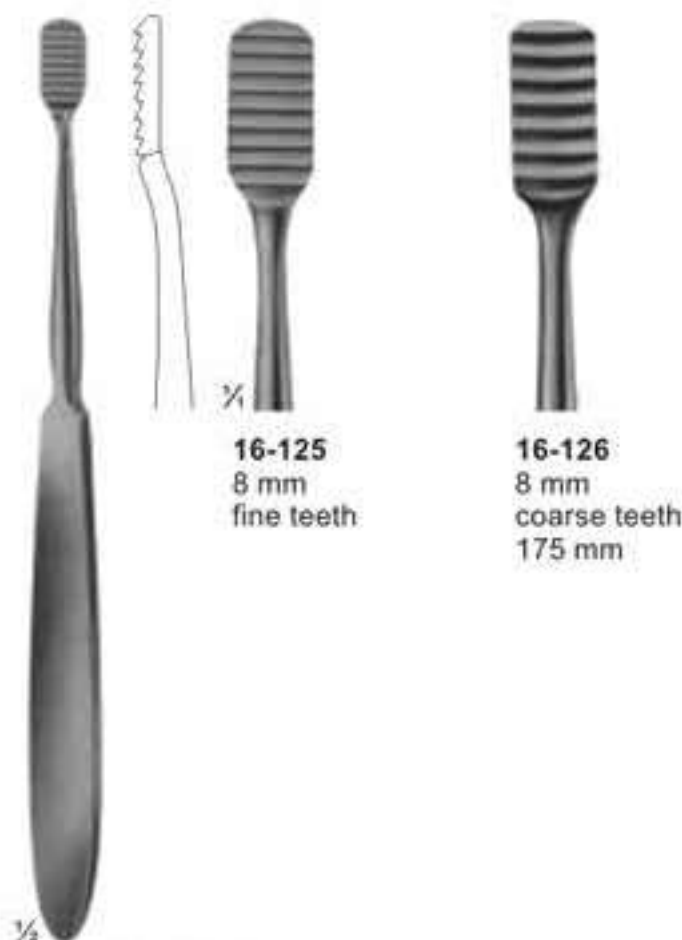

16-125  
8 mm  
fine teeth

16-126  
8 mm  
coarse teeth  
175 mm

16-125 - 16-126  
LEWIS



16-128  
9 mm

16-127  
MALTZ  
down stroke  
180 mm

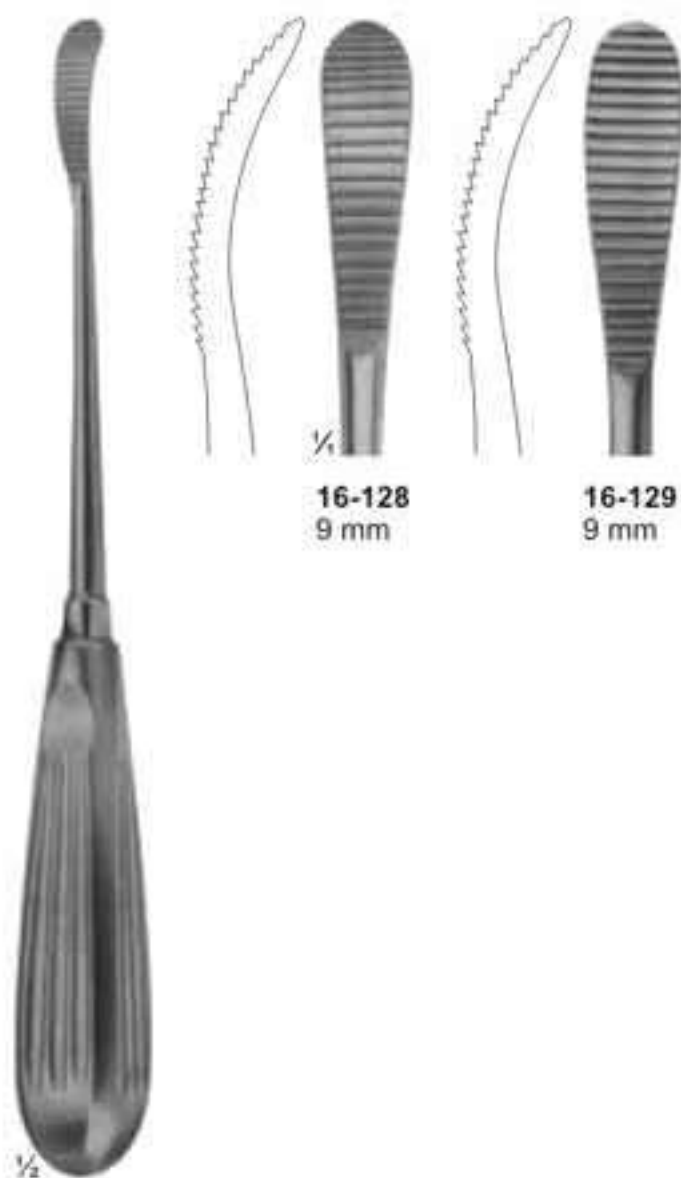

16-128  
9 mm

16-129  
9 mm

16-128 - 16-129  
AUFRICHT  
up stroke  
16-129  
down stroke  
220 mm



16-130  
6,5 mm

16-130  
GALLAHER  
190 mm

## Bone Currettes



**16-131**  
JACOBSON  
140 mm



**16-132**  
MARTINI  
140 mm



**16-133**  
MARTINI  
140 mm



**16-134**  
WILLIGER  
145 mm



**16-135**  
JANSEN  
160 mm



**16-136**  
BARTH  
180 mm



**16-137**  
VOLKMANN  
130 mm



**16-138**  
VOLKMANN  
145 mm



**16-139**  
VOLKMANN  
170 mm

**Mallets** Weights refer to the heads of the mallets  
**Hammer** Die Gewichtsangaben beziehen sich auf den Kopf des jeweiligen Hammers



∅ 20 mm

½

**17-101**  
MEAD  
185 g  
with interchangeable  
plastic disks  
190 mm  
**17-102**  
pair of spare disks



∅ 25 mm

½

**17-103**  
140 g  
with interchangeable  
plastic disks  
185 mm  
**17-104**  
pair of spare disks



∅ 30 mm

½

**17-105**  
COTTLE  
140 g  
1 Side Flat  
1 Side convex  
185 mm



∅ 22 mm

½

**17-106**  
165 g  
lead filled head  
190 mm

## Osteotomes, Chisels and Gouges



**17-107**  
**MANNERFELT**  
Gouge  
155 mm

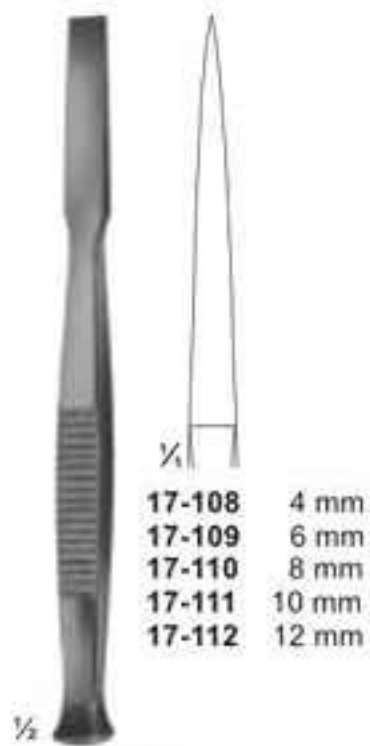

**17-108 - 112**  
**Osteotomes**  
140 mm

**17-108** 4 mm  
**17-109** 6 mm  
**17-110** 8 mm  
**17-111** 10 mm  
**17-112** 12 mm

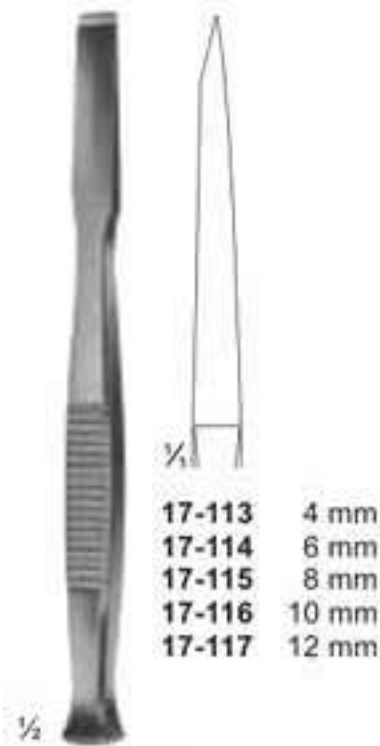

**17-113 - 117**  
**Chisels**  
140 mm

**17-113** 4 mm  
**17-114** 6 mm  
**17-115** 8 mm  
**17-116** 10 mm  
**17-117** 12 mm

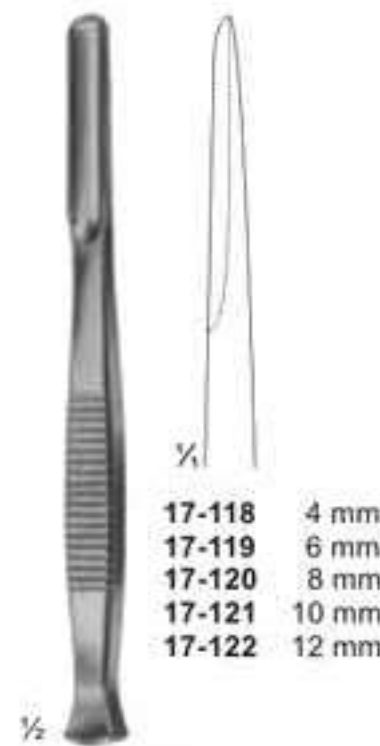

**17-118 - 122**  
**Gouges**  
140 mm

**17-118** 4 mm  
**17-119** 6 mm  
**17-120** 8 mm  
**17-121** 10 mm  
**17-122** 12 mm

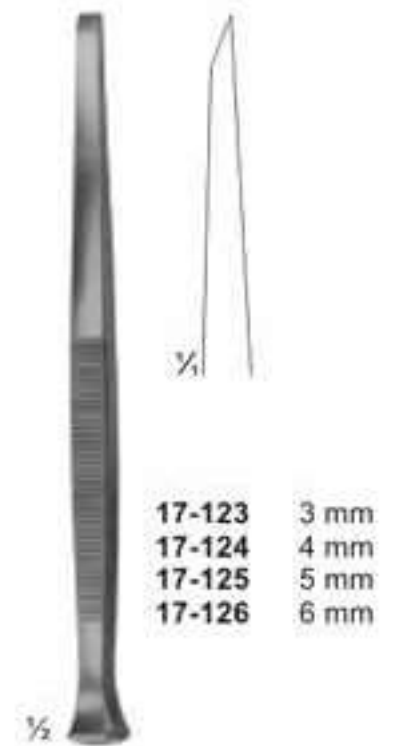

**PARTSCH**  
**17-123 - 126**  
**Chisels**  
140 mm

**17-123** 3 mm  
**17-124** 4 mm  
**17-125** 5 mm  
**17-126** 6 mm

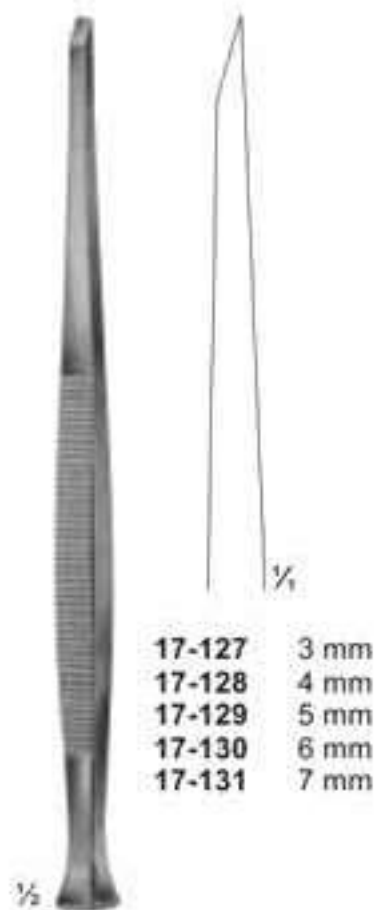

**PARTSCH**  
**17-127 - 131**  
**Chisels**  
170 mm

**17-127** 3 mm  
**17-128** 4 mm  
**17-129** 5 mm  
**17-130** 6 mm  
**17-131** 7 mm

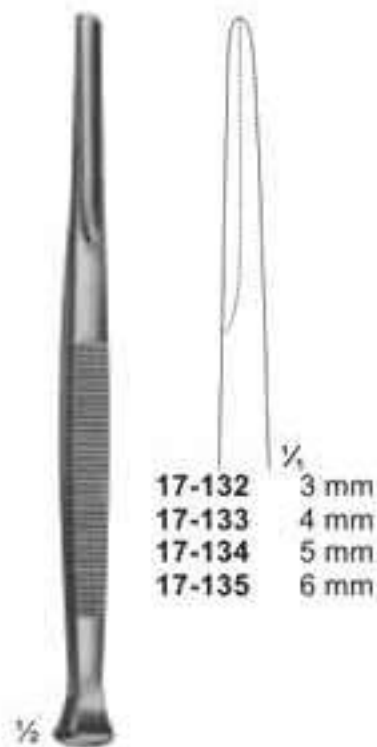

**PARTSCH**  
**17-132 - 135**  
**Gouges**  
140 mm

**17-132** 3 mm  
**17-133** 4 mm  
**17-134** 5 mm  
**17-135** 6 mm



**PARTSCH**  
**17-136 - 140**  
**Gouges**  
170 mm

**17-136** 3 mm  
**17-137** 4 mm  
**17-138** 5 mm  
**17-139** 6 mm  
**17-140** 7 mm



**LUCAS**  
**17-141 - 142**  
**Chisels**  
160 mm

**17-141** 4 mm  
**17-142** 6 mm



**LUCAS**  
**17-143 - 144**  
**Gouges**  
160 mm

**17-143** 3 mm  
**17-144** 5 mm



## Reposition Forceps, Bone Holding Forceps



**17-145**  
Patella forceps  
185 mm



**17-146**  
Forceps with  
ratchet fixation  
140 mm



**17-147**  
Forceps with  
thread fixation  
170 mm



**17-148**  
Forceps with  
thread fixation  
235 mm

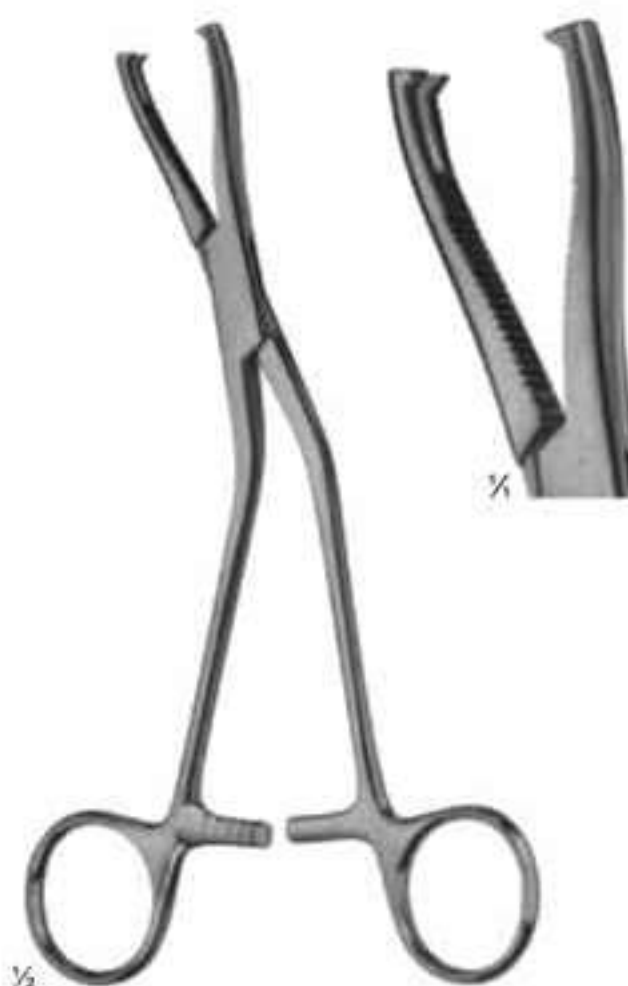

**17-149**  
DINGMANN  
185 mm

## Bone Holding Forceps & Bone Clamps



# Bone Rongeurs



**17-158**  
LUER  
150 mm



**17-159**  
LUER  
155 mm



**17-160**  
BLUMENTHAL  
155 mm



**17-161**  
BLUMENTHAL  
150 mm



**17-162 - 163**  
JANSEN  
175 mm



**17-164**  
BANE-HARTMANN  
175 mm

Bone Rongeurs



17-165  
STILLE  
235 mm



17-166  
LEKSELL-STILLE  
240mm



17-167  
STILLE-RUSKIN  
240mm

## Bone Cutting Forceps



**17-168**  
LISTON  
curved on flat  
240 mm



**17-169**  
LISTON  
straight  
280 mm

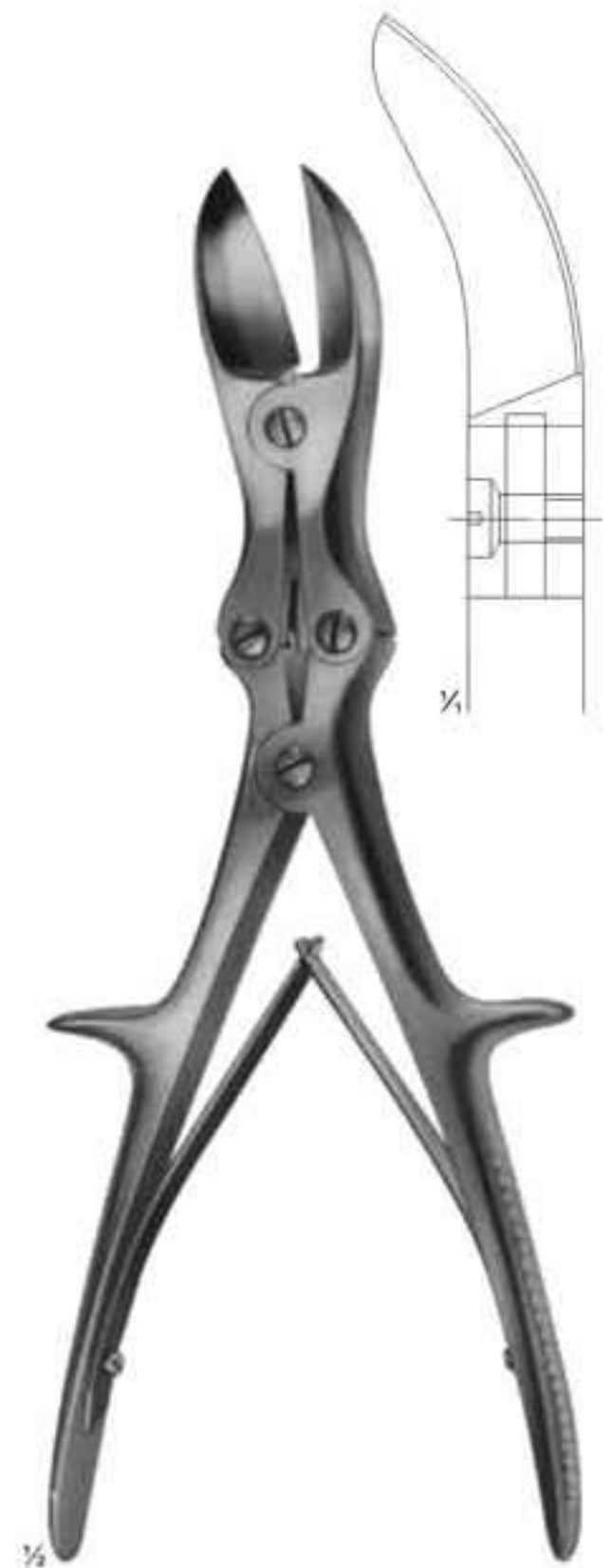

**17-170**  
LISTON  
curved on flat  
280 mm

# Wire Extension

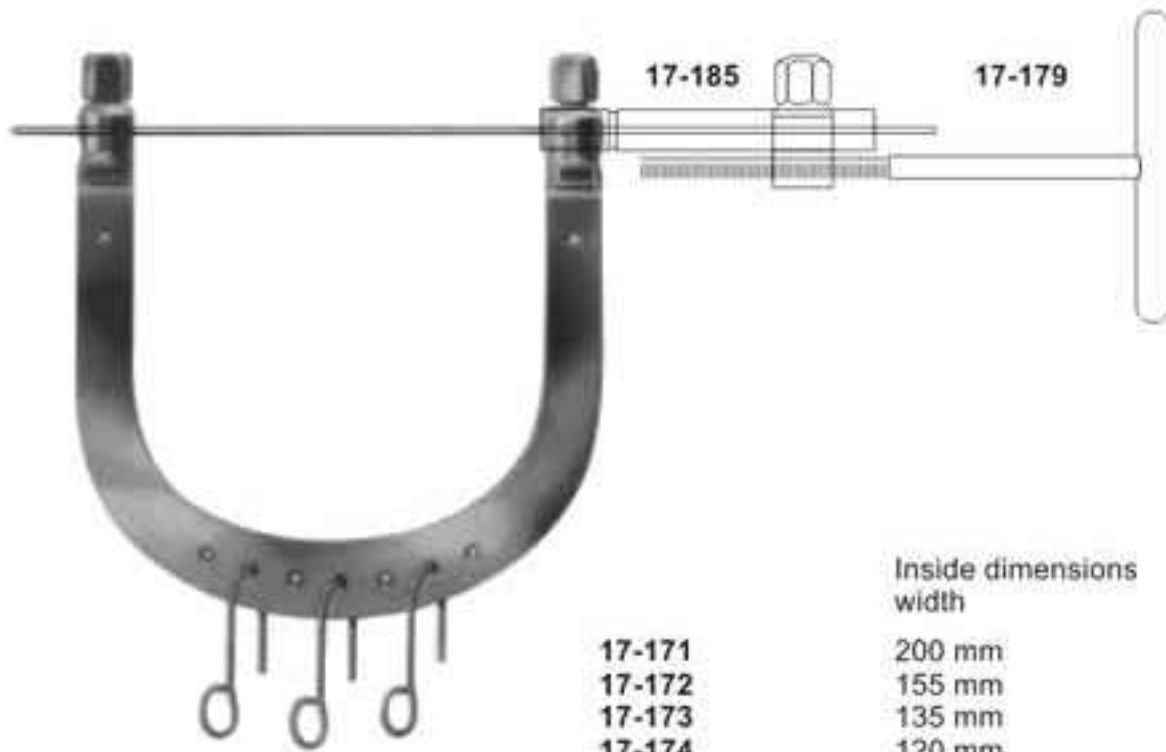

**17-171 - 17-177**  
KIRSCHNER  
Wire traction bows,  
to be used with  
KIRSCHNER-wires  
up to 2.5 mm diam.,  
With 3 hooks,  
stainless steel

	Inside dimensions width	depth	
17-171	200 mm	155 mm	for the hip
17-172	155 mm	155 mm	for the femur
17-173	135 mm	130 mm	for the knee
17-174	120 mm	120 mm	for the knee
17-175	105 mm	100 mm	for the knee
17-176	95 mm	110 mm	for the calcaneus
17-177	95 mm	70 mm	for the arm and elbow



**17-178**  
Wrench, double - ended,  
for wire traction bows



**17-179**  
Wire tightener, with  
clamping jaws



17-182	max. 105 mm
17-183	max. 160 mm
17-184	max. 200 mm
17-182	80-95 mm
17-183	90-120 mm
17-184	140-170 mm
diam upto	
17-182	1,6 mm
17-183	2,0 mm
17-184	2,5 mm

**17-182 - 17-184**  
KIRSCHNER  
Wire traction bows, modified,  
adjustable in width, holds wire  
securely, with 1 hook



**17-180**  
Traction hook only,  
large size



**17-181**  
Traction hook only,  
small size



**17-185**  
Fixation clamp, to secure clamping  
jaws of 17-179 stainless steel

# Cerclage Instruments

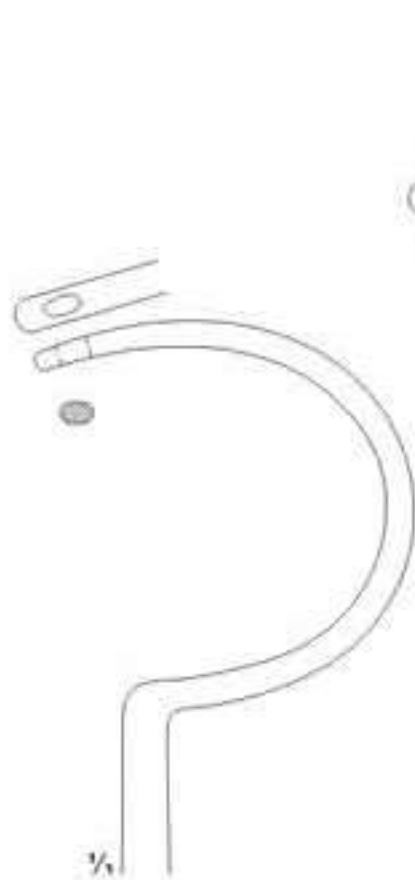

17-186  
275 mm

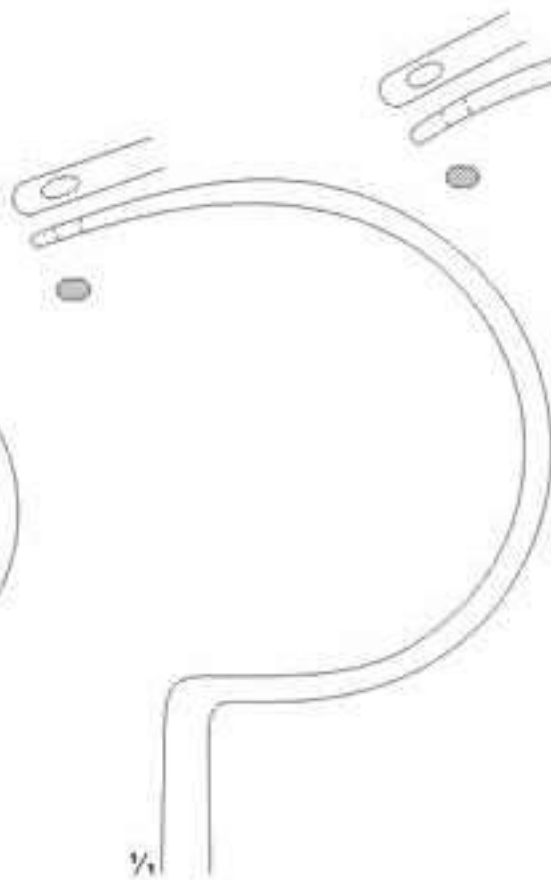

17-187  
285 mm

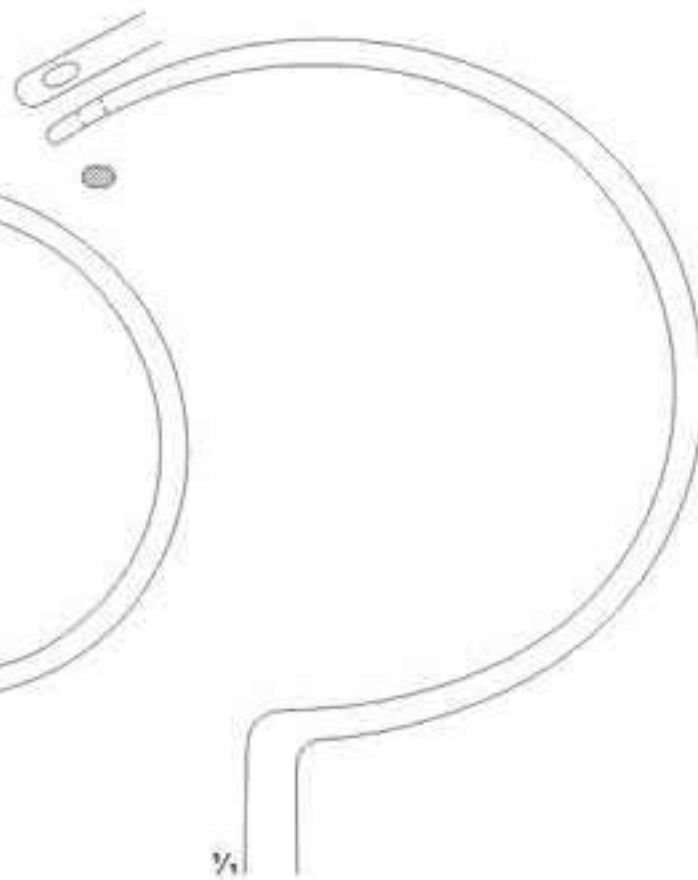

17-188  
305 mm



17-186 - 17-188  
DEMEL  
Wire guides

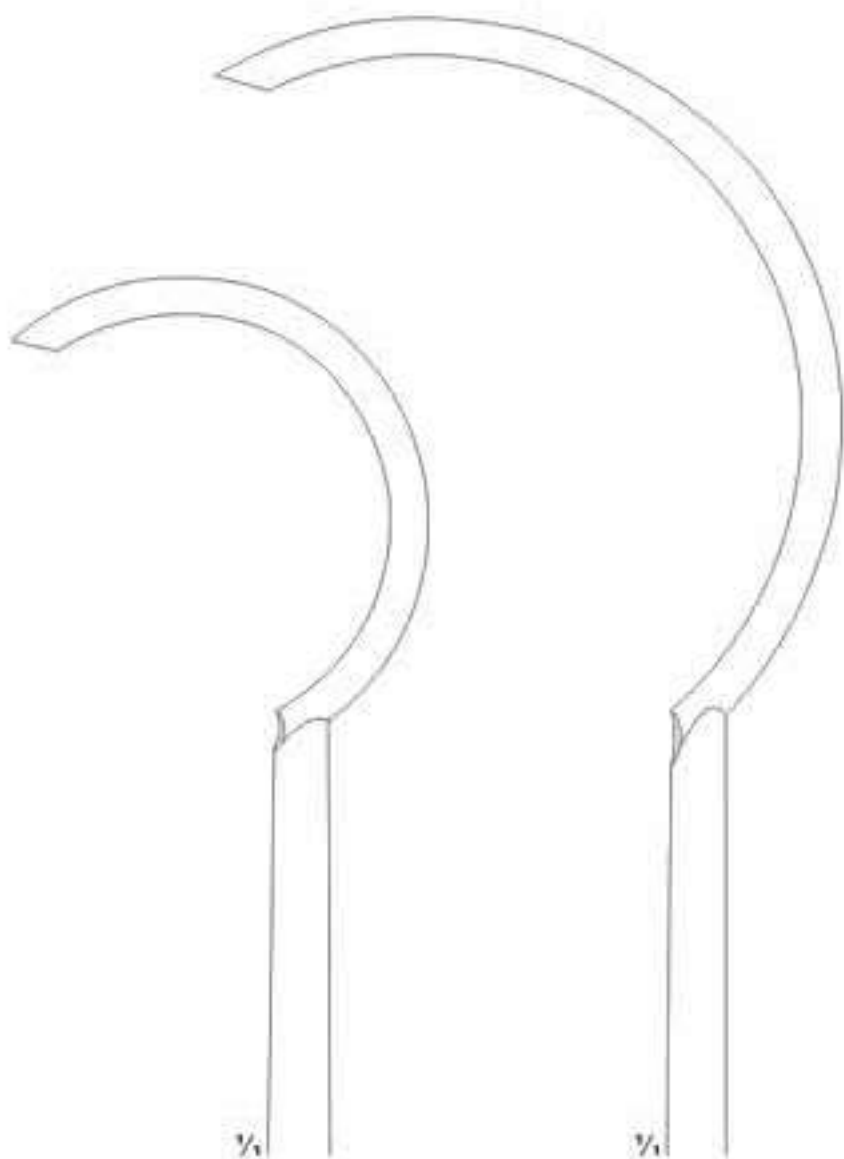

17-189  
240 mm



17-190  
270 mm



17-191  
225 mm

**Wire Holding forceps, Wire Tightening Pliers,  
Flat-nosed Pliers DUROGRIP with Hard Metal  
Inserts**



**17-192**  
DUROGRIP  
Holding forceps for cerclage  
wire, with lateral jaws to avoid  
wire slipping off  
170 mm



**17-193**  
DUROGRIP  
Wire, tightening pliers,  
Ligature pliers  
150 mm



**17-194**  
DUROGRIP  
Wire, tightening pliers,  
Ligature pliers  
150 mm



**17-195**  
with serrated jaws  
140 mm



**17-196**  
one jaw smooth,  
one jaw serrated  
140 mm



**17-197**  
with serrated jaws  
**17-198**  
with longitudinal and  
transversal grooves  
170 mm



**17-199**  
190 mm



Wire Holding forceps, Flat-nosed Pliers,  
Pliers for bending and cutting wires



17-200  
130 mm

17-201  
180 mm

17-200 - 17-201  
Extraction pliers  
for boring wires



17-202  
Flat-nosed pliers,  
parallel  
185 mm

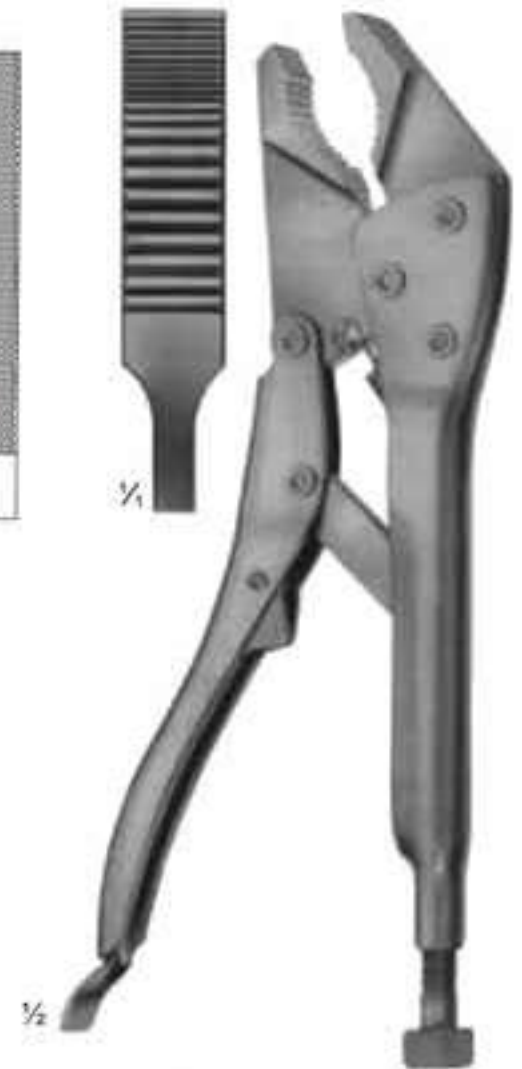

17-203  
Vise grip  
200 mm

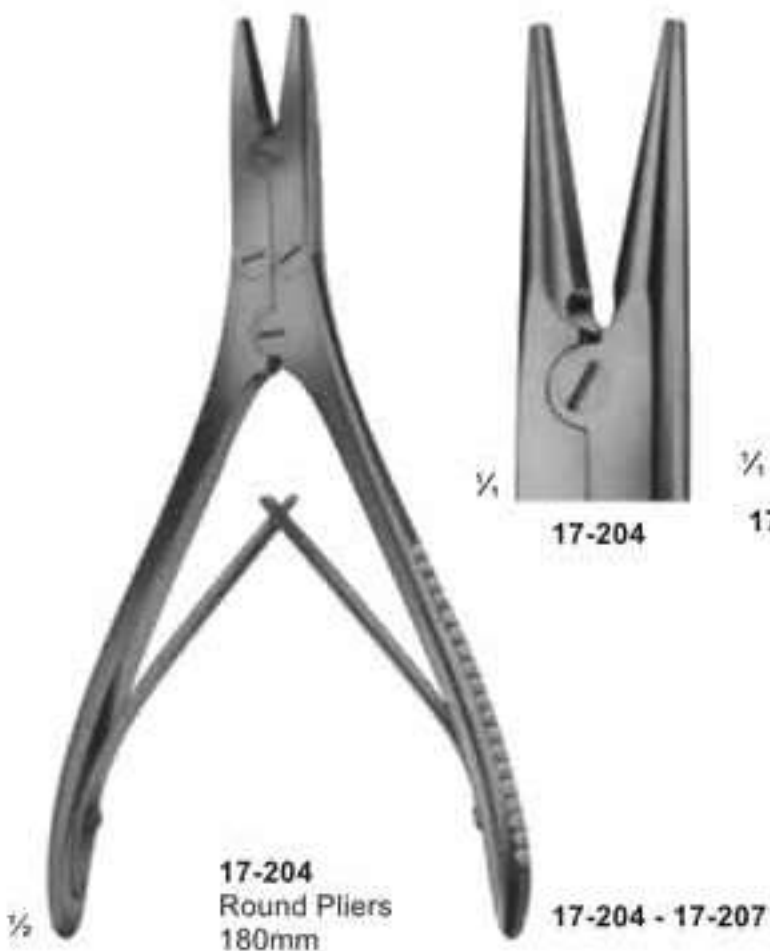

17-204  
Round Pliers  
180mm

17-204 - 17-207

17-205 145 mm  
17-206 180 mm  
17-207 180 mm  
Extraction pliers for wires



17-208  
Bending pliers  
for wires up to  
1.8 mm diam.

# Wire Cutters and wire Cutting Scissors DUROTIP with Carbide Cutting Edges



**17-209**  
ANGLE  
130 mm

for soft wire  
up to diam.  
for hard wire  
up to diam.

0,5 mm  
0,3 mm



**17-210**  
DUROTIP  
ANGLE  
130 mm

0,6 mm  
0,4 mm

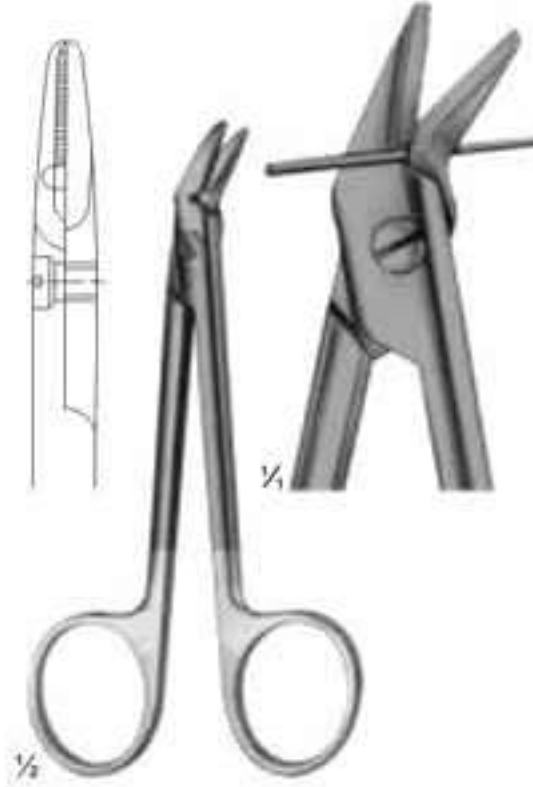

**17-211**  
120 mm

**17-212**  
DUROTIP  
120 mm

for soft wire  
up to diam.  
for hard wire  
up to diam.

1,2 mm  
0,8 mm



**17-213**  
HARVEY  
125 mm

0,4 mm  
0,3 mm



**17-214**  
150 mm

for soft wire  
up to diam  
for hard wire  
up to diam

1,5 mm  
1,0 mm



**17-215**  
160 mm

1,5 mm  
1,2 mm



**17-216**  
140 mm  
DUROTIP  
1,5 mm

1,0 mm

## Wire Cutting Pliers, Lateral Cutting Action



**17-217**  
180 mm

for soft wire  
up to diam. 2,0 mm  
For hard wire 1,5 mm  
up to diam  
specially hardened  
cutting edges, front  
and lateral cutting  
action



**17-218**  
REILL  
175 mm

for soft wire  
up to diam. 2,0 mm  
For hard wire 1,6 mm  
up to diam  
specially hardened  
cutting edges, for  
cutting off wires close  
to the bone



**DUROTIP**

**17-219**  
235 mm

for soft wire  
up to diam. 3,0 mm  
For hard wire 2,2 mm  
up to diam

# Wire Cutting Pliers, Lateral and Front Cutting Action



**17-220**  
240 mm

for soft wire up to diam. 2,0 mm  
For hard wire up to diam. 1,6 mm



**17-221**  
145 mm

for soft wire up to diam. 1,5 mm  
For hard wire up to diam. 1,0 mm



**17-222**  
145 mm

for soft wire up to diam. 2,0 mm  
For hard wire up to diam. 1,5 mm



**17-223**  
220 mm

for soft wire up to diam. 3,5 mm  
For hard wire up to diam. 2,5 mm

## Wire Cutting Pliers



**17-224**  
320 mm

for soft wire  
up to diam. 3,0 mm  
For hard wire  
up to diam 3,0 mm



Cutter for cutting off  
KIRSCHNER wires,  
Tibia head screws,  
bolts, pins, up to 3 mm diam.



DUROTIP

**17-225**  
Cutter for cutting off  
KIRSCHNER wires,  
Tibia head screws,  
bolts, pins, up to 6 mm diam.  
470 mm

## Finger Nail Instruments

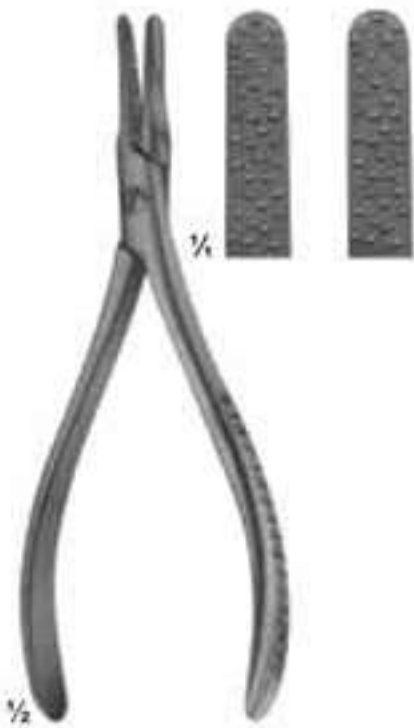

**17-226**  
Nail extracting  
forceps  
135 mm



**17-227**  
Nail extracting  
forceps  
145 mm



**17-228**  
Finger nail drill  
with 3 drill points

Drill points only

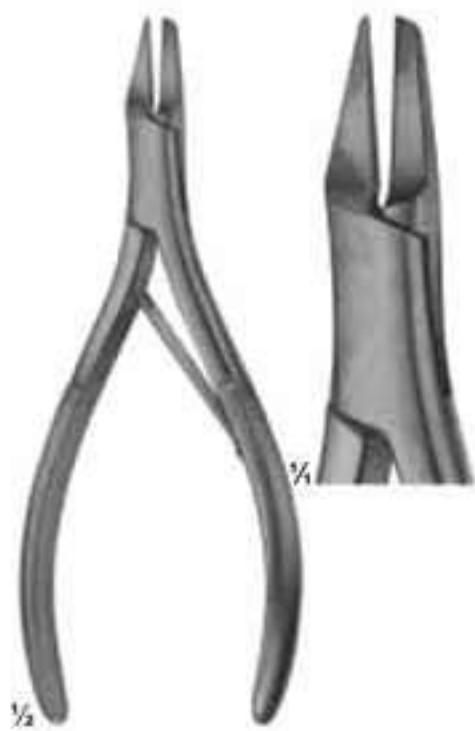

**17-231**  
Nail splitting  
forceps  
135 mm



**17-232**  
SYSTRUNK  
Scissors, for splitting  
finger nails  
130 mm



**17-233**  
Finger ring saw  
150 mm

Spare blade  
17-234

# Plaster Shears



17-235  
STILLE-AESULAP  
260 mm



17-236  
STILLE-AESULAP  
360 mm

## Plaster Spreader, Plaster Breakers



17-237  
HENING  
270 mm



17-238  
MOD.USA  
230 mm



17-239  
290 mm



with removable jaws



17-240 - 17-241  
WOLFF  
17-240 180 mm  
17-241 240 mm  
plaster breakers



## Vacuum Currettes for Aspiration Lipectomy, Suction Instruments

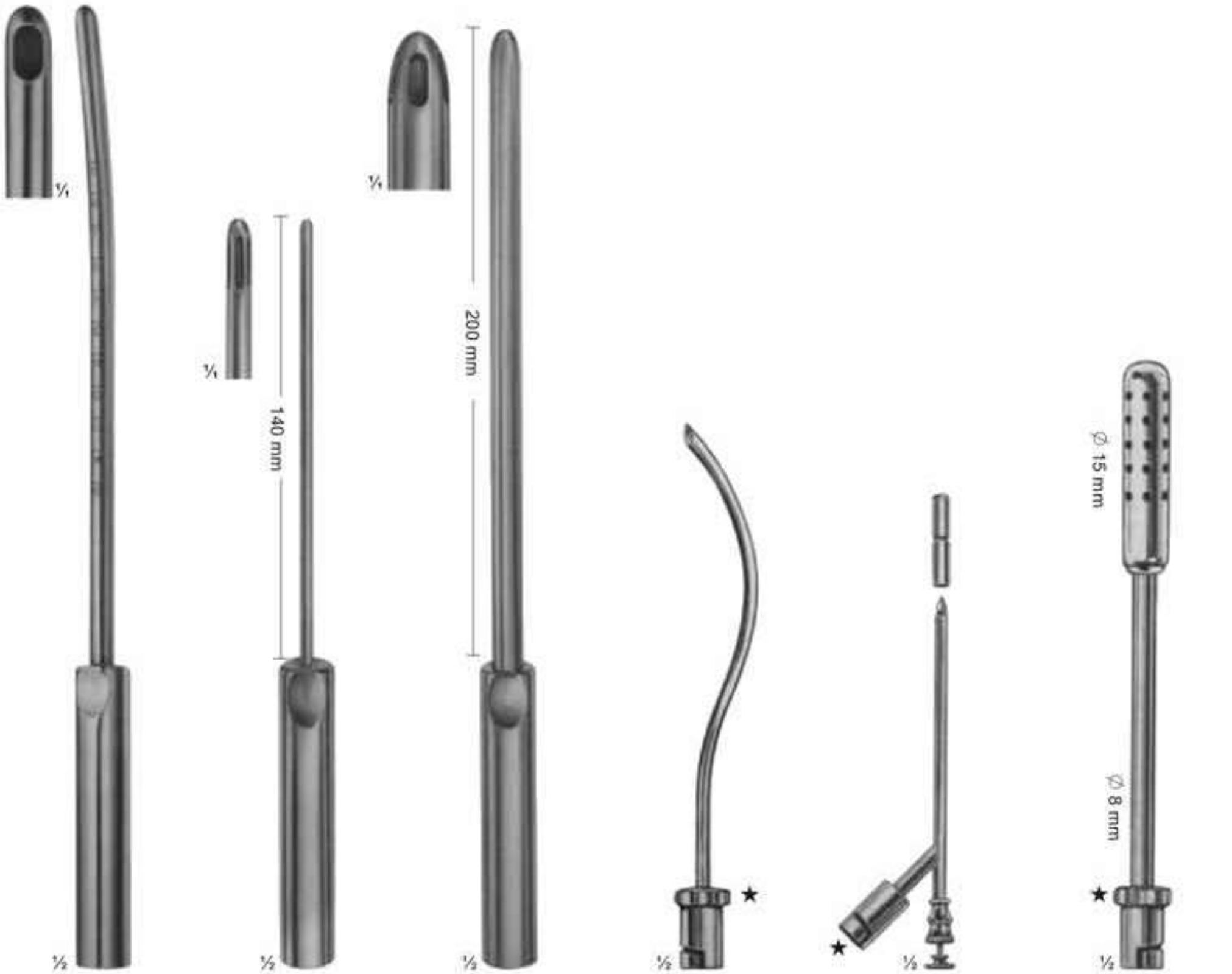

**18-101 - 18-106**  
BIEMER  
18-101  $\varnothing$  4 mm  
18-102  $\varnothing$  6 mm  
18-103  $\varnothing$  8 mm  
18-104  $\varnothing$  10 mm  
18-105  $\varnothing$  12 mm  
18-106  $\varnothing$  14 mm  
Currettes for aspiration lipectomy, graduated, slightly curved

**18-107 - 18-108**  
BIEMER  
18-107  $\varnothing$  4 mm  
18-108  $\varnothing$  6 mm  
Currettes for aspiration lipectomy, with three apertures, slightly curved malleable

**18-109 - 18-111**  
BIEMER  
18-109  $\varnothing$  8 mm  
18-110  $\varnothing$  10 mm  
18-111  $\varnothing$  12 mm  
Currettes for aspiration lipectomy, with three apertures, slightly curved malleable

**18-112**  
For aspirating fluid from the excretory ducts of large glands and for keeping the operating area clear  
170 mm

**18-113**  
Trocar  
For puncturing  
150 mm

**18-114**  
For clearing large quantities of fluid  
190 mm

## Suction Instruments

**18-115** 150mm  
Suction handle, with vacuum regulator and finger cut-off, brass, mirror-finish chromium-plated



olive  
Ø 9 mm

**18-116** 170mm  
Suction handle, with hand regulation valve and quick-shutter, brass, mirror-finish chromium-plated



Both suction handles have bayonet fitting olive and can be used for the suction cannulae. Ø 9 mm



**18-117**  
Trocar  
For puncturing  
170 mm



**18-118**  
Hollow needle,  
sharp  
150 mm



**18-119**  
double curved  
For general  
surgery  
230 mm



**18-120**  
For tonsillectomy,  
oral and laryngeal  
operations  
190 mm



**18-121**  
For tonsillectomy,  
oral and laryngeal  
operations  
220 mm

★ With bayonet fitting to be used with suction handles (18-115 - 18-116)

# Suction Instruments

**18-122**  
WULLSTEIN  
Suction tube, conical, silver, olive  
with LUER hub  
160 mm



**18-123** 1.5 mm  
**18-124** 2.0 mm  
WULLSTEIN  
Suction tube, cylindrical, silver, with  
stylet olive with LUER hub  
160 mm



Usable length

YASARGIL usable length diam.		YASARGIL usable length diam.	
<b>18-125</b>	130 mm 1,5 mm	<b>18-133</b>	130 mm 2,5 mm
<b>18-126</b>	150 mm 1,5 mm	<b>18-134</b>	150 mm 2,5 mm
<b>18-127</b>	180 mm 1,5 mm	<b>18-135</b>	180 mm 2,5 mm
<b>18-128</b>	220 mm 1,5 mm	<b>18-136</b>	220 mm 2,5 mm
<b>18-129</b>	130 mm 2,0 mm	<b>18-137</b>	130 mm 3,5 mm
<b>18-130</b>	150 mm 2,0 mm	<b>18-138</b>	150 mm 3,5 mm
<b>18-131</b>	180 mm 2,0 mm	<b>18-139</b>	180 mm 3,5 mm
<b>18-132</b>	220 mm 2,0 mm	<b>18-140</b>	220 mm 3,5 mm
		<b>18-141</b>	180 mm 4,5 mm

olive  
Ø 6,5-9 mm  
with LUER hub

**18-142 - 18-144**  
LANDOLT  
150 MM  
diam Ø 3 mm

**18-142** 8 mm / curved  
**18-143** 11mm / curved  
**18-144** 15mm / curved



**18-145** 500 mm  
**18-146** 350 mm  
with rubber tip,  
with LUER hub

**18-147** 2.0 mm diam  
**18-148** 2.5 mm diam  
**18-149** 3.0 mm diam  
with finger cut-off,  
thumb piece 90° to  
curve, with LUER hub  
250 mm

olive  
Ø 6-9 mm  
1/2

# Combined Suction and Irrigation Cannulae, Coagulation Suction Cannulae



**18-151**  
YASARGIL  
LUER-LOCK cone  
200 mm

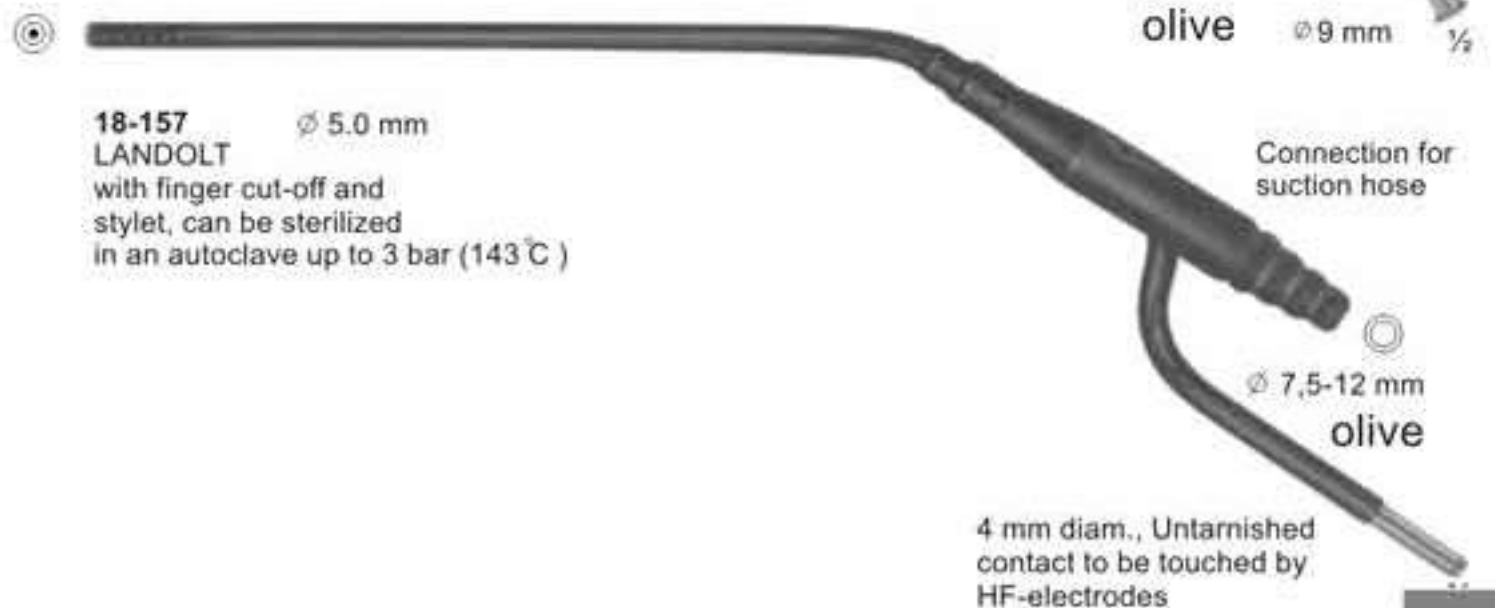

## Suction Instruments

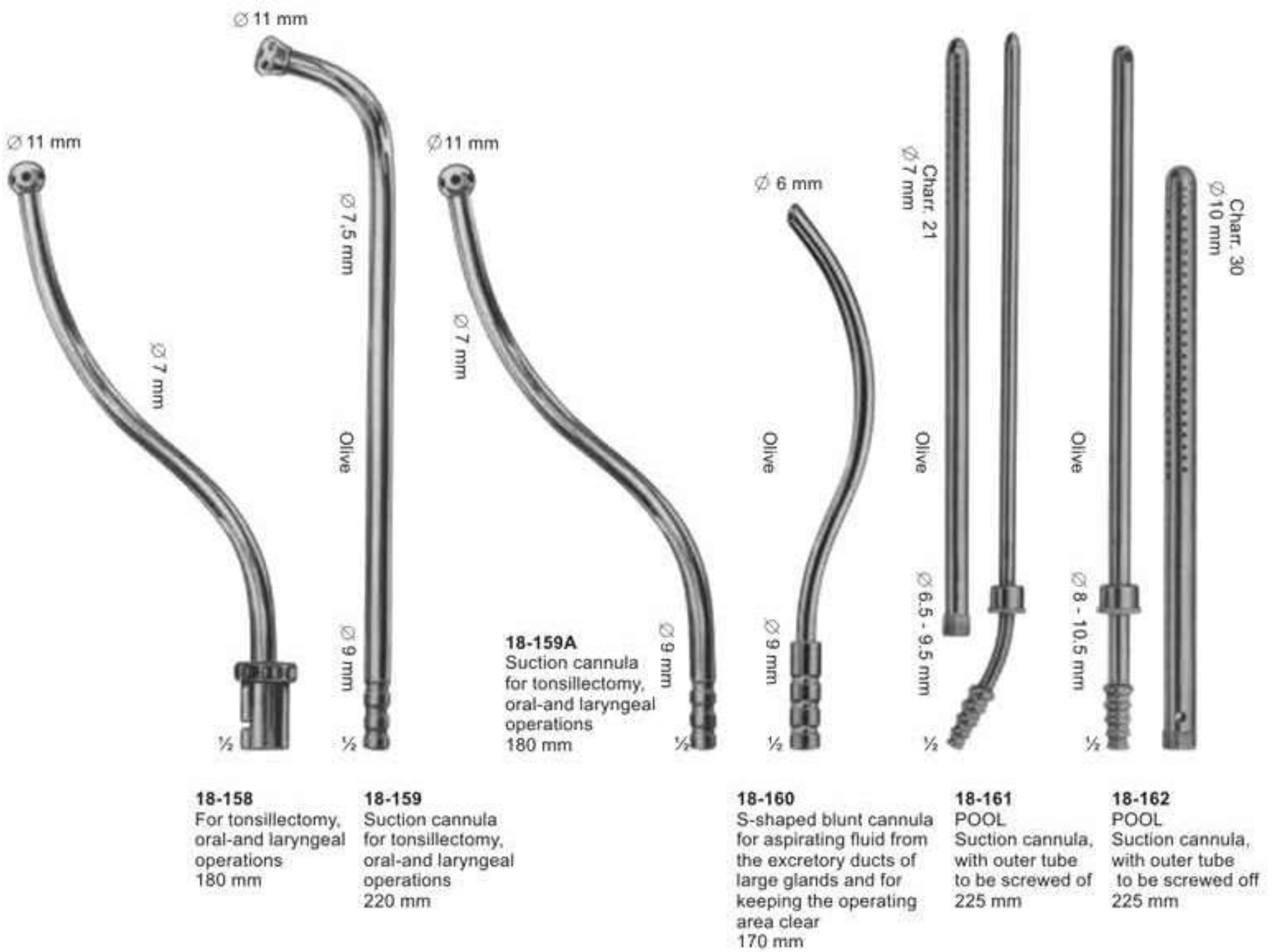

## Suction Instruments

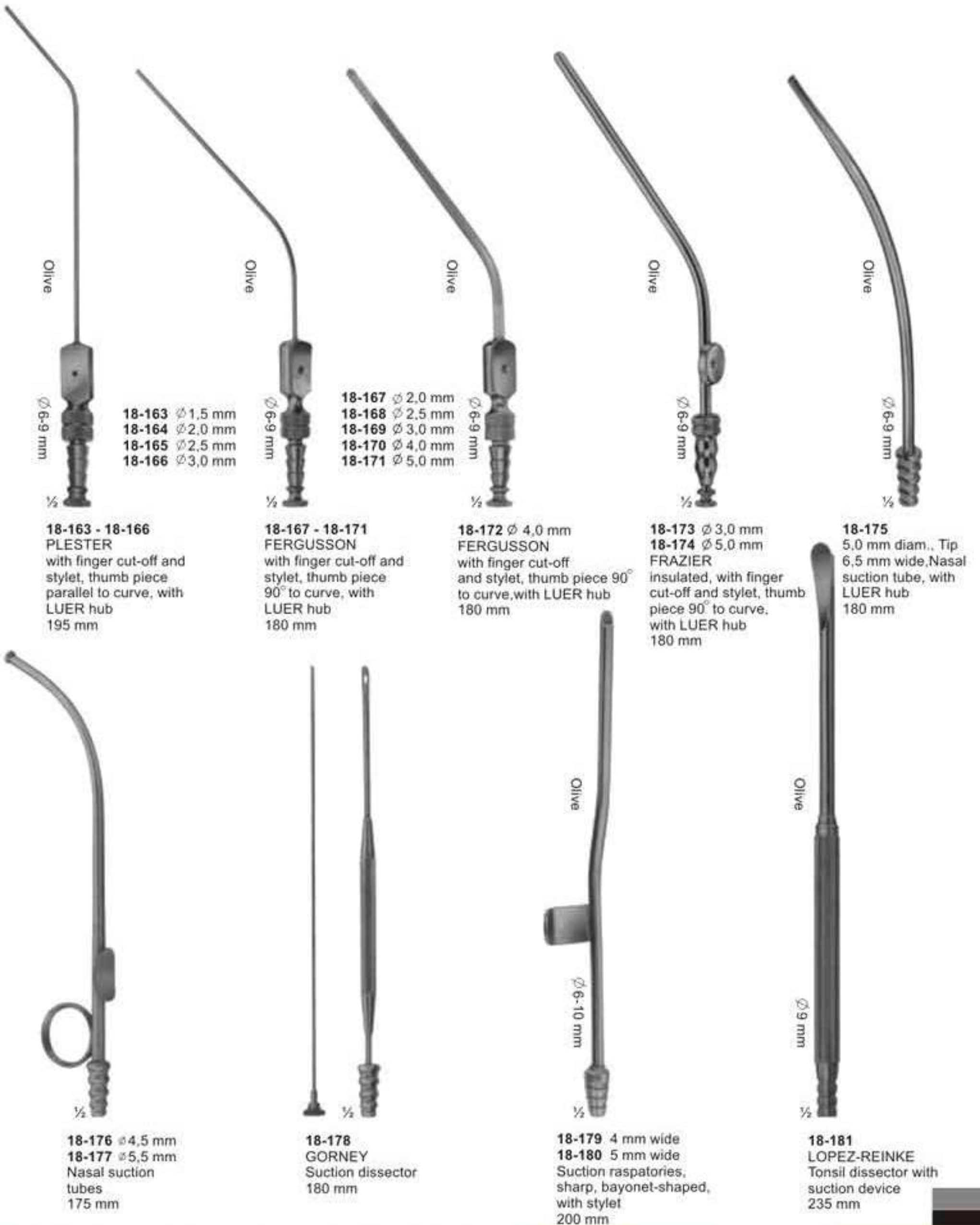

## Dissection Instruments



### 18-182

- 1- Blow pipe .
- 2- 3 PCS .scalpel.
- 3- Dissecting forcep 13 cm.
- 4- Grooved director with tounge tie 13 cm.
- 5- Triple chain hook.
- 6- Dressing scissors probe pointed 13 cm.
- 7- Probe double 13 cm.
- 8- Zipper case inside red velvet.



### 18-183

- 1- Probe Double 13 cm
- 2- 2 PCS. Scalpel S.S
- 3- Grooved Director With tongue Tie 13 cm
- 4- Mayo Hegar Needle Holder 13cm
- 5- Disscting Forcep 13 cm 1x2 Teeth
- 6- Dressing Forcep 13 CMS Serrated.
- 7- Dressing Scissor 13 cm S/B STR.
- 8- Dressing Scissor 13 cm S/B CVD.
- 9- Zipper Case Inside Red Velvet.

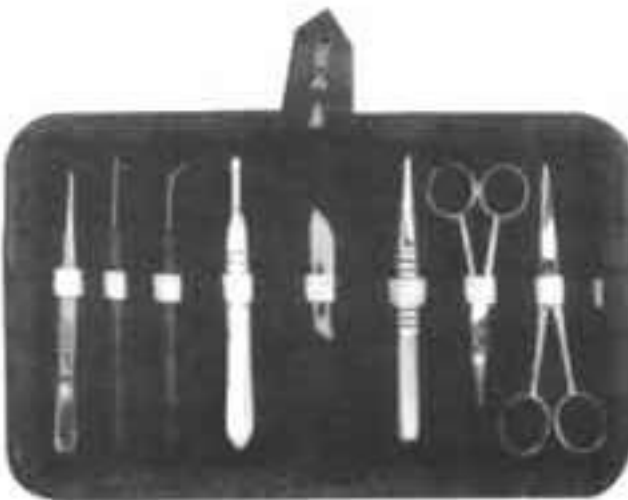

### 18-184

- 1- Dissecting Forcep 11.5 cm Sharp Point.
- 2- Iris Scissor
- 3- B.P Handle No. 4
- 4- Teasing Needle Sharp angular.
- 5- Blade No. 22
- 6- Thumb Forceps T.O.E 13 cm
- 7- Dissecting Scissor STR 11.5 cm
- 8- Dissecting Scissor STR 13 cm
- 9- Zipper case Inside Red Velvet

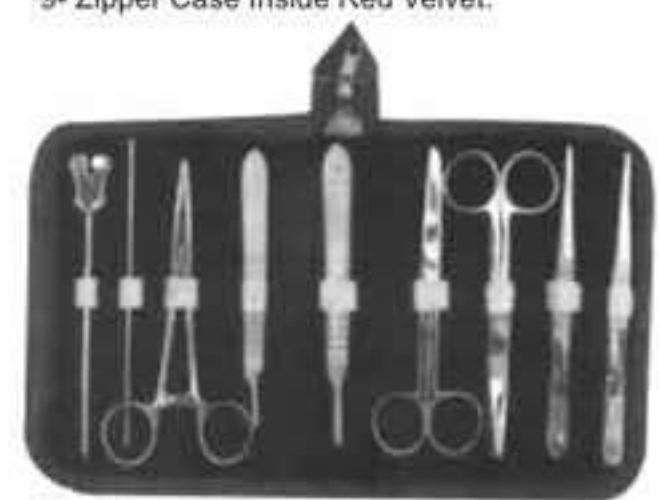

### 18-185

- 1- Grooved Director with Tongue Tie 14 cm
- 2- Probe Double 14cm
- 3- Mayo Hegar Needle Holder 14 cm
- 4- BP. Handle no.3
- 5- BP. Handle no.4
- 6- Dressing Scissor 14 cm S/B STR
- 7- Dressing Scissor 14 cm S/B CVD.
- 8- Dressing Forcep 1x2 Teeth 14 cm
- 9- Dressing Forcep Serrated 14 cm



### 18-186

- 1- Probe double 12.5 cm
- 2- Scalpel
- 3- B.P Handle No. 4
- 4- 6 PCS Blade 2 each no. 21, 22, 23
- 5- Dissecting Forcep 12.5 cm
- 6- Dissecting Forcep 11.5 cm sharp Point
- 7- Dissecting Scissor S/B STR 13 cm
- 8- Dissecting Scissor S/S STR 13 cm



### 18-187

- 1- Teasing Needle with Chuck CVD.
- 2- Huber Probe
- 3- Iris Scissor
- 4- Dissecting Forcep Fine 14 cm.
- 5- Dissecting Forcep Fine CVD. 12 cm
- 6- Operating Scissor with Probe 14 cm.
- 7- B.P. Handle no. 4

## Dissection Instruments



### 18-188

- 1- Probe with eye
- 2- Dissecting Forcep cvd fine 12 cm.
- 3- Iris Scissor
- 4- Operating Scissor S/B str 14 cm
- 5- Grooved Director and Tongue tie
- 6- Huber Probe
- 7- Triple Chain Hook
- 8- B.P Handle No. 4
- 9- B.P Handle No. 3
- 10- Teasing Needle with Chuck cvd.
- 11- Teasing Needle with Chuck str.
- 12- Dissecting Forceps Fine 14 cm.

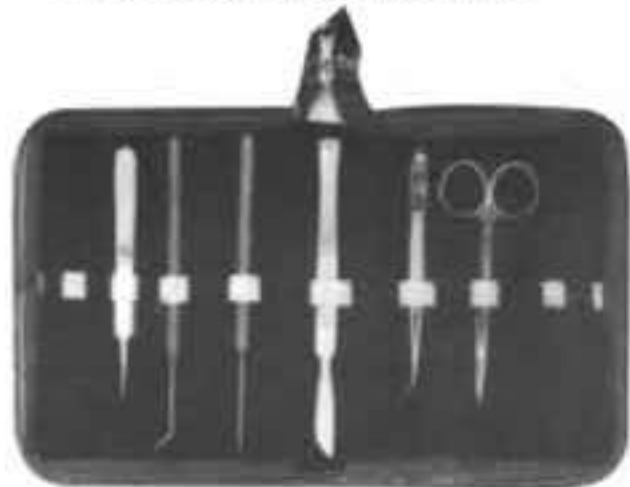

### 18-190

- 1- Iris Scissor STR
- 2- Dissecting Forceps CVD 12 cm.
- 3- Scapel
- 4- Teasing Needle STR wooden handle.
- 5- Teasing Needle CVD wooden handle.
- 6- Watchmaker fine point.



### 18-192

- 1- Probe double end.
- 2- Grooved director and lounge tie.
- 3- B.P handle no.4
- 4- Operating scissor STR S/b14cm.
- 5- Kelly forceps STR 14cm.
- 6- Dissecting forceps thumb 13cm.



### 18-189

- 1- Grooved Director and Tongue tie
- 2- Mayo Harg Needle Holder 14 cm
- 3- B.P Handle No. 4
- 4- Dissecting Forceps Thump 14 cm.
- 5- Operating Scissor S/B str 14 cm
- 6- Kelly Forcep STR 14 cm.
- 7- Probe Double end



### 18-191

- 1- Probe Double end
- 2- B.P Handle No. 4
- 3- Dissecting Forcep 1x2 Teeth 14 cm.
- 4- Operating Scissor S/B str 14 cm
- 5- Mayo Harg Needle Holder 14 cm
- 6- Kelly Forcep STR 14 cm.
- 7- Operating Scissor S/B CVD 14 cm
- 8- Grooved Director and Tongue tie
- 9- Dissecting Forceps Thumb 14 cm.

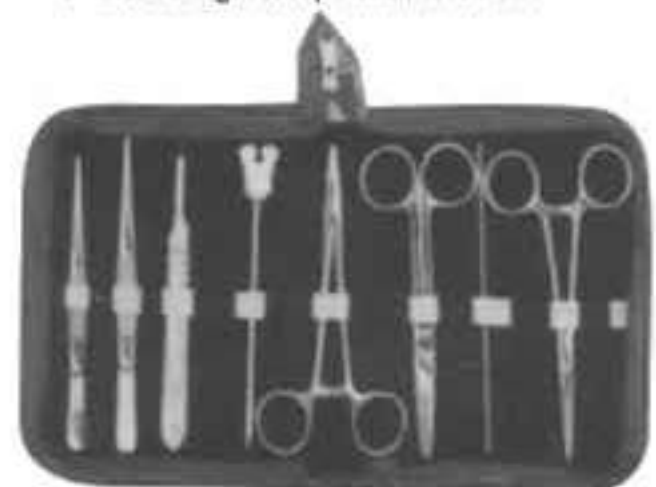

### 18-193

- 1- Dissecting Forceps Thumb 14 cm
- 2- Dissecting Forcep 1x2 Teeth 14 cm.
- 3- B.P Handle No. 3
- 4- Grooved Director and Tongue tie
- 5- Mayo Harg Needle Holder 14 cm
- 6- Operating Scissor S/B str 14 cm
- 7- Probe Double end
- 8- Kelly Forcep STR 14 cm.



## Dissection Instruments



### 18-194

- 1- Dissecting Forcep Fine 14cm.
- 2- Dissecting Forcep Fine CVD 12cm
- 3- Dissecting Forcep with Pin 14cm.
- 4- Watchmaker Fine point
- 5- Iris scissor STR
- 6- Iris scissor CVD
- 7- Teasing Needle holder
- 8- Teasing Needle STR.
- 9- B.P. Handle no. 3



### 18-195

- 1- Teasing Needle STR.
- 2- Grooved Director and Tongue Tie.
- 3- Teasing Needle CVD.
- 4- Dissecting Forcep with Pin 12 cm Fine
- 5- Operating Scissor S/B STR 14 cm
- 6- Triple Chain Hook
- 7- Probe with eye
- 8- Probe Double end
- 9- Probe and Hook
- 10- Dissecting Forcep Fine 14 cm
- 11- Iris Scissor
- 12- Huber Probe
- 13- B.P. Handle no.3
- 14- B.P. Handle no.4



### 18-196

- 1- Dissecting forcep fine STR with pin 12cm.
- 2- Iris scissor STR.
- 3- Probe with eye.
- 4- Probe and hook.
- 5- Operating scissor S/B STR 14cm
- 6- Triple chain hook.
- 7- B.P. handle no.4
- 8- Humber probe.
- 9- B.P.handle no.3
- 10- Teasing needle STR, plastic handle.
- 11- Teasing needle CVD plastic handle.
- 12- Grooved director and tongue tie.
- 13- Probe double end.



### 18-197

- 1- Dissecting Forceps Thumb 14 cm.
- 2- Dissecting Forcep 1x2 Teeth 14 cm.
- 3- B.P Handle No. 3
- 4- Grooved Director and Tongue tie
- 5- Mayo Herg Needle Holder 14 cm
- 6- Operating Scissor S/B str 14 cm
- 7- Probe Double end
- 7- Kelly Forcep STR 14 cm.

## Hospital Wares



**19-101 - 115**  
Schimmelbusch

Ø x H  
sizes in mm

<b>19-101</b>	80 x 80
<b>19-102</b>	105 x 120
<b>19-103</b>	140 x 140
<b>19-104</b>	160 x 120
<b>19-105</b>	160 x 150
<b>19-106</b>	190 x 150
<b>19-107</b>	190 x 190
<b>19-108</b>	240 x 160
<b>19-109</b>	240 x 240
<b>19-110</b>	290 x 160
<b>19-111</b>	290 x 240
<b>19-112</b>	340 x 160
<b>19-113</b>	340 x 340
<b>19-114</b>	390 x 190
<b>19-115</b>	390 x 290



**19-116**  
Box  
120 x 65 x 13mm  
(without Bulldog clamps,  
without silicone tape)



**19-117**  
Box with support  
120 x 65 x 13 mm  
(ohne Bulldogklemmen)



**19-118**  
Box with support for  
needle electrodes,  
without instruments



**19-119 - 121**  
50 x 25 x 4,5 mm  
**19-120**  
65 x 42 x 8 mm  
**19-121**  
75 x 25 x 4,5 mm



**19-122**  
Ø 65mm x 15mm

## Hospital Wares



19-123 - 131

	∅ x H
19-123	30 x 90 mm
19-124	50 x 100 mm
19-125	50 x 130 mm
19-126	50 x 175 mm
19-127	75 x 100 mm
19-128	75 x 130 mm
19-129	75 x 175 mm
19-130	100 x 175 mm
19-131	100 x 200 mm



19-141 - 142

- 19-141** Martin Sterilizing Forceps consisting of:  
1 Sterilizing Forceps, curved, 25 cm, without ratchet, with lid for jar  
1 jar with bottom plate (anti-tilt)
- 19-142** ditto, with 32 cm long Sterilizing Forceps



19-132 - 139

19-132	165 x 85 x 35 mm
19-133	200 x 100 x 35 mm
19-134	200 x 100 x 50 mm
19-135	230 x 130 x 50 mm
19-136	260 x 150 x 50 mm
19-137	270 x 235 x 50 mm
19-138	300 x 200 x 50 mm
19-139	325 x 275 x 50 mm



**19-140**  
205 x 105 x 35 mm

## Round Metal Boxes and Medicine Cups



19-143 - 148

	∅ x H
19-143	75 x 60 mm
19-144	75 x 75 mm
19-145	100 x 60 mm
19-146	100 x 100 mm
19-146A	125 x 80 mm
19-147	125 x 125 mm
19-148	150 x 150 mm



19-149  
25 cc

19-150  
50 cc



19-151  
20 cc  
Medicine Spoon



19-152  
∅ 75 x 12 mm  
Tablet Tray



19-153  
∅ 90 x 90 mm  
Metal Cup



19-154  
∅ 75 x 80 mm  
Sputum Cup



Kidney Dish



19-155 - 157

19-155	170 x 100 x 35 mm
19-156	250 x 140 x 40 mm
19-157	275 x 150 x 45 mm

## Hospital Wares



19-158 - 165

	∅ x H	
19-158	40 x 19 mm	0.05L
19-159	61 x 30 mm	0.07L
19-160	80 x 40 mm	0.14L
19-161	116 x 50 mm	0.35L
19-162	128 x 55 mm	0.45L
19-163	147 x 65 mm	0.70L
19-164	167 x 75 mm	1.10L
19-165	187 x 85 mm	1.60L



19-166 - 170

19-166	116 x 35 mm	0.30L
19-167	128 x 38 mm	0.40L
19-168	147 x 40 mm	0.50L
19-169	157 x 45 mm	0.75L
19-170	187 x 45 mm	1.00L



19-171  
∅ 110 x 28 mm 0.15L



19-172  
100 cc 0.1L



19-173 - 176  
19-173 0.25L  
19-174 0.50L  
19-175 1.00L  
19-176 2.00L



19-177  
235 x 190 x 40 mm



19-178  
∅ 220 x 70 mm

## Hospital Wares



**19-179**  
∅ 50 x 100 mm  
Powder Pot



**19-180**  
∅ 50 x 75 mm  
Methot With Lid



**19-181**  
∅ 50 x 75 mm  
Methot Without Lid



**19-182**



**19-183**



**19-184**



**19-185 - 186**

19-185 ∅ 235 mm  
19-186 ∅ 310 mm

## Needle Cases



**19-187**  
Sauerbruch  
210 x 125 x 17 mm



**19-188**  
Sauerbruch  
210 x 125 x 17 mm



**19-189**  
Instruments Tray



**19-190**  
150 x 95 x 13 mm



**19-191**  
150 x 95 x 13 mm



**19-192**  
150 x 95 x 13 mm



**19-193**  
Instruments Tray



**19-194**  
Instruments Tray



**19-195**  
150 x 95 x 11 mm

## Storing Cases



19-199 - 209

19-199	230 x 130 x 50	mm
19-200	260 x 150 x 50	mm
19-201	275 x 235 x 50	mm
19-202	300 x 200 x 50	mm
19-203	325 x 275 x 50	mm
19-204	420 x 175 x 50	mm
19-205	230 x 130 x 75	mm
19-206	260 x 150 x 75	mm
19-207	300 x 200 x 75	mm
19-208	325 x 275 x 75	mm
19-209	420 x 175 x 75	mm



**19-196**  
Deponette  
245 x 135 x 35mm



**19-197**  
Deponette  
245 x 135 x 50mm



**19-198**  
Deponette  
245 x 135 x 60mm



## Sterilizing Baskets / Trays



19-210 - 212

19-210	480 x 250 x 50	mm
19-211	520 x 250 x 75	mm
19-212	520 x 250 x 100	mm



19-219  
(60 x 30 x 15 cm)  
Nominal dimensions



19-213 - 218

19-213	240 x 240 x 50	mm
19-214	240 x 240 x 80	mm
19-215	240 x 240 x 100	mm
19-216	480 x 260 x 50	mm
19-217	520 x 260 x 80	mm
19-218	520 x 260 x 100	mm

## Scissors with Tungsten Carbide Inserts



**26-101**  
Standard.

14,5cm  
16,5cm  
18,5cm



**26-102**  
Standard.

14,5cm  
16,5cm  
18,5cm



**26-103**  
Standard.

14,5cm  
16,5cm  
18,5cm



**26-104**  
Standard.

14,5cm  
16,5cm  
18,5cm



**26-105**  
Standard.

14,5cm  
16,5cm  
18,5cm



**26-106**  
Standard.

14,5cm  
16,5cm  
18,5cm

## Scissors with Tungsten Carbide Inserts

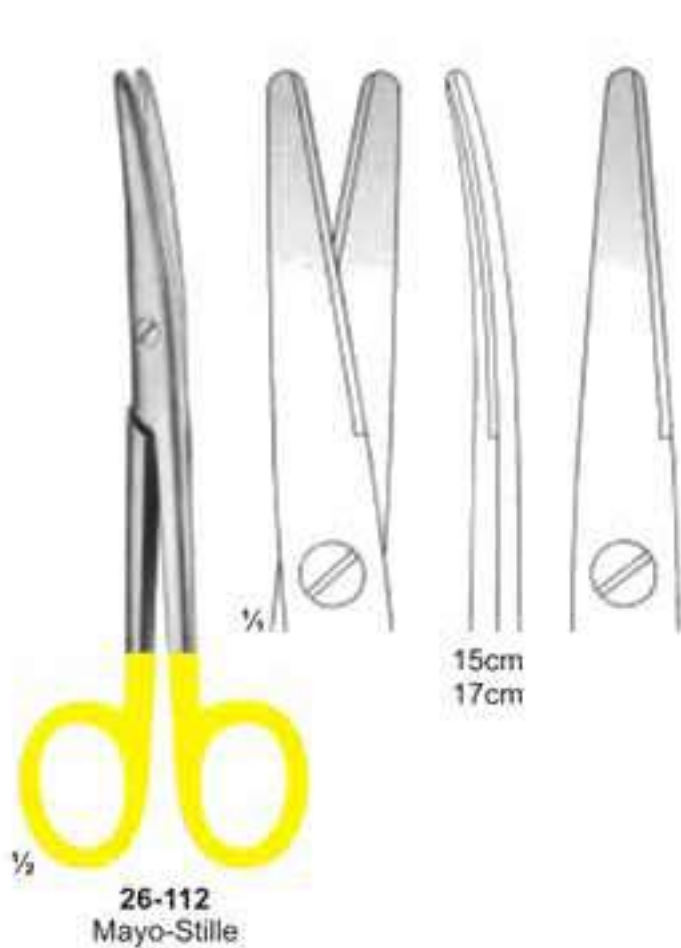
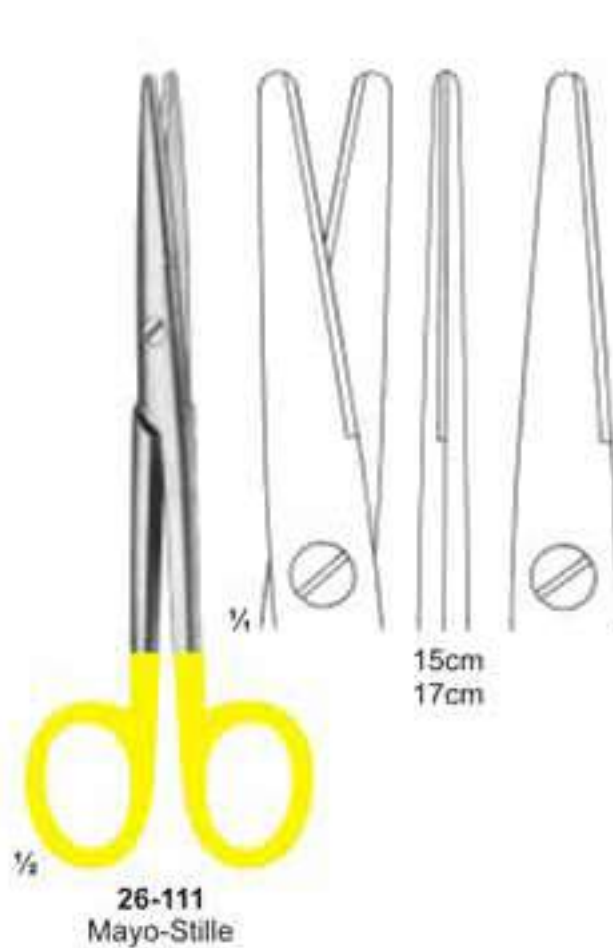
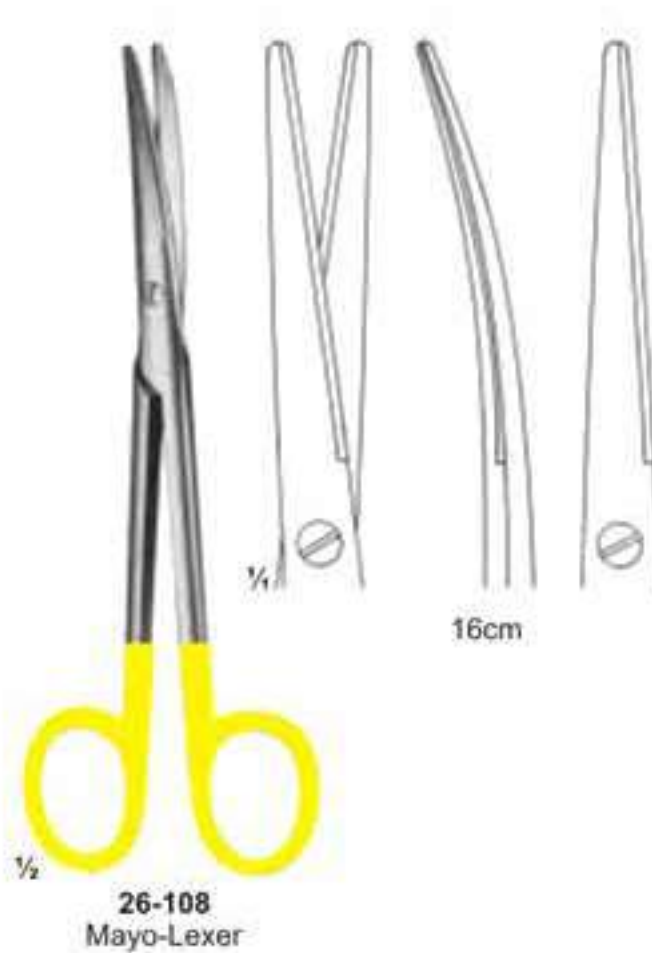
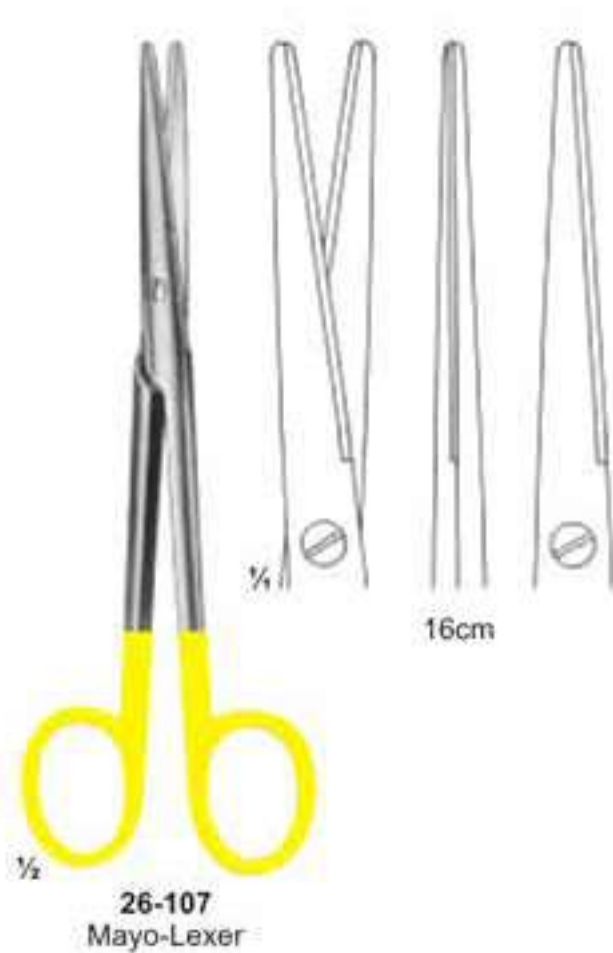

## Scissors with Tungsten Carbide Inserts



## Scissors with Tungsten Carbide Inserts

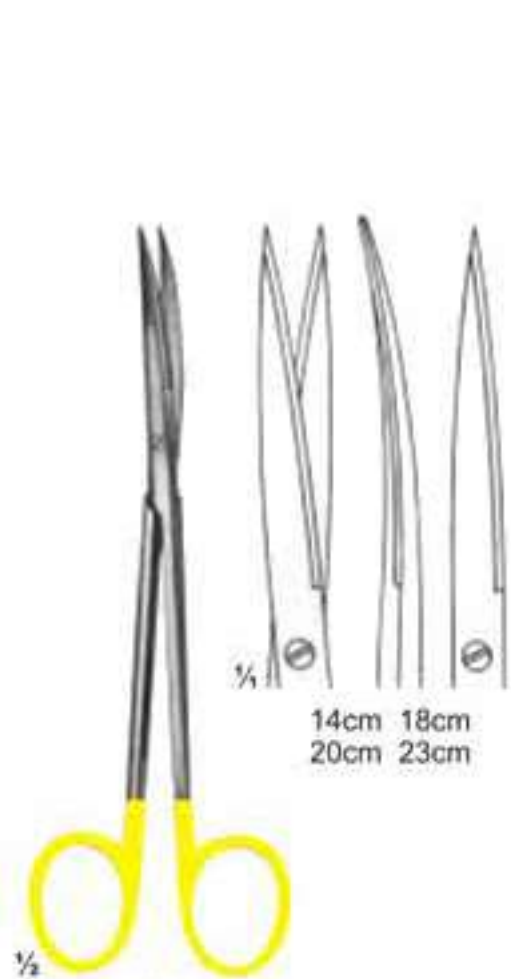

**26-119**  
Metzenbaum-Fino

14cm 18cm  
20cm 23cm

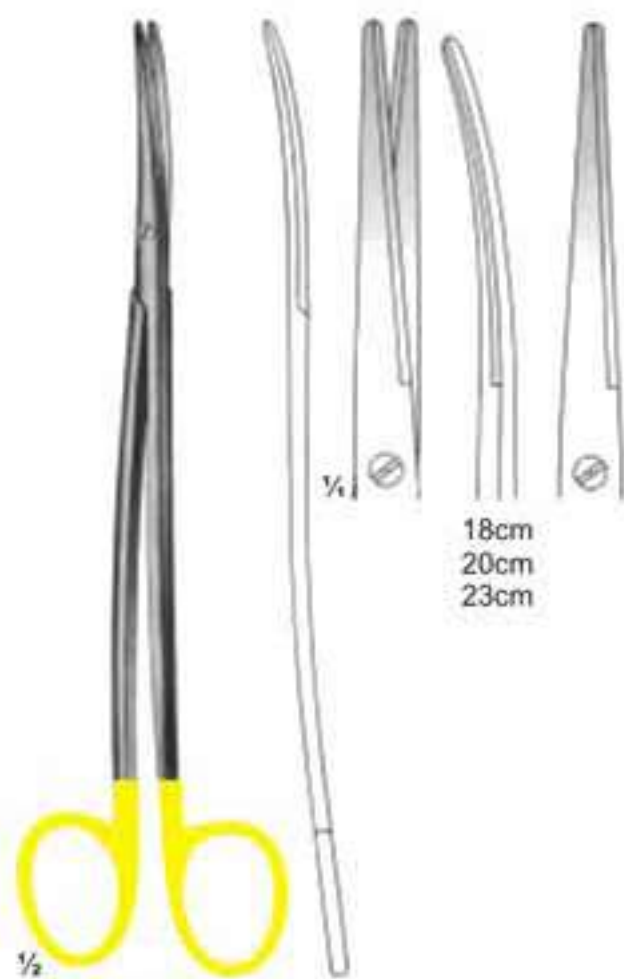

**26-120**  
Metzenbaum-Fino

18cm  
20cm  
23cm

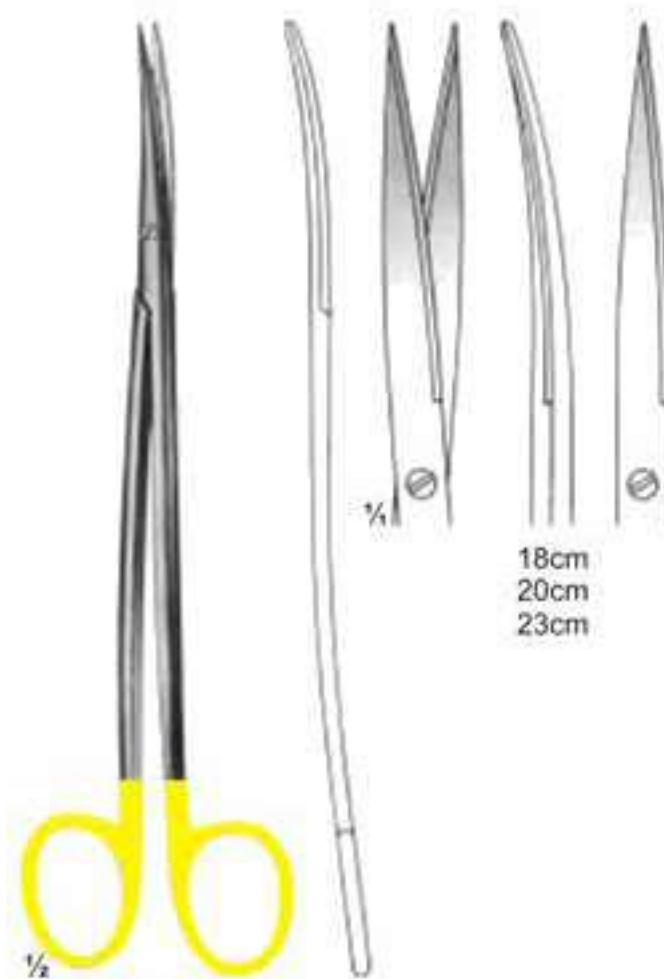

**26-121**  
Metzenbaum-Fino

18cm  
20cm  
23cm



**26-122**  
Metzenbaum

20cm  
23cm

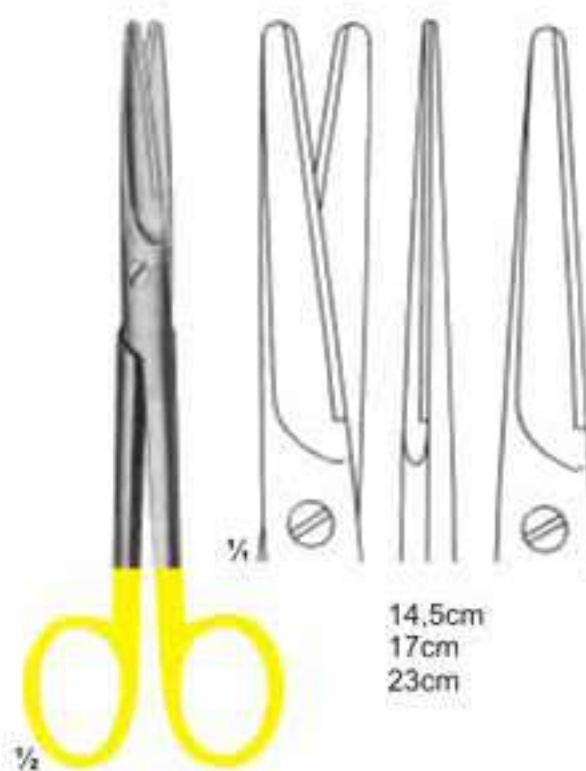

**26-123**  
Mayo

14,5cm  
17cm  
23cm



**26-124**  
Mayo

14,5cm  
17cm  
23cm

## Scissors with Tungsten Carbide Inserts



## Scissors with Tungsten Carbide Inserts

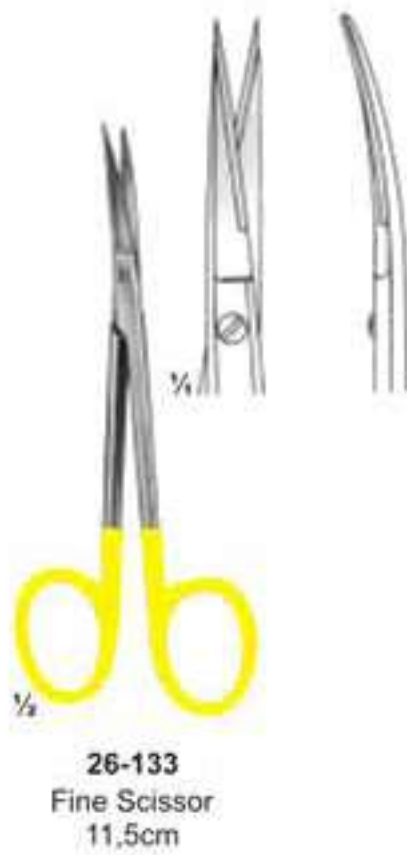
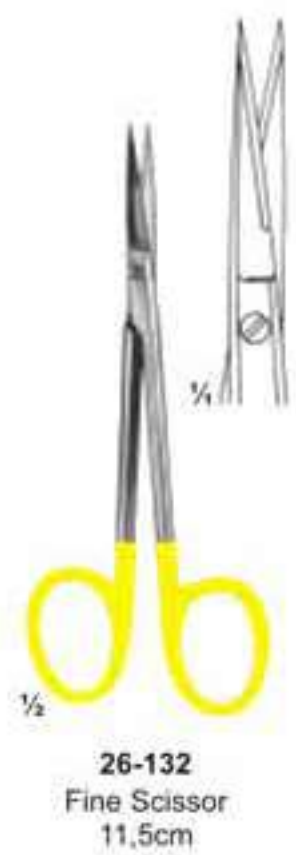
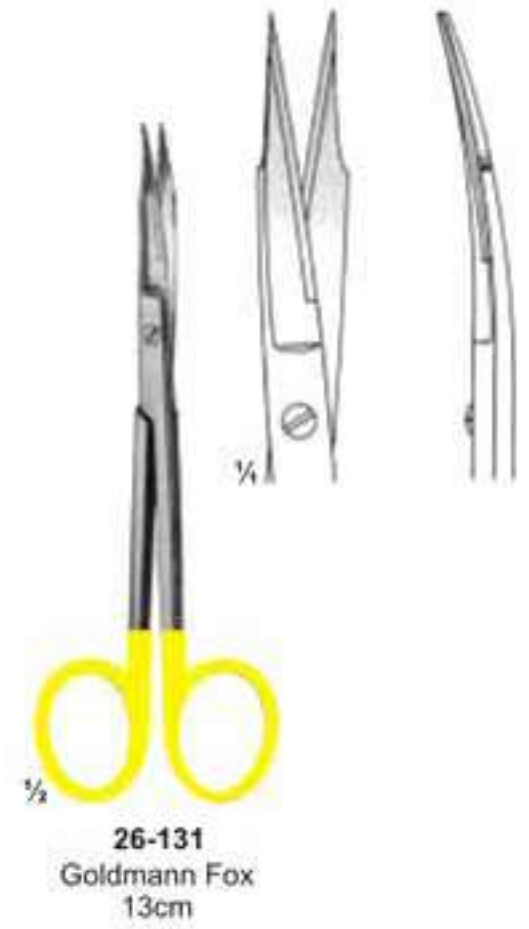

## Scissors & Dissecting Forceps with Tungsten Carbide Inserts

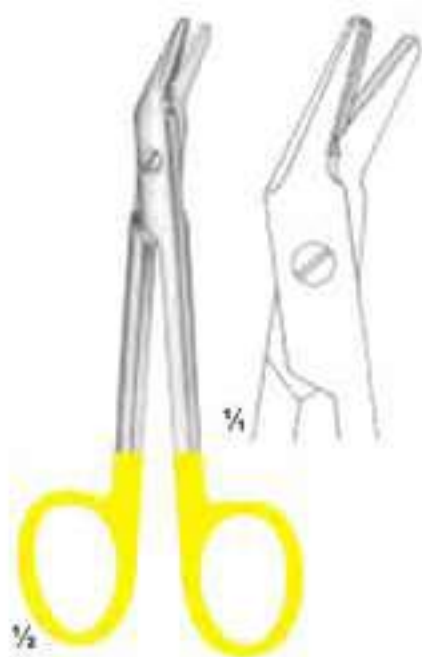

**26-136**  
Universal  
12cm



**26-137**  
Ligature Scissors  
1 Black & 1 Goldplated ring

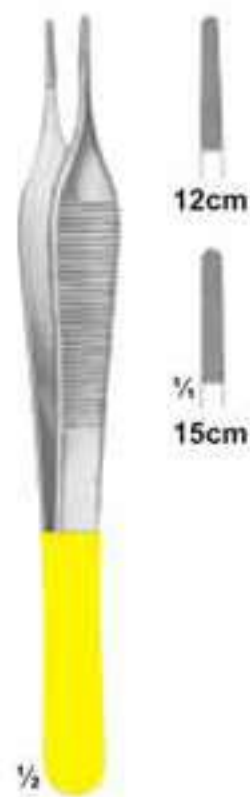

**26-138**  
Adson



**26-139**  
Cushing  
17.5cm



**26-140**  
Cushing  
18cm



**26-141**  
Cushing-Taylor  
18cm



**26-142**  
Dissecting Forceps  
15cm



**26-143**  
Semken  
15cm



## Dissecting Forceps and Needle holders with

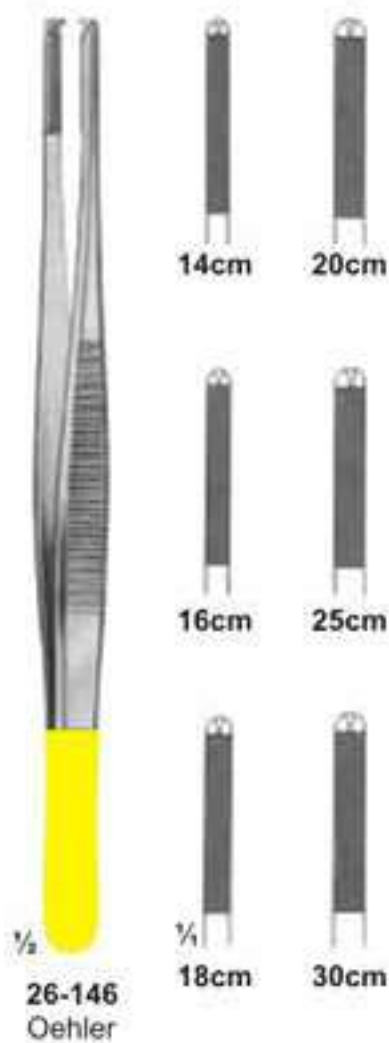
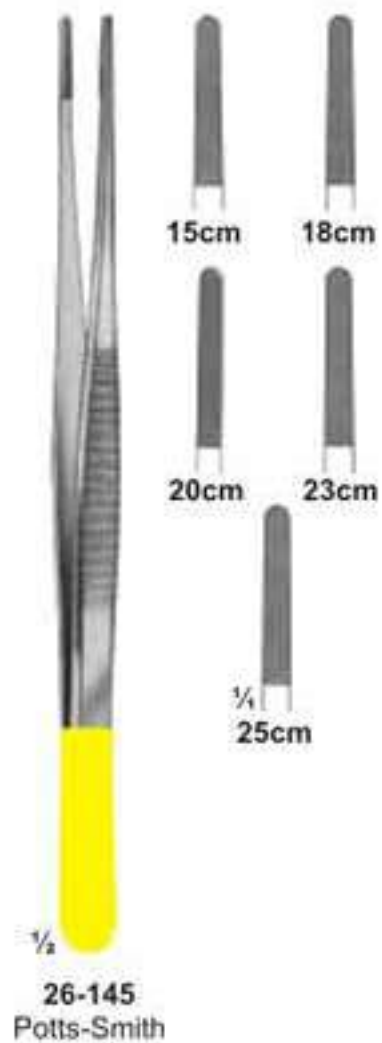
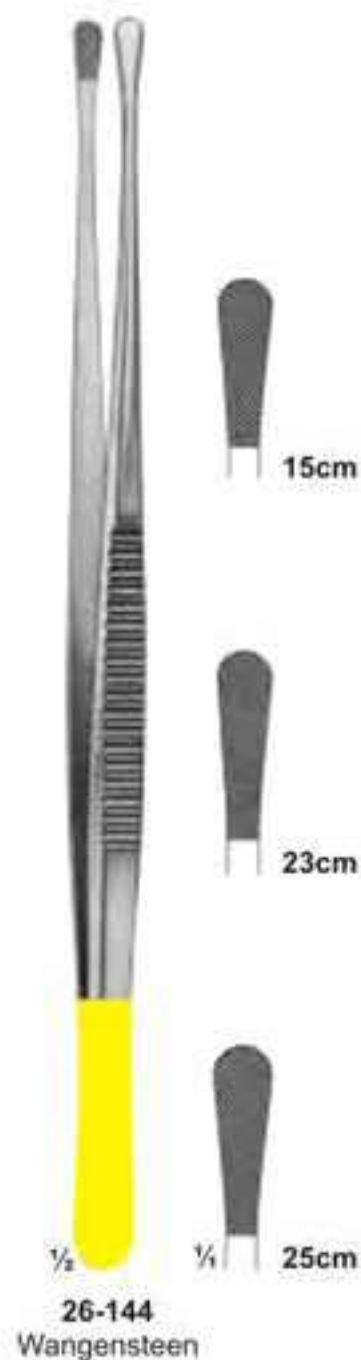

## Needle holders with Tungsten Carbide Inserts



**26-152**  
Arruga  
16cm



**26-153**  
Castroviejo  
13cm



**26-154**  
Hegar  
20cm 24cm

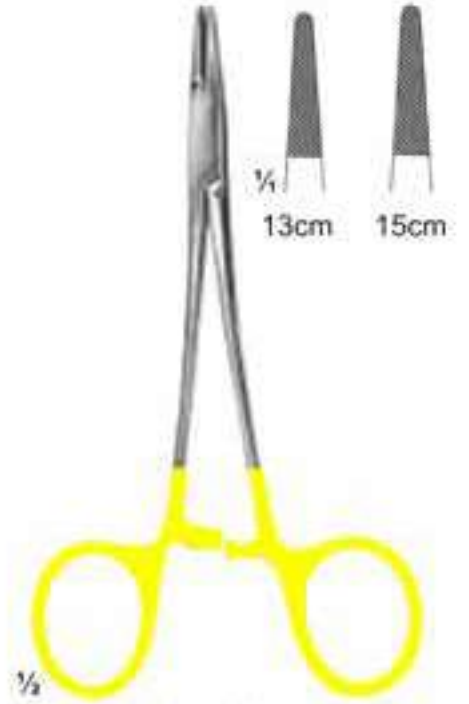

**26-155**  
Halsey  
13cm 15cm



**26-156**  
Mayo-Hegar  
16cm 18cm 20cm  
24cm 26cm 30cm



**26-157**  
De-Bakey  
18cm 20cm 23cm  
26cm 31cm 37cm

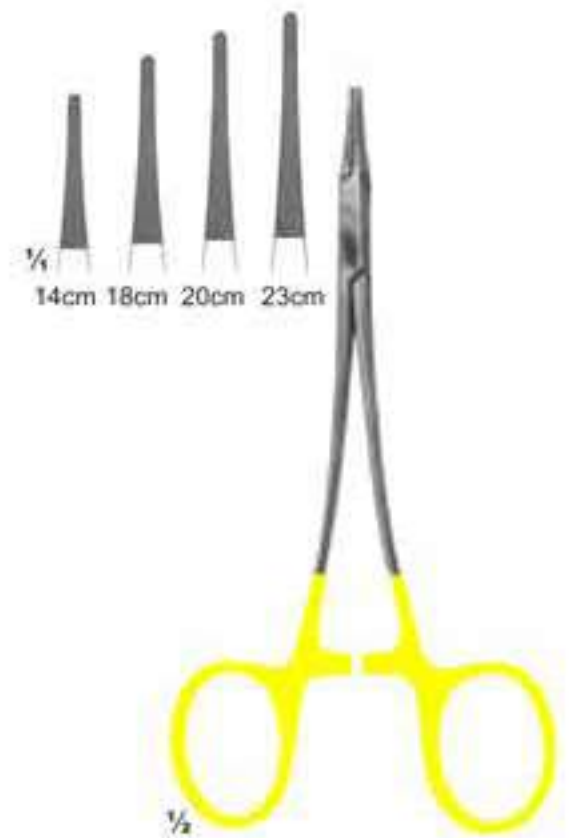

**26-158**  
Hegar-Vascular  
14cm 18cm  
20cm 23cm

## Needle holders with Tungsten Carbide Inserts



$\frac{1}{2}$   
**26-159**  
Bozemann-Wertheim  
20cm 24cm 26cm



$\frac{1}{2}$   
**26-160**  
Stratte  
22cm 23cm

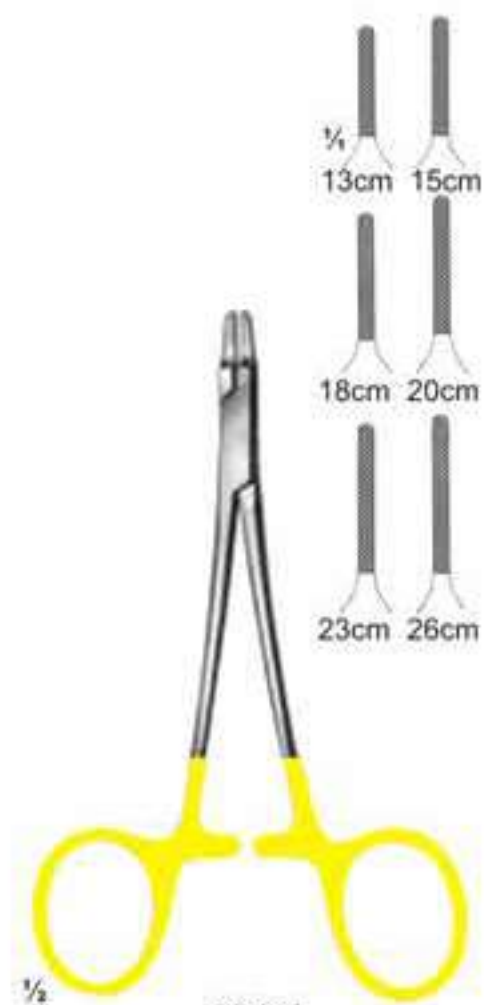

$\frac{1}{2}$   
**26-161**  
Ryder  
13cm 15cm 18cm  
20cm 23cm 26cm



$\frac{1}{2}$   
**26-162**  
Ryder-Vascular  
13cm 15cm 18cm  
20cm 23cm 26cm



$\frac{1}{2}$   
**26-163**  
Martin  
15cm 17cm 20cm



$\frac{1}{2}$   
**26-164**  
Sarot  
18cm 20cm 26cm

## Needle holders with Tungsten Carbide Inserts



## Needle holders with Tungsten Carbide Inserts



$\frac{1}{2}$   
**26-172**  
Mathieu-Ryder  
17cm  
20cm 24cm



$\frac{1}{2}$   
**26-173**  
Lichtenberg  
20cm



$\frac{1}{2}$   
**26-174**  
Langhals  
20cm 25cm



$\frac{1}{2}$   
**26-175**  
Lichtenberg  
20cm 25cm



$\frac{1}{2}$   
**26-176**  
Luehty-Beck  
20cm 25cm



$\frac{1}{2}$   
**26-177**  
Luehty-Beck  
20cm 25cm



$\frac{1}{2}$   
**26-178**  
Langebeck  
18cm  
20cm 23cm

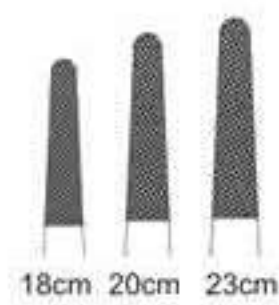

$\frac{1}{2}$   
**26-179**  
Langebeck-beck  
18cm  
20cm 23cm

## Wire Cutting Plier With T.C. Inserts



**26-180**  
**TOENNIS**  
Elastic pattern for  
dura-or intestinal suture  
180 mm



**26-181**  
Cutting Plier  
12 cm

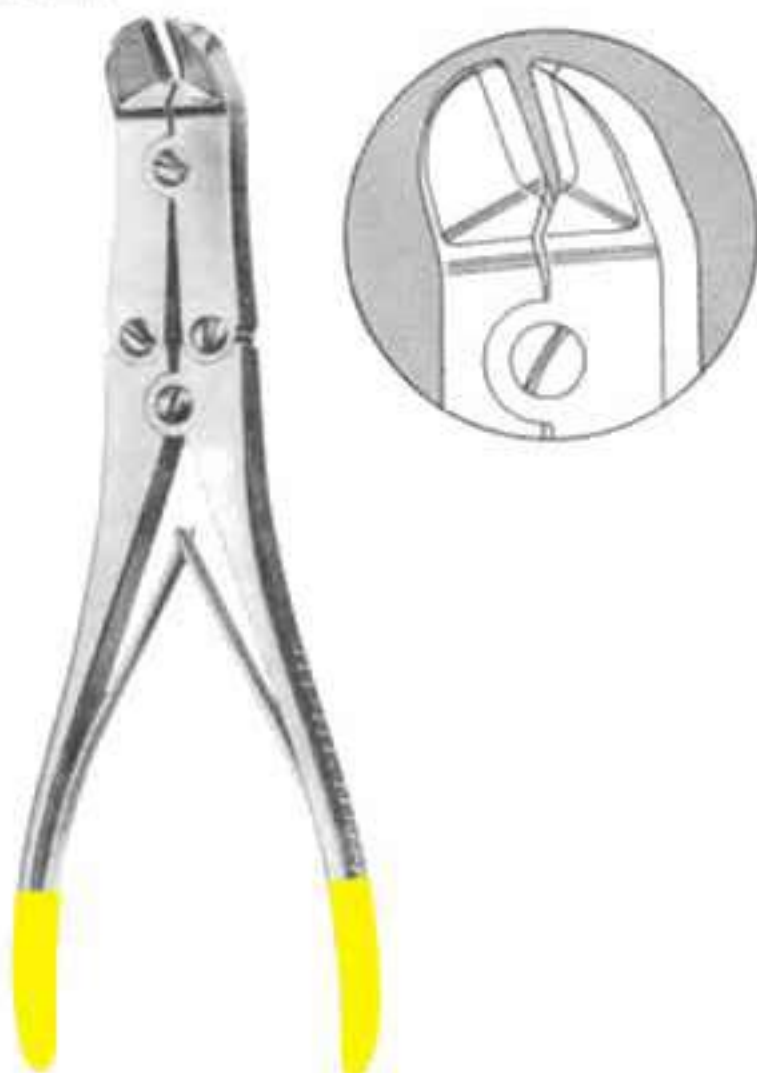

**26-182**  
**MULLAR CLAUS**  
22 cm



**26-183**  
Plier  
17.5 cm

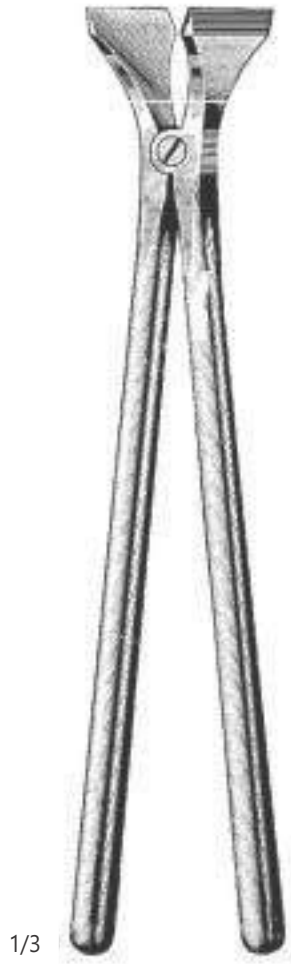

1/3

Beeson  
27-001  
30cm/12"

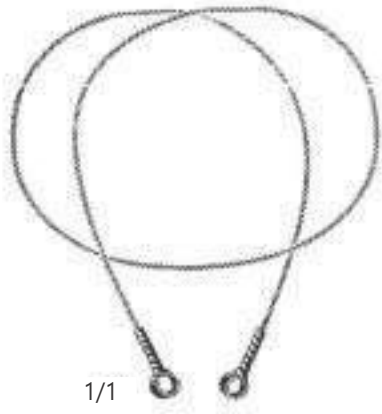

1/1

Gigli  
27-002 30 cm / 12"  
27-003 40 cm / 15 3/4"  
27-004 50 cm / 19 3/4"



1/2

Mayfeil  
27-005  
18 cm / 7"



1/1



Ruskin-Mini  
27-006 to 27-009  
15 cm / 6"



1/1



1/1



1/1



1/1



Marquardt  
27-010  
20 cm / 8"



1/1

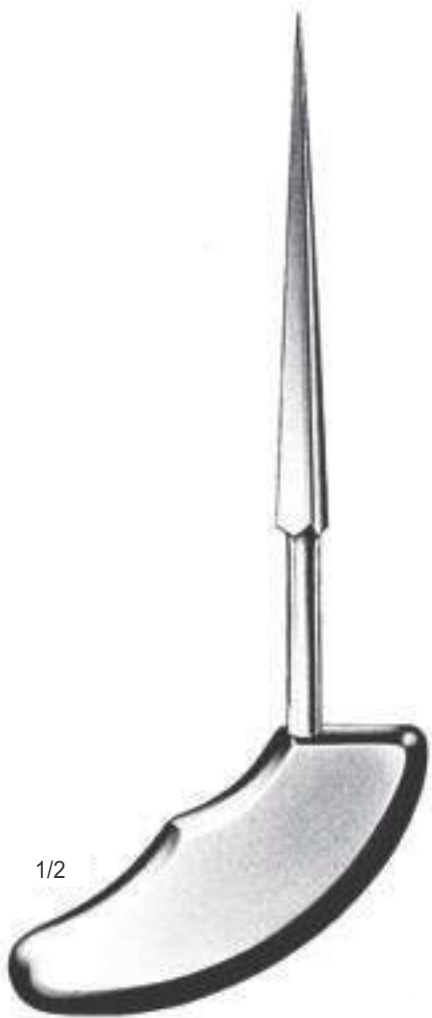

1/2

Perthes  
27-011  
21 cm / 8 1/4"



1/1



1/2

27-012  
25 cm / 10"



1/1



1/2

27-013  
25 cm / 10"



1/1



1/2

27-014  
25 cm / 10"



1/1



1/2

Phillips  
27-015  
25 cm / 10"



1/1



1/2

27-016  
25 cm / 10"



1/1



1/2

27-017  
17 cm / 6 3/4"



27-018  
24 cm / 9 1/2"



Jewett  
27-019  
20 cm / 8"

Parham  
27-020 18 cm / 7" X5mm  
27-021 20 cm / 8" X5mm  
27-022 25 cm / 10" X3mm  
27-023 27 cm / 10 1/2" X5mm  
27-024 30 cm / 12" X5mm



27-025  
20 cm / 8"



1/1



For hard wires  
up to 2.5mm  
  
For soft wires  
up to 3.0mm

27-026  
23.5 cm / 9 1/4"

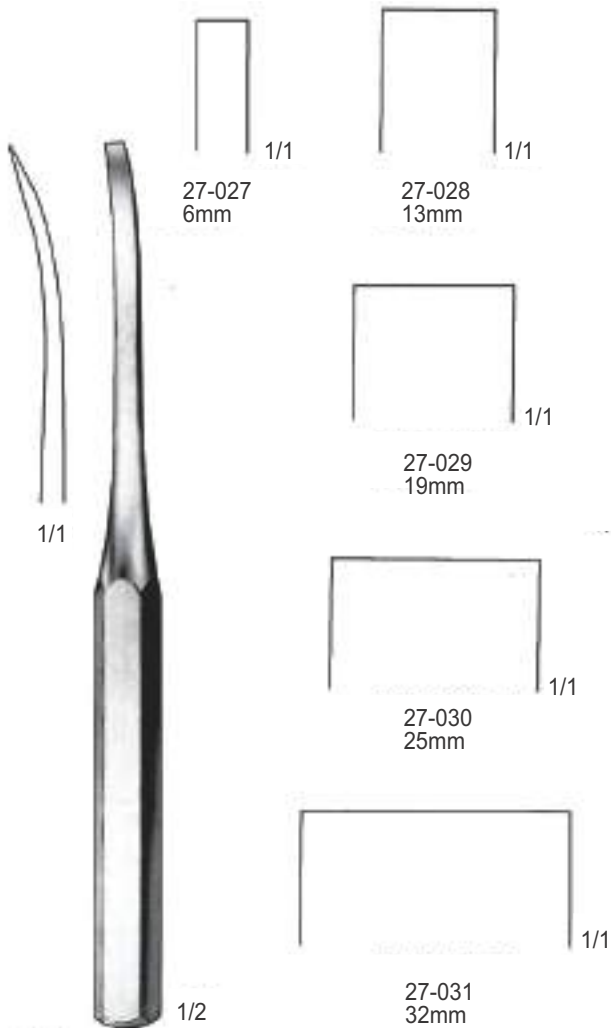

1/1

Hibbs  
24 cm / 9 1/2"  
27-027 27-031

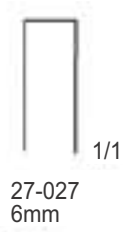

1/1

27-027  
6mm

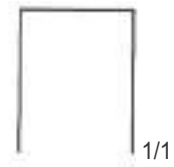

1/1

27-028  
13mm

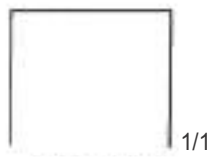

1/1

27-029  
19mm



1/1

27-030  
25mm



1/1

27-031  
32mm



1/1

1/2

Hibbs  
24 cm / 9 1/2"  
27-032 27-036

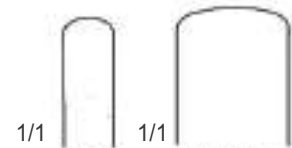

1/1

27-032  
6mm

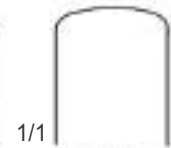

1/1

27-033  
13mm



1/1

27-034  
19mm



1/1

27-035  
25mm



1/1

27-036  
32mm





1/2

Hohmann  
27-037  
24 cm/9 1/2"

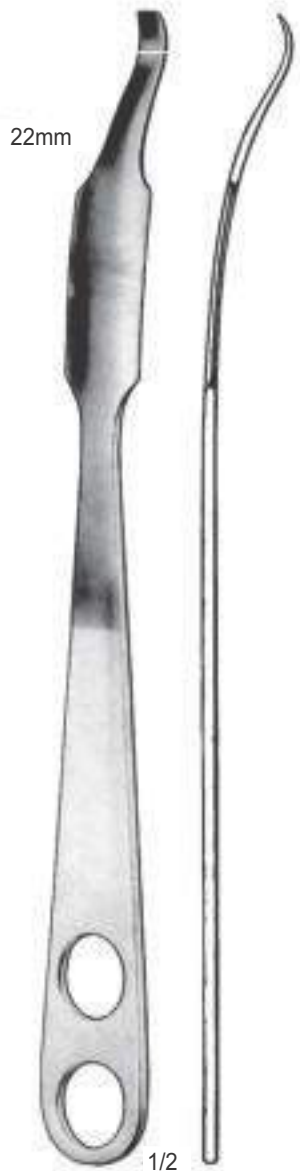

22mm

1/2

Hohmann  
27-038  
25 cm/10"



24mm

1/2

Hohmann  
27-039  
27 cm/10 1/2"



22mm

1/2

Large-Hohmann  
27-040  
25 cm/10"



17mm

1/2

1/1

Wegner  
27-041  
22 cm/8 3/4"

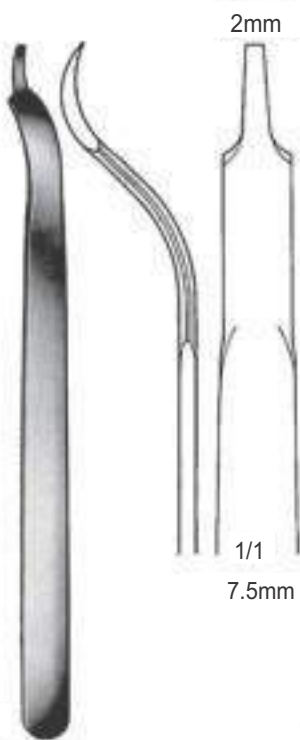

1/2

Buck-Gramcko  
27-042  
15 cm/6"

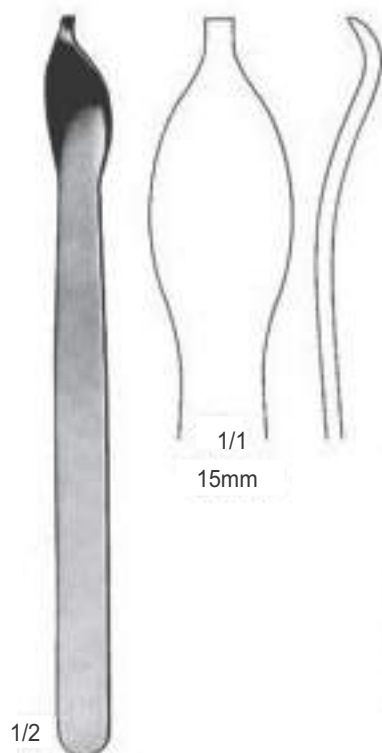

1/1  
15mm

1/2

27-043  
15 cm/6"



1/2

Bruns  
17 cm/6 3/4"  
27-044 to 27-053

1/1  
Fig.0000  
27-044

1/1  
Fig.0  
27-047

1/1  
Fig.3  
27-050

1/1  
Fig.000  
27-045

1/1  
Fig.1  
27-048

1/1  
Fig.4  
27-051

1/1  
Fig.6  
27-053

1/1  
Fig.00  
27-046

1/1  
Fig.2  
27-049

1/1  
Fig.5  
27-052



Cobb  
25 cm / 10"  
27-054 to 27-057



1/1



1/1

27-054  
10mm



1/1

27-055  
13mm



1/1

27-056  
19mm



1/1

27-057  
25mm



Valkmann  
17 cm/6 3/4"  
27-058 to 27-067



1/1

Fig.0000  
27-058



1/1

Fig.000  
27-059



1/1

Fig.00  
27-060



1/1

Fig.2  
27-061



1/1

Fig.3  
27-062



1/1

Fig.4  
27-063



1/1

Fig.00  
27-064



1/1

Fig.1  
27-065



1/1

Fig.5  
27-066



1/1

Fig.6  
27-067



Bruns (Valkmann)  
21 cm/8 1/4"  
27-068 to 27-077



1/1

27-068  
27-078

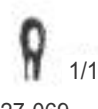

1/1

27-069  
27-079



1/1

27-070  
27-080



1/1

27-071  
27-081



1/1

27-072  
27-082



1/1

27-073  
27-083



1/1

27-074  
27-084



1/1

27-075  
27-085



1/1

27-076  
27-086



1/1

27-077  
27-087

1/1



Bruns (Valkmann)  
21 cm/8 1/4"  
27-078 to 27-087



1/2

Lampert  
27-088 to 27-095  
20cm / 8"

1/1  
Fig.0000000  
27-088

1/1  
Fig.0000000  
27-089

1/1  
Fig.000000  
27-090

1/1  
Fig.000000  
27-091

1/1  
Fig.000  
27-092

1/1  
Fig.00  
27-093

1/1  
Fig.0  
27-094

1/1  
Fig.1  
27-095



1/2

Caspar  
27-096 to 27-104  
22cm / 8 3/4"

1/1  
Fig.000  
27-096

1/1  
Fig.00  
27-097

1/1  
Fig.0  
27-098

1/1  
Fig.000  
27-099

1/1  
Fig.00  
27-100

1/1  
Fig.0  
27-101

1/1  
Fig.000  
27-102

1/1  
Fig.00  
27-103

1/1  
Fig.0  
27-104



27-105  
16.5cm / 6 1/2"



27 mm Ø  
140 g

Hajek  
27-106  
21.5 cm 8 1/2"



1/2

Volkman  
27-107 to 27-118  
25cm / 10"

1/1  
Fig.000  
27-107

1/1  
Fig.00  
27-108

1/1  
Fig.0  
27-109

1/1  
Fig.1  
27-110

1/1  
Fig.000  
27-111

1/1  
Fig.00  
27-112

1/1  
Fig.0  
27-113

1/1  
Fig.1  
27-114

1/1  
Fig.000  
27-115

1/1  
Fig.00  
27-116

1/1  
Fig.0  
27-117

1/1  
Fig.1  
27-118



Williger  
27-119 to 27-121  
24 cm 8 1/2"

27-119  
28mmØ  
300g

27-120  
28mmØ  
340g

27-121  
30mmØ  
400g



490 g

27-122  
24 cm 9 1/2"

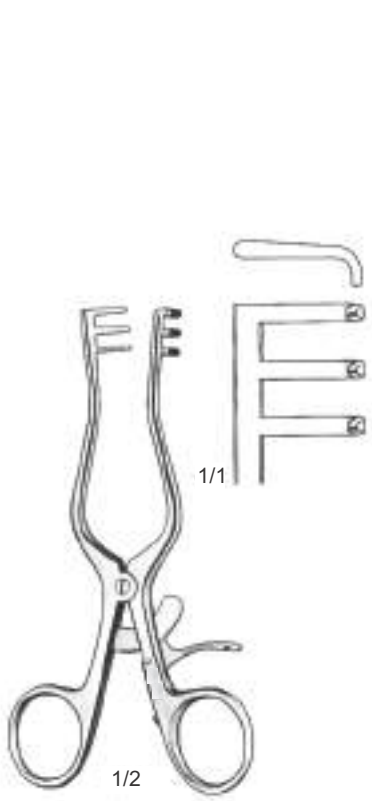

Milligen  
27-123  
13 cm / 5½"  
3 x 3 Prongs

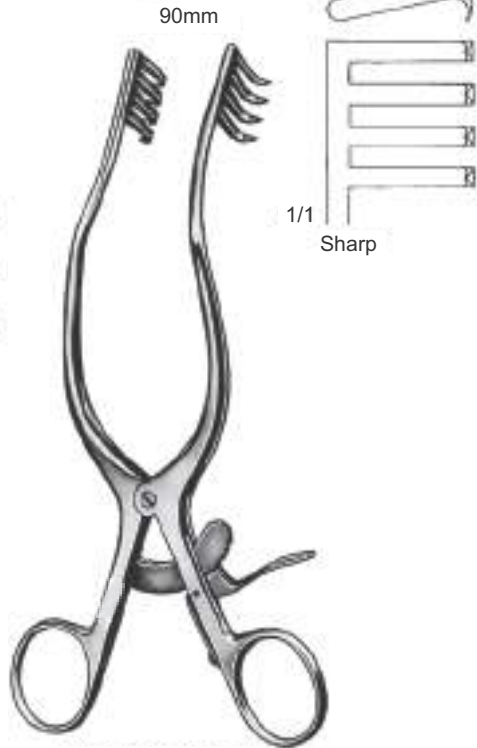

Anderson-Adcon  
27-124  
20cm / 8"  
4 x 4 Prongs



Mickiman  
27-125 Sharp  
27-126 Blunt  
22cm / 8¾"  
7 x 7 Prongs



Colin	Opening	Lateral Blades	Central Blades
27-127	135mm	37 x 62mm	54 x 55mm
27-128	160mm	37 x 80mm	54 x 67mm
27-129	160mm	37 x 98mm	52 x 76mm



Adson  
27-130 to 27-133  
26.5 cm / 10½"

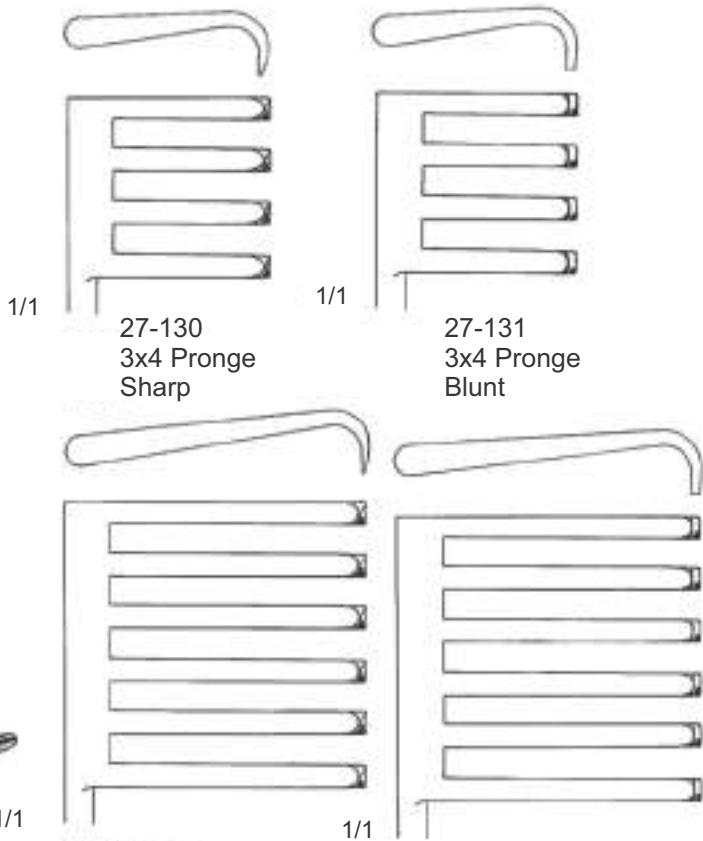

27-130  
3x4 Prong  
Sharp

27-131  
3x4 Prong  
Blunt

27-132  
6x6 Prong  
Sharp

27-133  
6x6 Prong  
Blunt

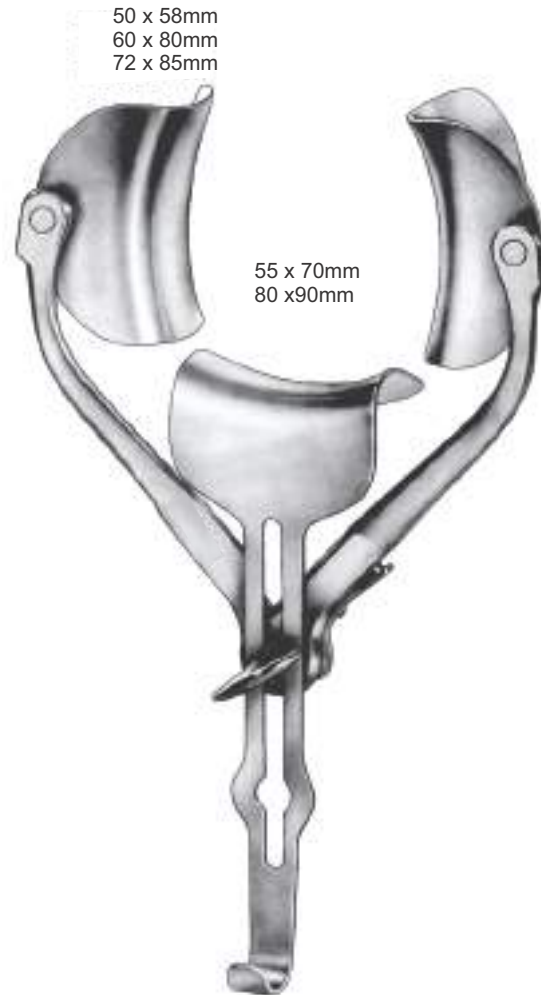

Ricard  
27-134 28cm / 11"  
27-135 30 cm / 13"



Colin-Locktite  
27-136  
26 cm / 10 1/4"

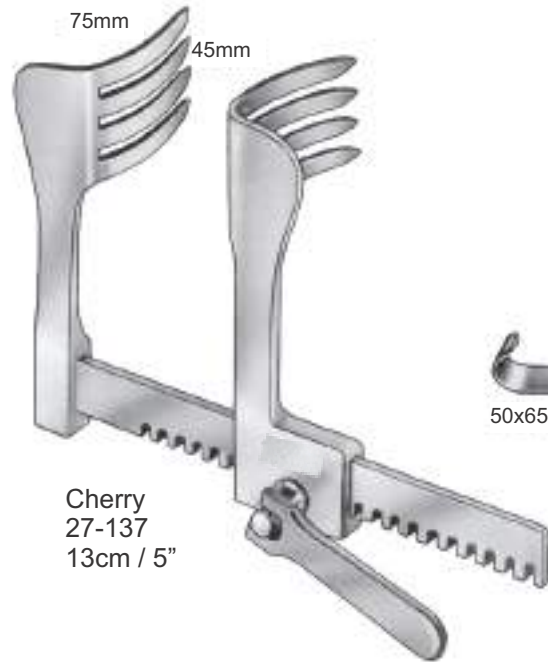

Cherry  
27-137  
13cm / 5"

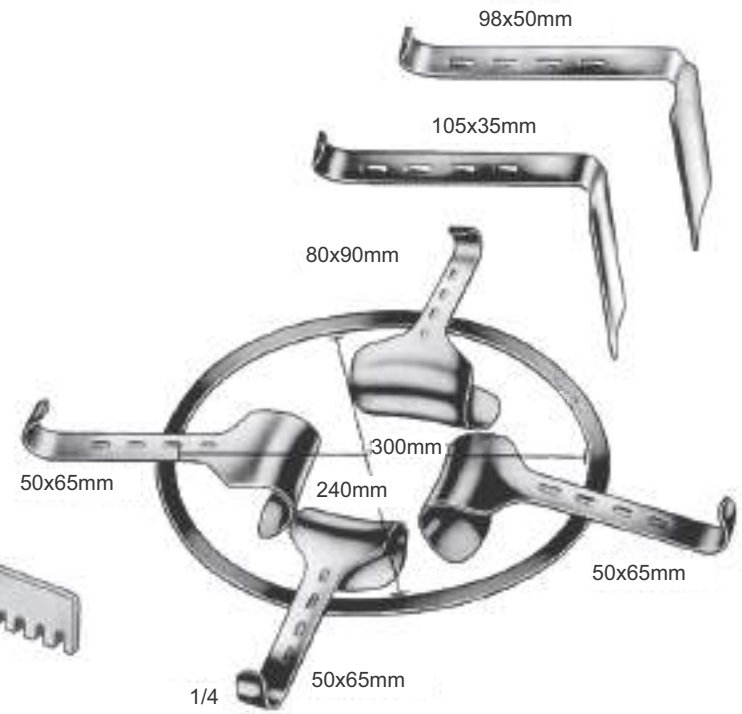

Kirschner (Semm), Ovel  
27-139  
Complete set consisting of  
1 Frame 300 x 240mm  
3 Hook on retractors 50x65mm  
1 Hook-on retractor 80x90  
1 Hook-on retractor 98x50  
1 Hook-on retractor 105x35

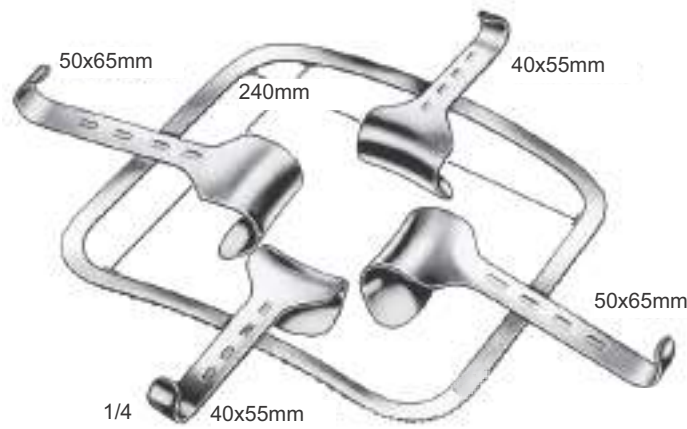

Kirscher  
27-138  
Complete set consisting of  
1 frame 240x240 mm  
2 Hook-on etrectors 40 x50mm  
2 Hook-on retractors 50x 65mm

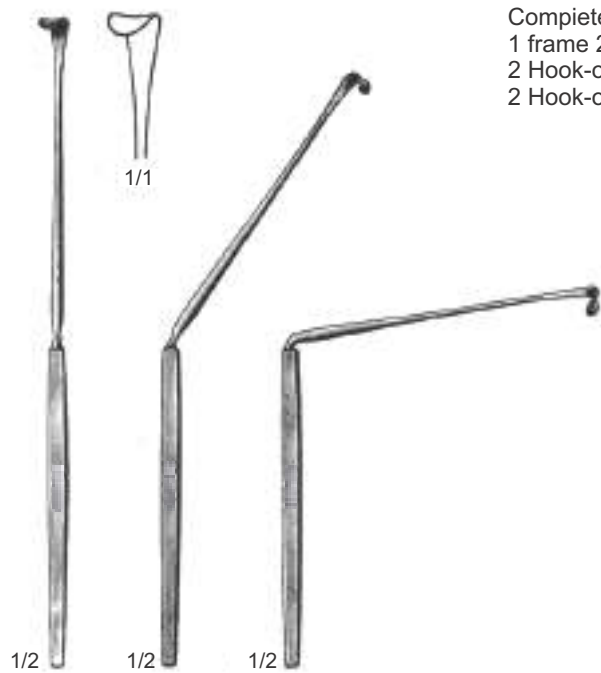

Love  
27-140  
19cm / 7 1/2"

Love  
27-141  
19cm / 7 1/2"  
45°

Love  
27-142  
19cm / 7 1/2"  
90°



Richardson  
27-143 to 27-146  
24cm / 9 1/2"

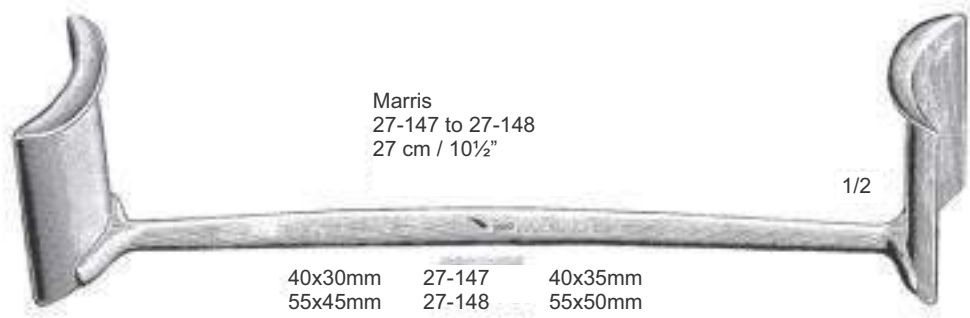

Marris  
27-147 to 27-148  
27 cm / 10½"

1/2

40x30mm	27-147	40x35mm
55x45mm	27-148	55x50mm



25mm

25mm

25mm

1/2

1/2

1/2

Deaver  
27-149  
30cm / 12"

Deaver  
27-150  
33cm / 13"

Deaver  
27-151  
36cm / 14"



137mm

1/2

27-152  
30cm/12"



40mm

1/2

Allison  
27-153  
25cm/10"



54mm

1/2

Allison  
27-154  
32cm/12¾"



1/3

Habere  
27-155 20cm/8" 17x25mm  
27-156 28cm/11" 25x30mm  
27-157 30cm/12" 37x45mm







1/3

27-158 30mm  
27-159 40mm  
27-160 50mm



1/1





Taynbee  
27-161 to 27-164

- |   |   |
|---|---|
| 1/1  | 1/1  |
| 27-161<br>No,1<br>4.5mmØ  | 27-162<br>No,2<br>5.5mmØ  |
| 1/1  | 1/1  |
| 27-163<br>No,3<br>6.5mmØ  | 27-164<br>No,4<br>7.5mmØ  |



1/1

Baucheron  
27-174 to 27-177

- |   |   |
|---|---|
| 1/1   | 1/1   |
| 27-174<br>No,1<br>4.5mmØ  | 27-175<br>No,2<br>5.5mmØ  |
| 1/1  | 1/1  |
| 27-176<br>No,3<br>6.5mmØ  | 27-177<br>No,4<br>7.5mmØ  |



1/2

Lempert  
27-165 to 171  
15cm / 6"



1/1 27-165    1/1 27-166    1/1 27-167    1/1 27-168

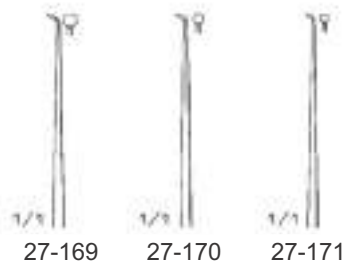

1/1 27-169    1/1 27-170    1/1 27-171



1/2

Buck  
27-172  
16cm / 6¼"



1/2

Politzer  
27-173  
16cm / 6¼"



1/1



1/1

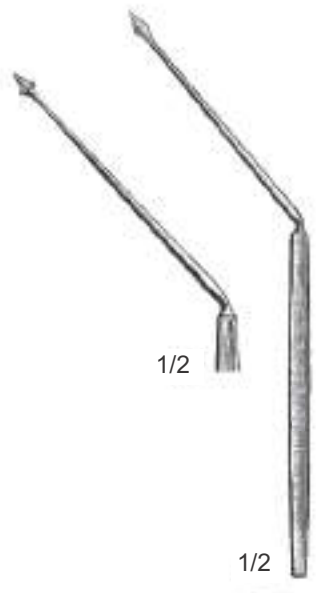

1/2

1/2

Politzer  
27-178  
16.5cm / 6½"



1/2

27-179 to 27-186  
15cm/8"

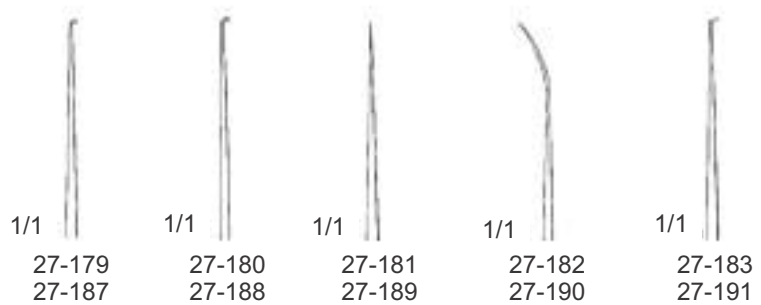

1/1 27-179    1/1 27-180    1/1 27-181    1/1 27-182    1/1 27-183  
27-187    27-188    27-189    27-190    27-191

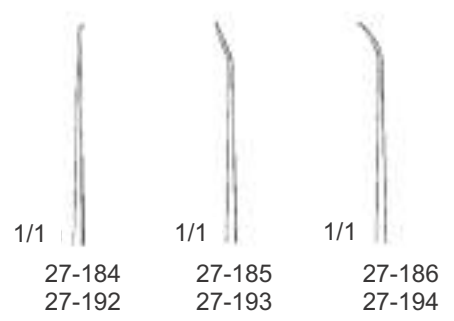

1/1 27-184    1/1 27-185    1/1 27-186  
27-192    27-193    27-194



Barbara  
27-187 to 27-194  
15cm / 8"

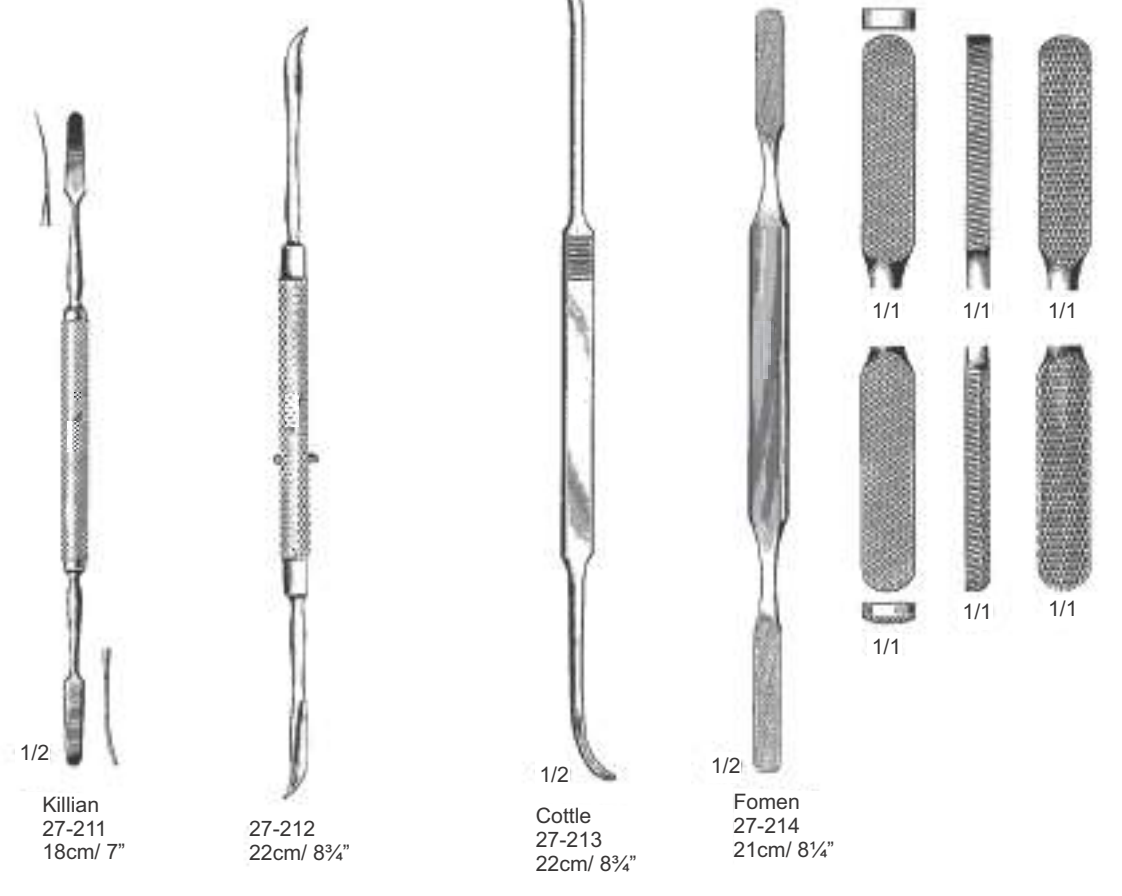
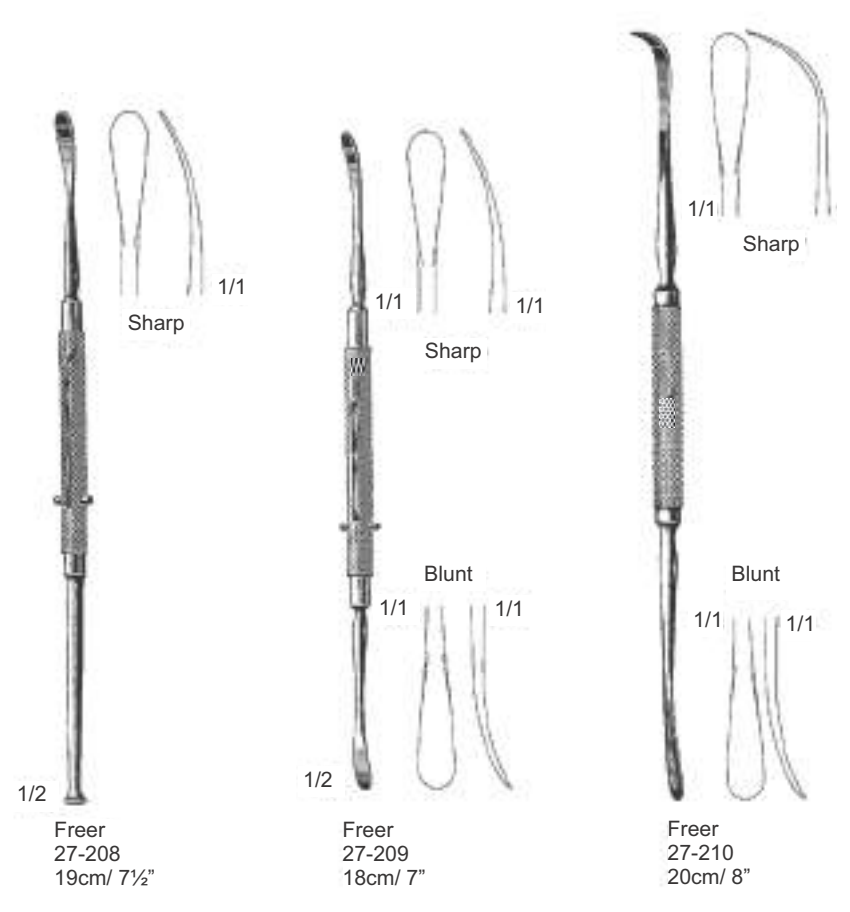
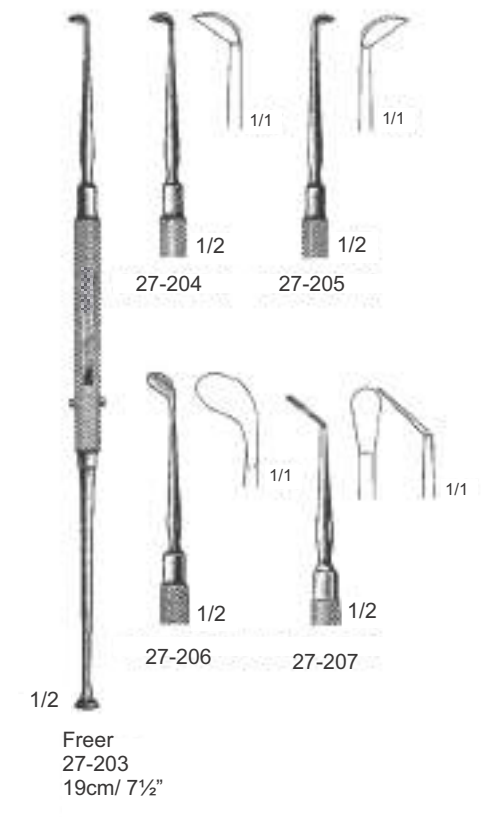
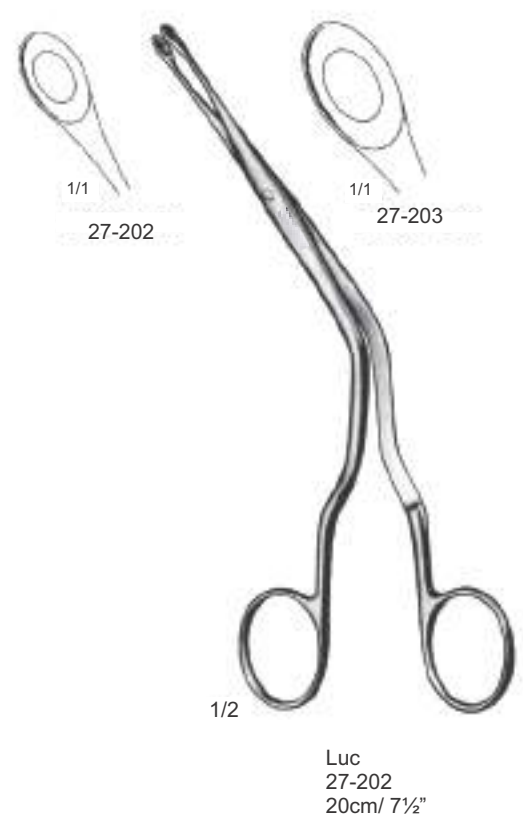
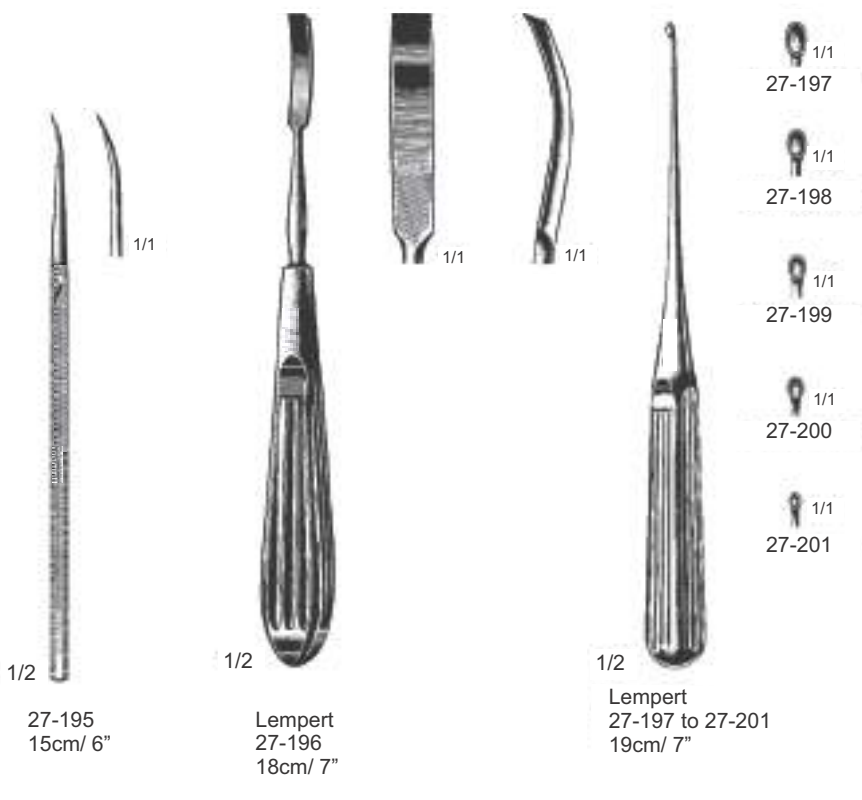



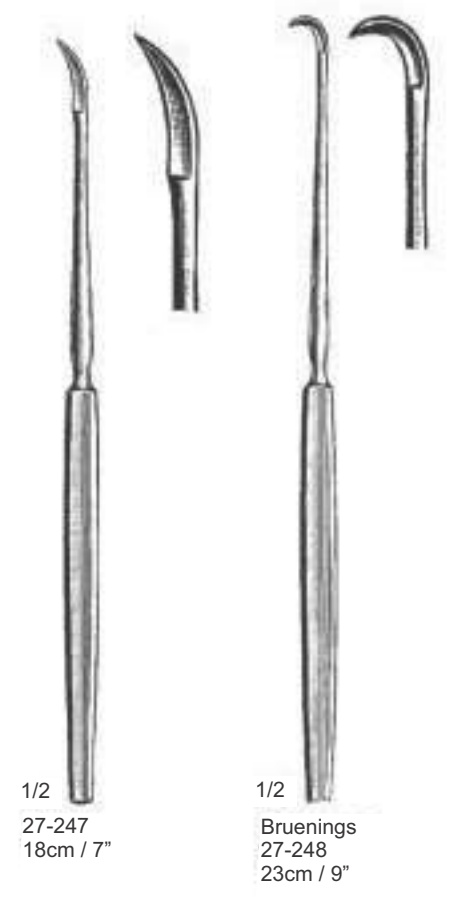
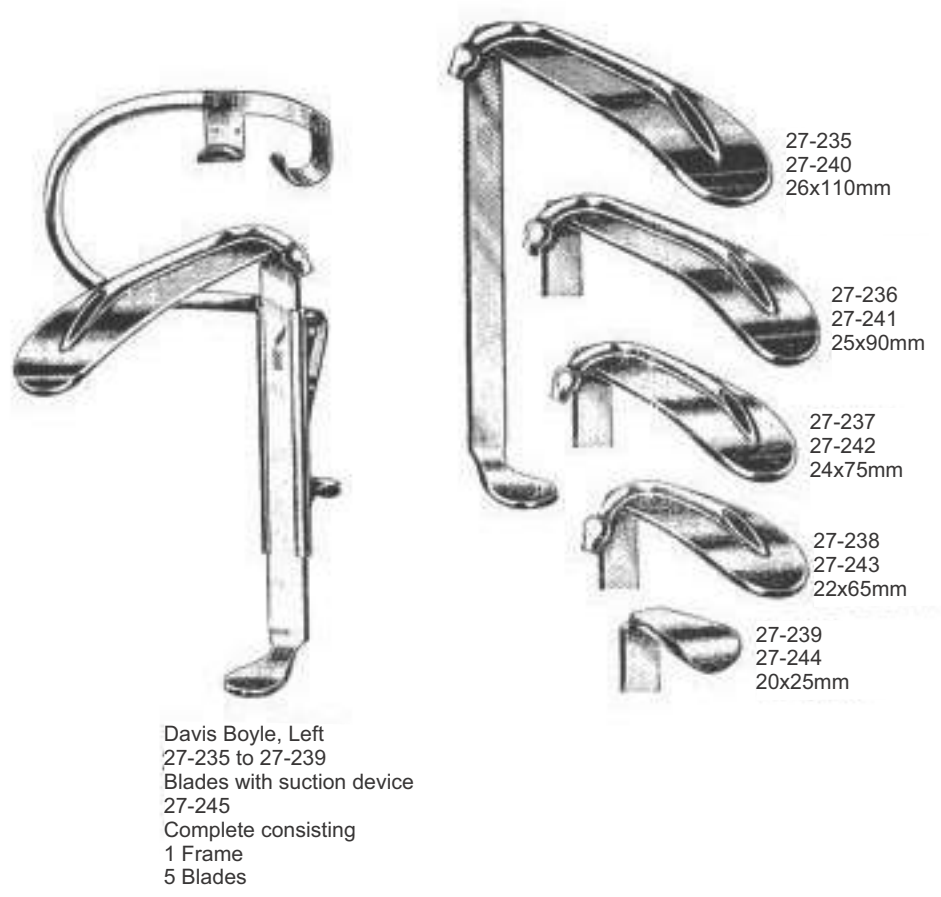
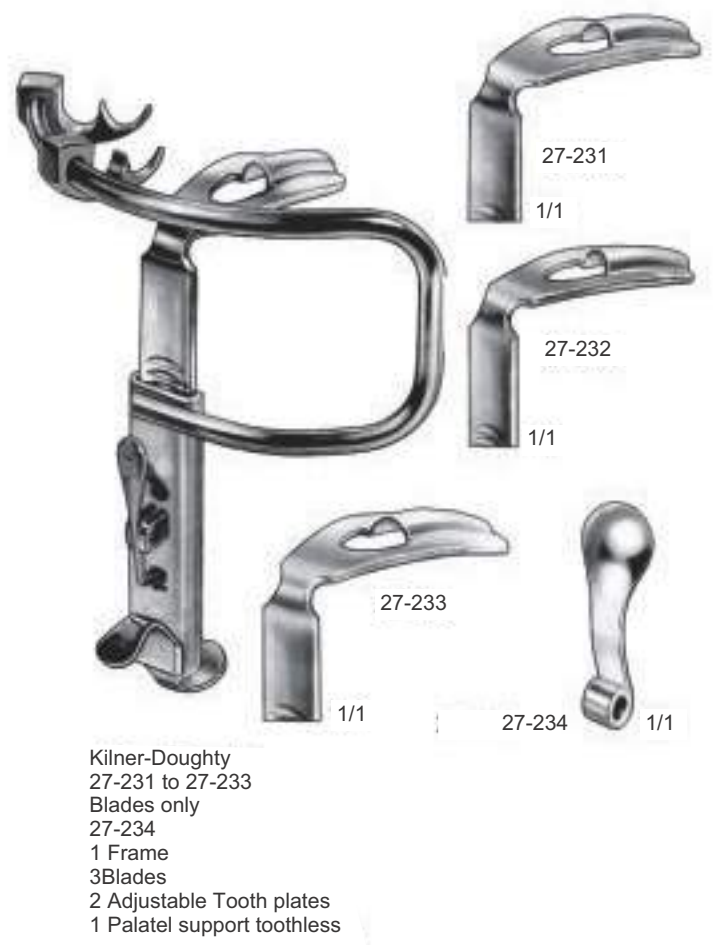
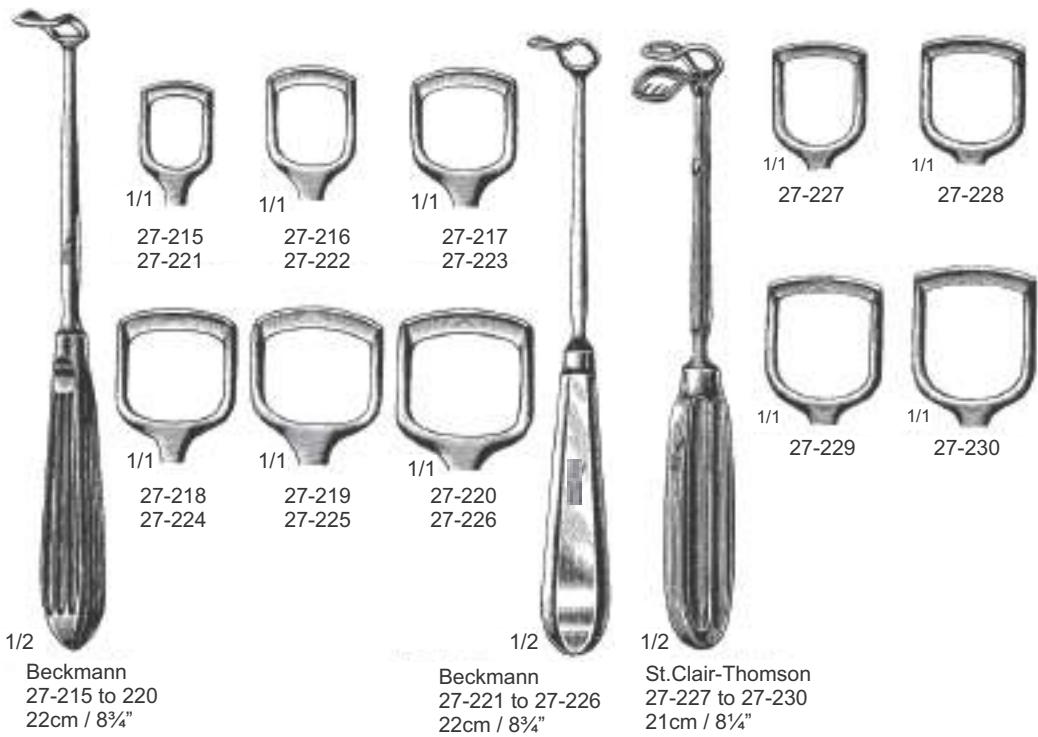

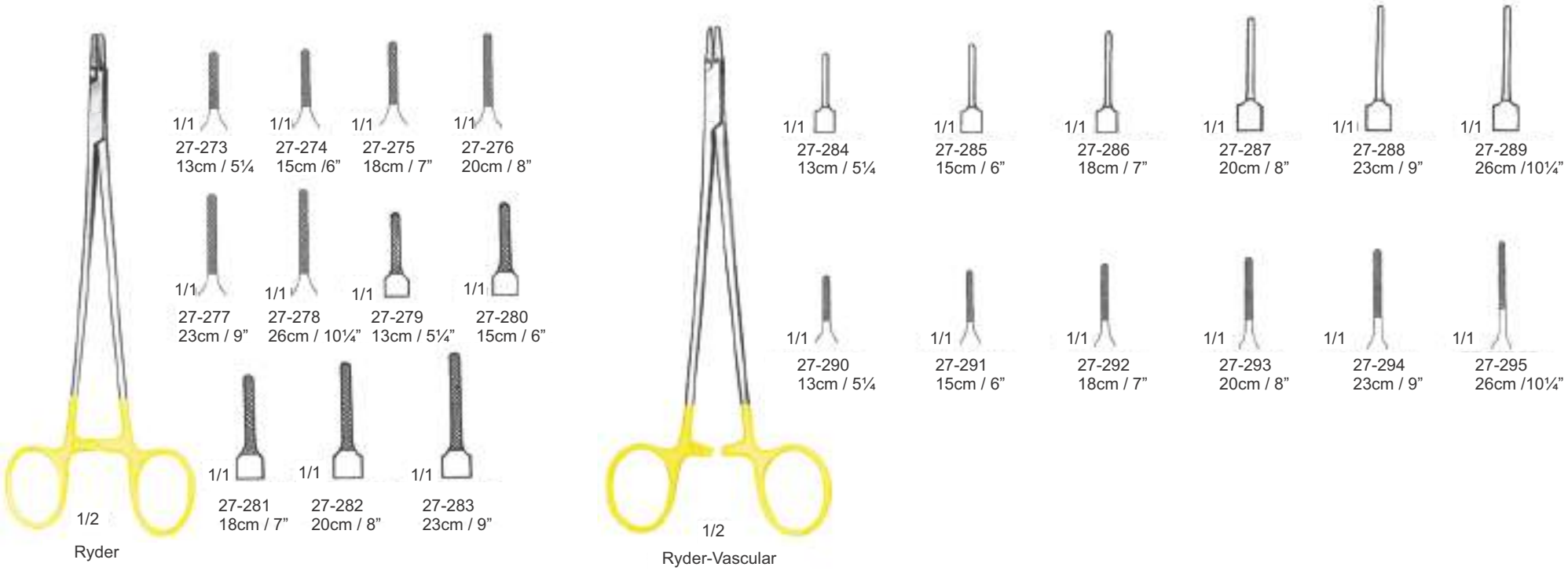
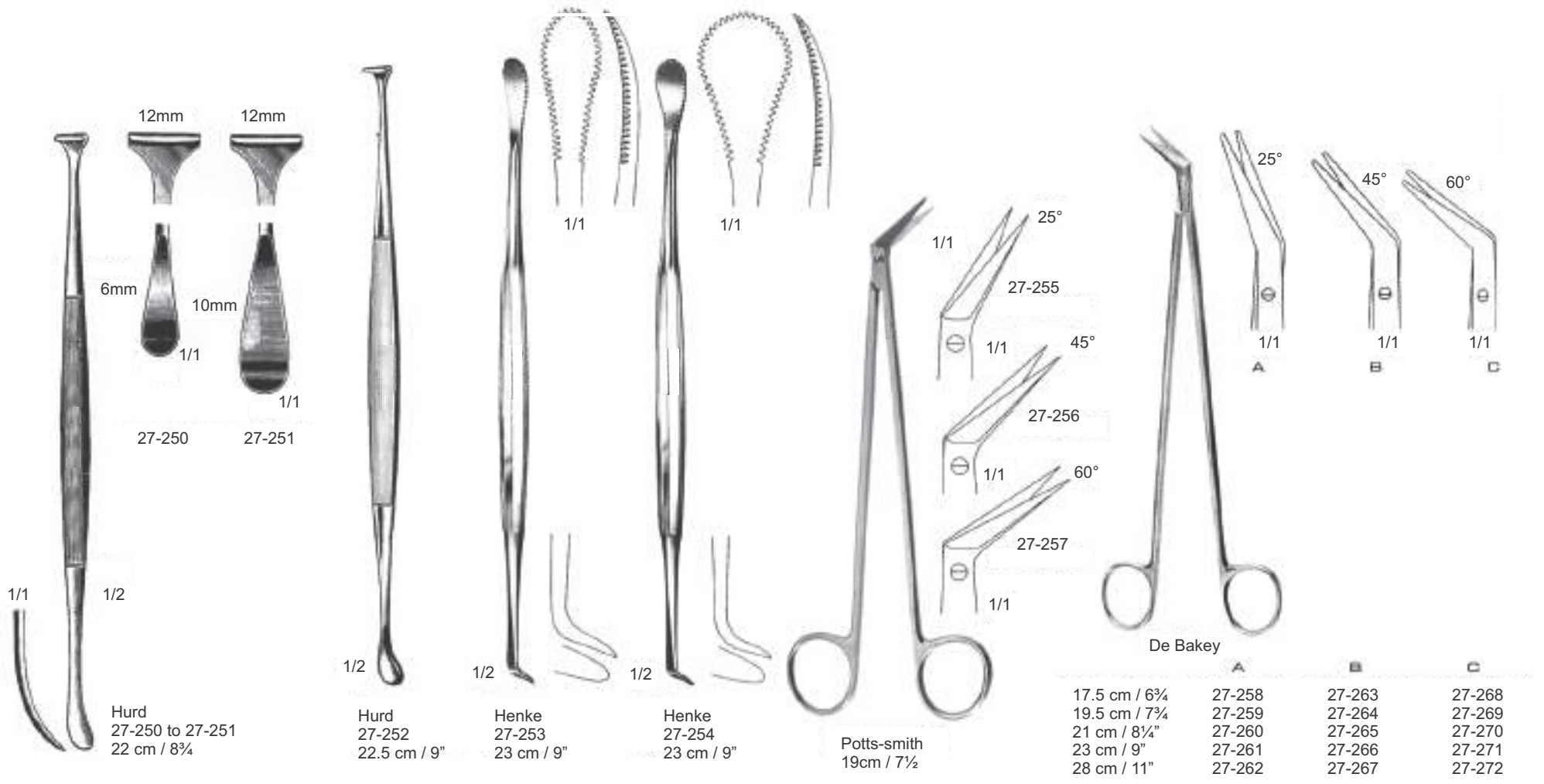

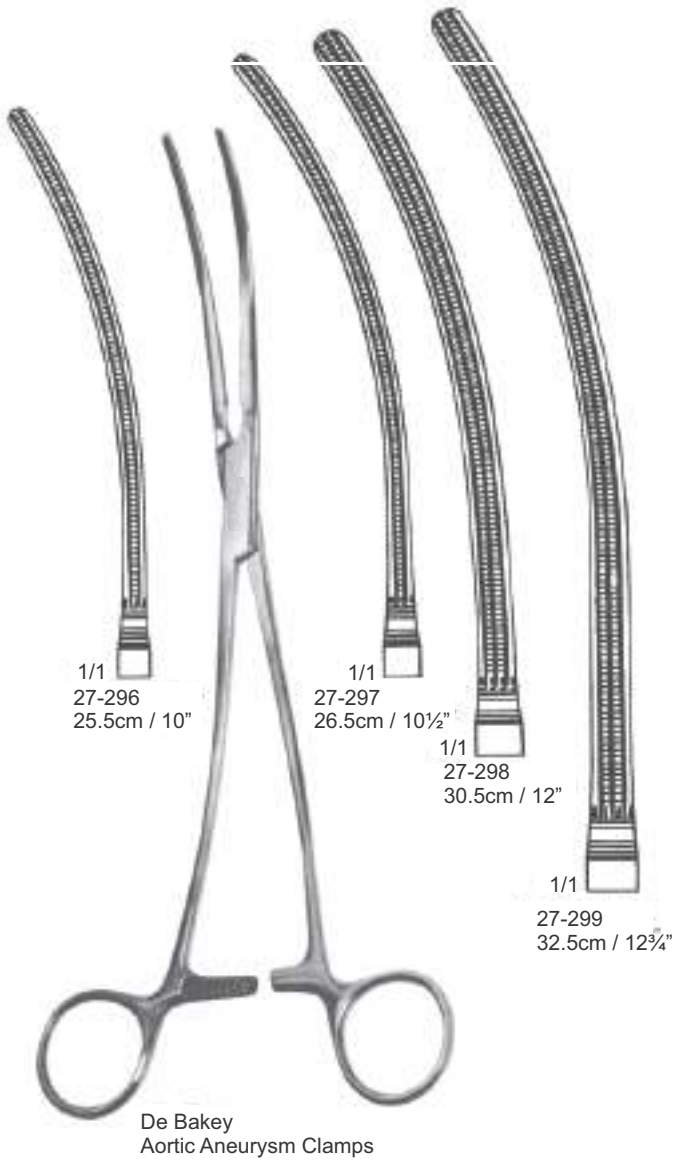

1/1  
27-296  
25.5cm / 10"

1/1  
27-297  
26.5cm / 10½"

1/1  
27-298  
30.5cm / 12"

1/1  
27-299  
32.5cm / 12¾"

De Bakey  
Aortic Aneurysm Clamps

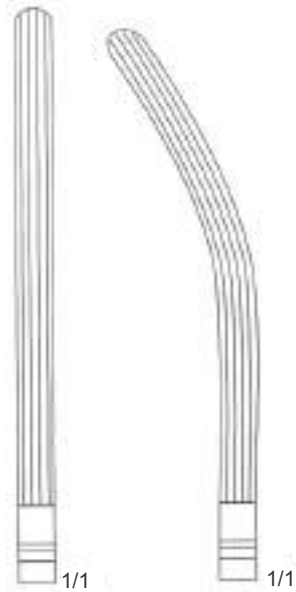

- Mayo-Robson(str)  
27-300 13cm / 5½"  
27-301 16cm / 6¼"  
27-302 18cm / 7"  
27-303 21cm / 8¼"  
27-304 23cm / 9"  
27-305 25cm / 10"  
Mayo-Robson(cur)  
27-306 13cm / 5½"  
27-307 16cm / 6¼"  
27-308 18cm / 7"  
27-309 21cm / 8¼"  
27-310 23cm / 9"  
27-311 25cm / 10"



1/1  
27-312  
14cm / 5½"

1/1  
27-313  
15.5cm / 6½"

1/1  
27-314  
16cm / 6¼"

De Bakey  
Multi-Purpose Forceps

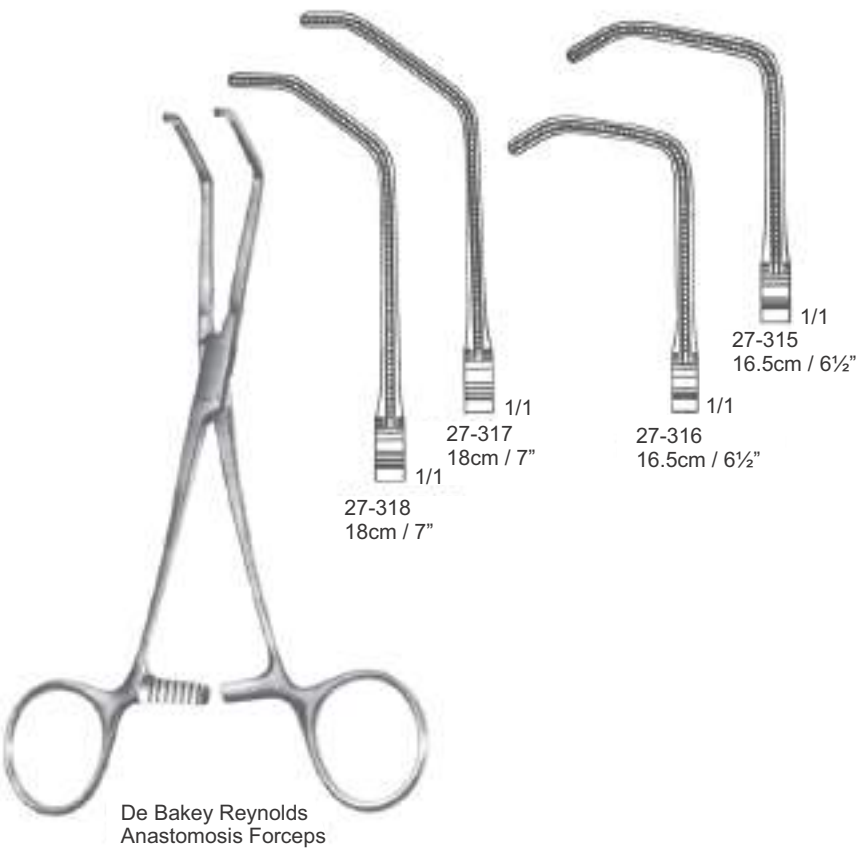

27-318  
18cm / 7"

1/1  
27-317  
18cm / 7"

1/1  
27-316  
16.5cm / 6½"

1/1  
27-315  
16.5cm / 6½"

De Bakey Reynolds  
Anastomosis Forceps

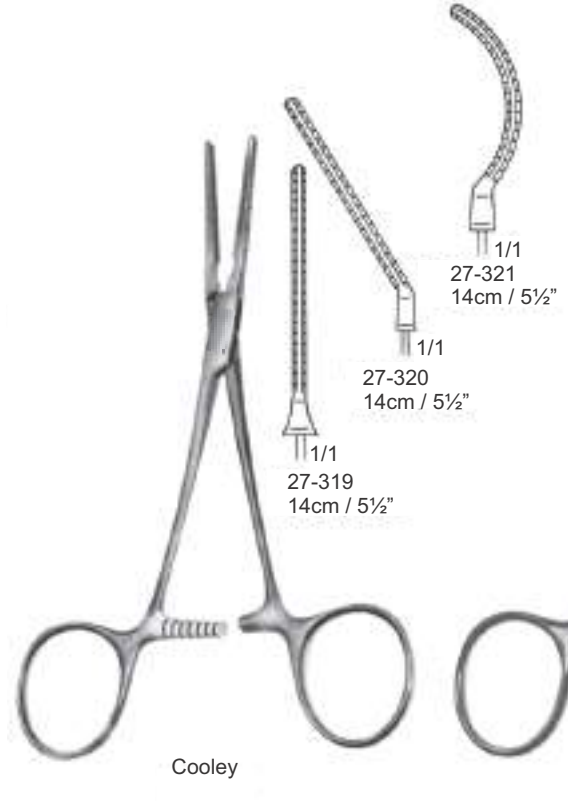

1/1  
27-320  
14cm / 5½"

1/1  
27-319  
14cm / 5½"

1/1  
27-321  
14cm / 5½"

Cooley

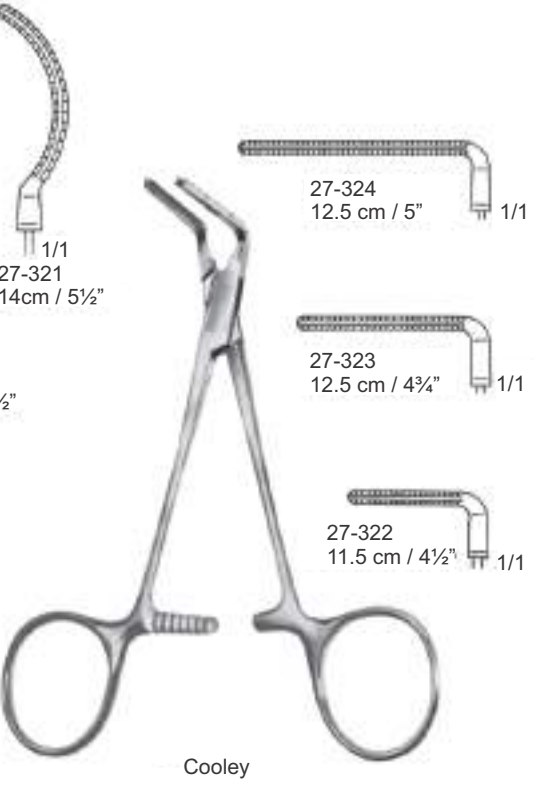

27-322  
11.5 cm / 4½"

27-323  
12.5 cm / 4¾"

27-324  
12.5 cm / 5"

Cooley

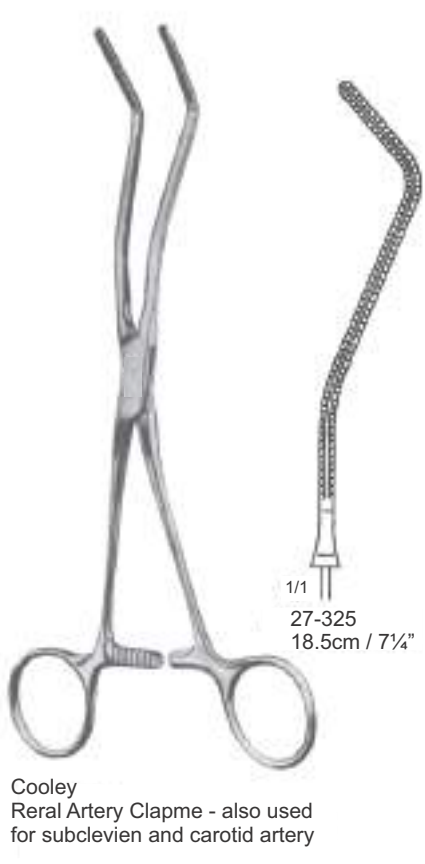

Cooley  
Reral Artery Clapme - also used  
for subclevien and carotid artery



Cooley  
Multi-Purpose Forceps,  
Angled 60°

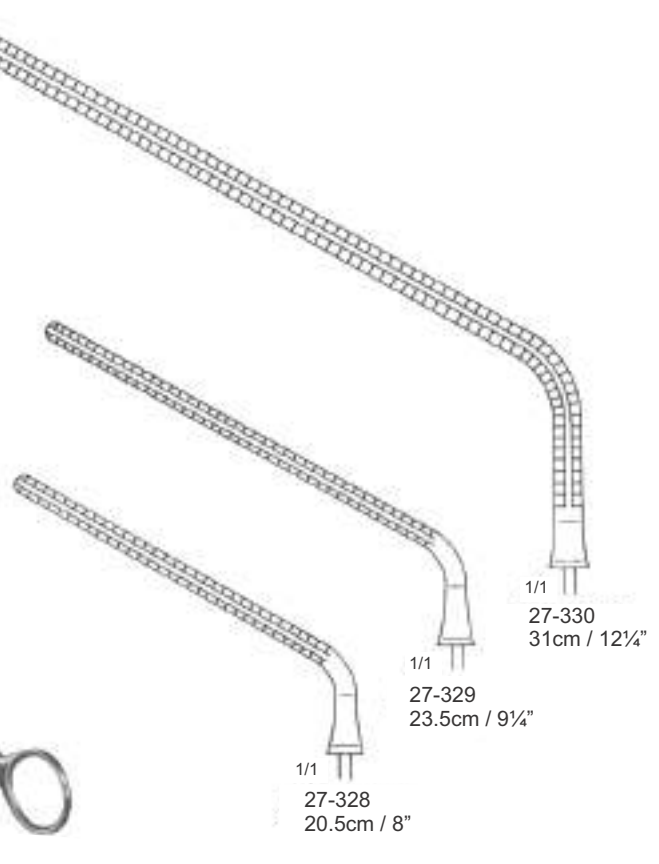

Yasargil  
20cm / 8"



Yasargil  
22.5cm / 8 7/8"

Yasargil  
22.5cm / 8 7/8"

Yasargil  
27-337  
24.5cm / 9 3/4"



Gluck  
27-338 16cm / 6 1/4"  
27-339 18cm / 7"  
27-340 20cm / 8"  
27-341 23cm / 9"



27-342  
Opening 12 cm / 4 3/4"  
Blades 28x32mm



Morse  
27-343 For Children  
With moveable double blades  
Opening 20 cm / 8"  
Blades 12 x 20 mm  
  
27-344 For Adults  
With moveable double blades  
Opening 20 cm / 8"  
Blades 19 x 19 mm



**Cooley**  
 27-345 For Newborns  
 27-346 Pediatric size  
 27-347 Pediatric size  
 27-348 For Adults

Opening	Blades
7.5cm / 3"	12x17mm
10cm / 4"	16x30mm
15cm / 6"	21x44mm
20cm / 8"	37x49mm



**Finochietto**  
 27-349 14cm / 4 1/4" 36x45mm  
 27-350 16.5cm / 6 1/2" 40x40mm  
 27-351 21cm / 8 1/4" 44x65mm  
 27-352 21cm / 8 1/4" 65x65mm  
 27-353 25cm / 10" 70x65mm  
 27-354 30cm / 12" 70x65mm

All available Aluminium as well.



**Burford**  
 For Infants: 27-360  
 For Adults: 27-361  
 For Adults: 27-362  
 For Adults: 27-363

Opening	Blades
13.5cm / 5 1/4"	34 x 42 mm & 48 x 42mm
18cm / 7"	47 x 62 mm & 65 x 62mm
26cm / 10 1/4"	47 x 62 mm & 65 x 62mm
30cm / 12"	47 x 62 mm & 65 x 62mm

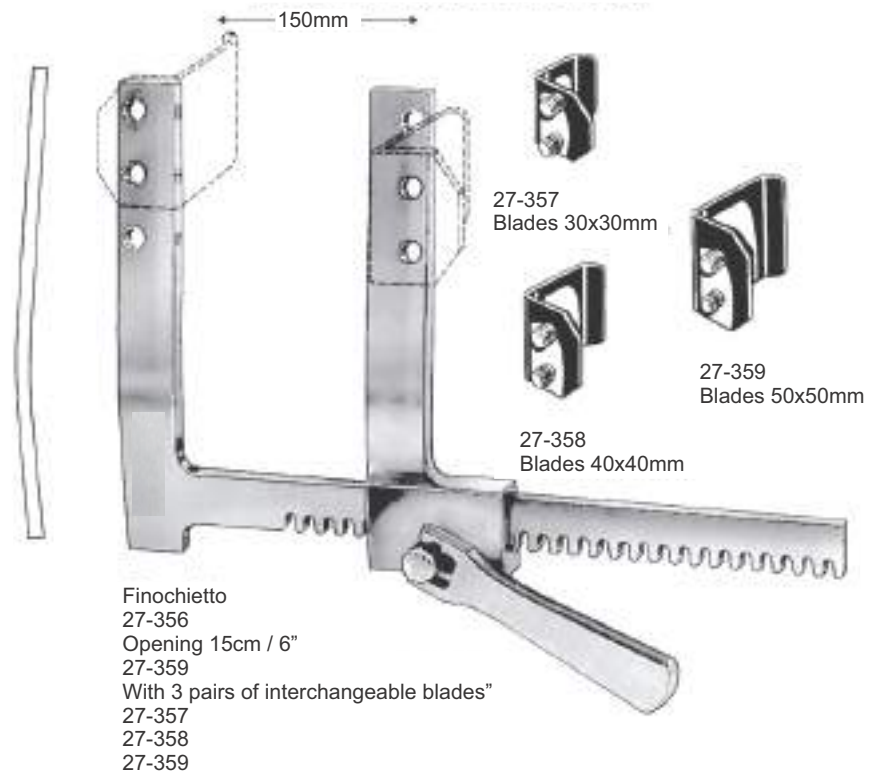

**Finochietto**  
 27-356  
 Opening 15cm / 6"  
 27-359  
 With 3 pairs of interchangeable blades"  
 27-357  
 27-358  
 27-359



Blades 48 x 42 mm  
 1/2  
 Blades 65 x 62 mm



With detachable weight

Auvard  
27-364  
75 x 38 mm



With fixed weight

Auvard  
27-365  
105 x 38 mm

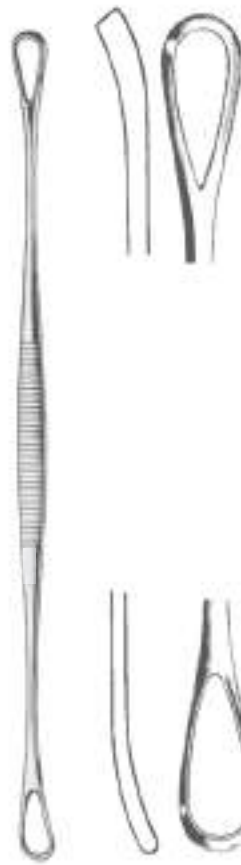

Zaufel(Blake)  
27-366  
31 cm / 12¼"



Simpson  
27-367  
23 cm / 9"



Watson Skin  
Graft Knife  
27-368  
30.5cm / 12"



1/2

Volkmann  
27-369 to 27-378  
18 cm / 7"

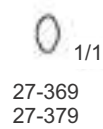

1/1  
27-369  
27-379



1/1  
27-370  
27-380



1/1  
27-371  
27-381



1/1  
27-372  
27-382



1/1  
27-373  
27-384



1/1  
27-374  
27-385

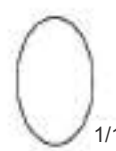

1/1  
27-375  
27-386



1/1  
27-376  
27-387



1/1  
27-377  
27-388

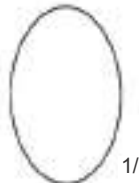

1/1  
27-378  
27-389



1/2

Volkmann  
27-379 to 27-389  
27 cm / 10½"

27-390  
Distractor Only, right

27-391  
Distractor Only, left



Caspar  
27-390 - 27-391

27-392  
Drill guide right  
for 27-390

27-393  
Drill guide left  
for 27-391



27-392 - 27-393

Twist drill Ø 1.7mm  
for distraction screws



27-394  
14.5 cm

Screw driver  
for distraction screws



27-395  
20 cm

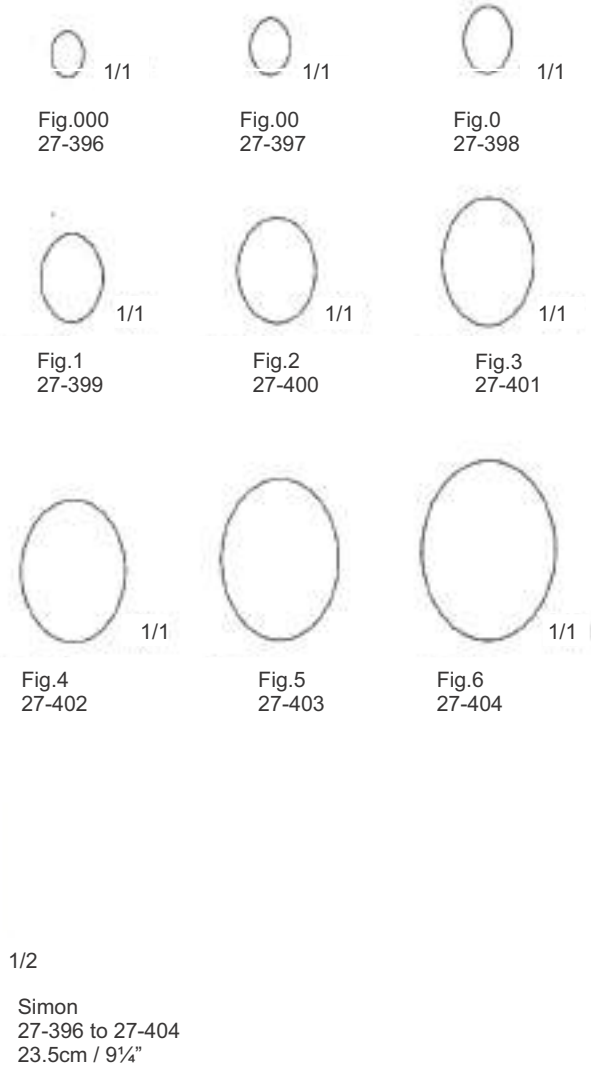

1/2  
Simon  
27-396 to 27-404  
23.5cm / 9 1/4"



1/2  
Kelly  
27-405 to 27-408  
26cm / 10 1/4"

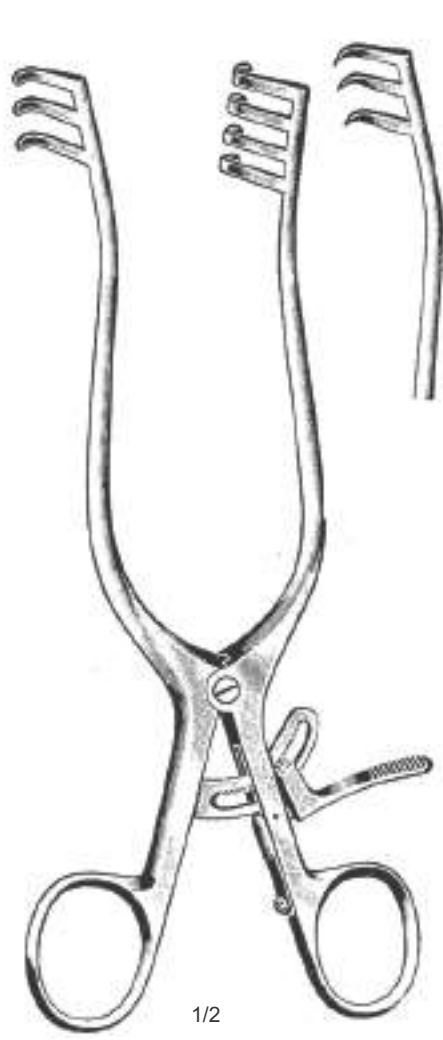

1/2  
weitlaner  
27-409 to 27-410  
20cm / 8"  
  
weitlaner  
27-411 to 27-414  
25cm / 10"

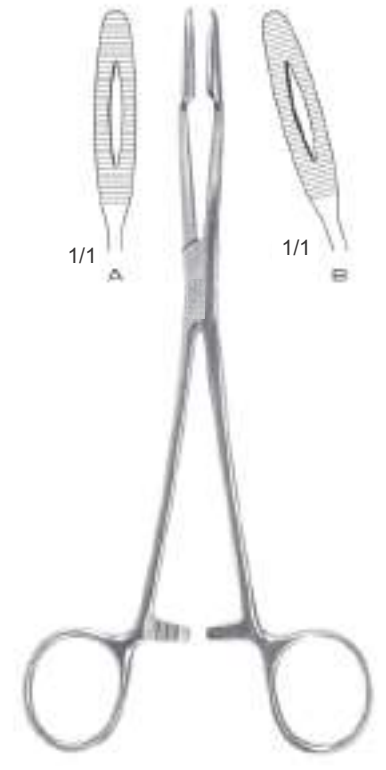
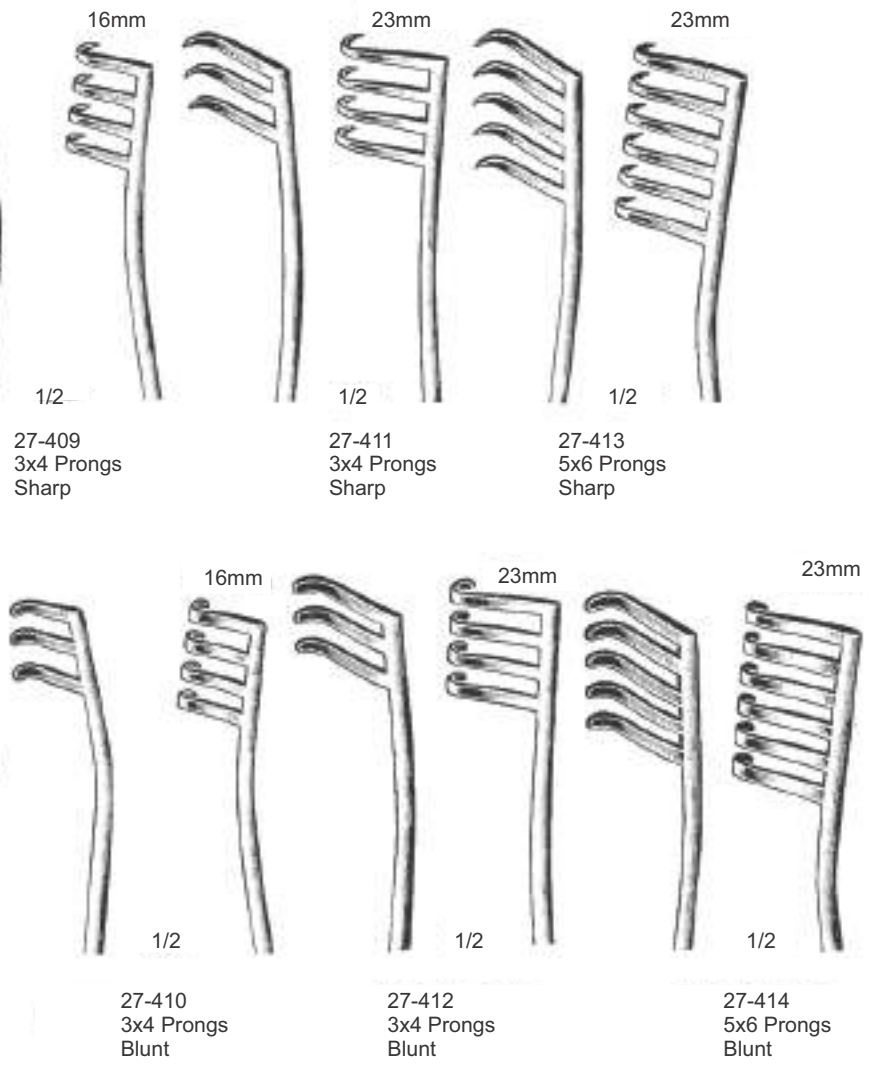

Gross-Maier	A	B
20 cm / 8"	27-415	27-419
22 cm / 8"	27-416	27-420
25 cm / 8"	27-417	27-421
27 cm / 8"	27-418	27-422





Heiss

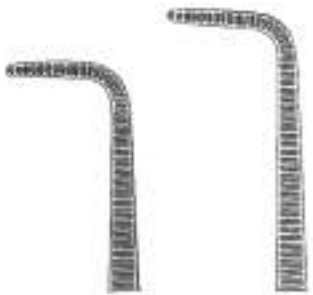

27-423  
20cm / 8"  
90°

27-424  
24cm / 9½"  
90°

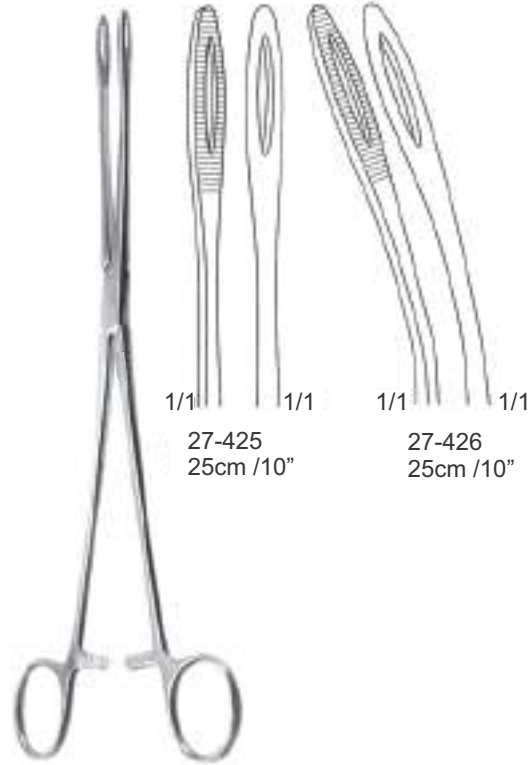

Foerster

1/1  
27-425  
25cm / 10"

1/1  
27-426  
25cm / 10"

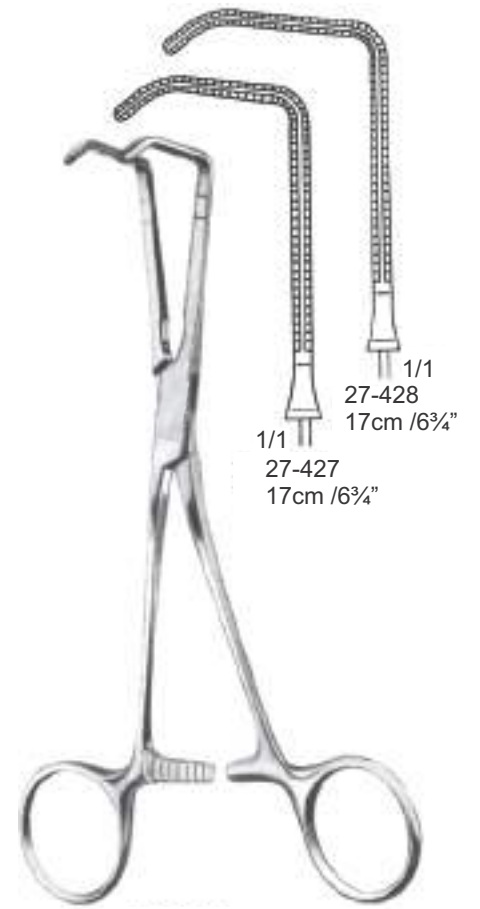

Cooley  
Anatomisoc Forceps

1/1  
27-428  
17cm / 6¾"

1/1  
27-427  
17cm / 6¾"

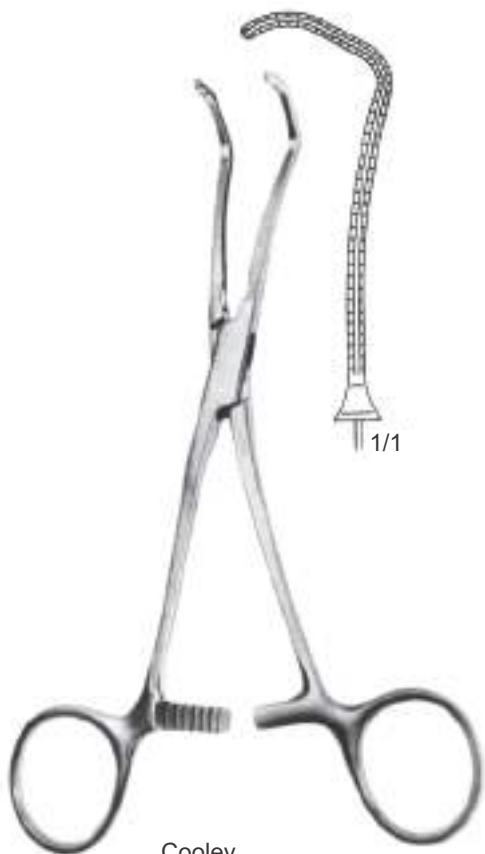

Cooley  
27-429  
17.5 cm / 7"  
Anatomisoc Forceps

1/1



Cooley  
angential Occlusion  
forceps

1/1  
27-430  
19.5cm / 7¾"

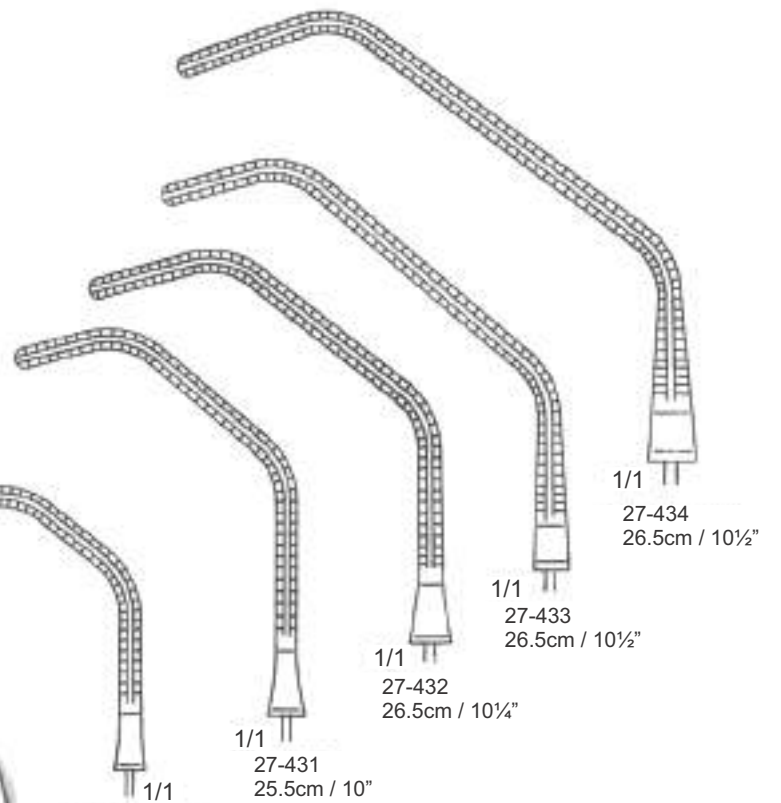

1/1  
27-431  
25.5cm / 10"

1/1  
27-432  
26.5cm / 10¼"

1/1  
27-433  
26.5cm / 10½"

1/1  
27-434  
26.5cm / 10½"

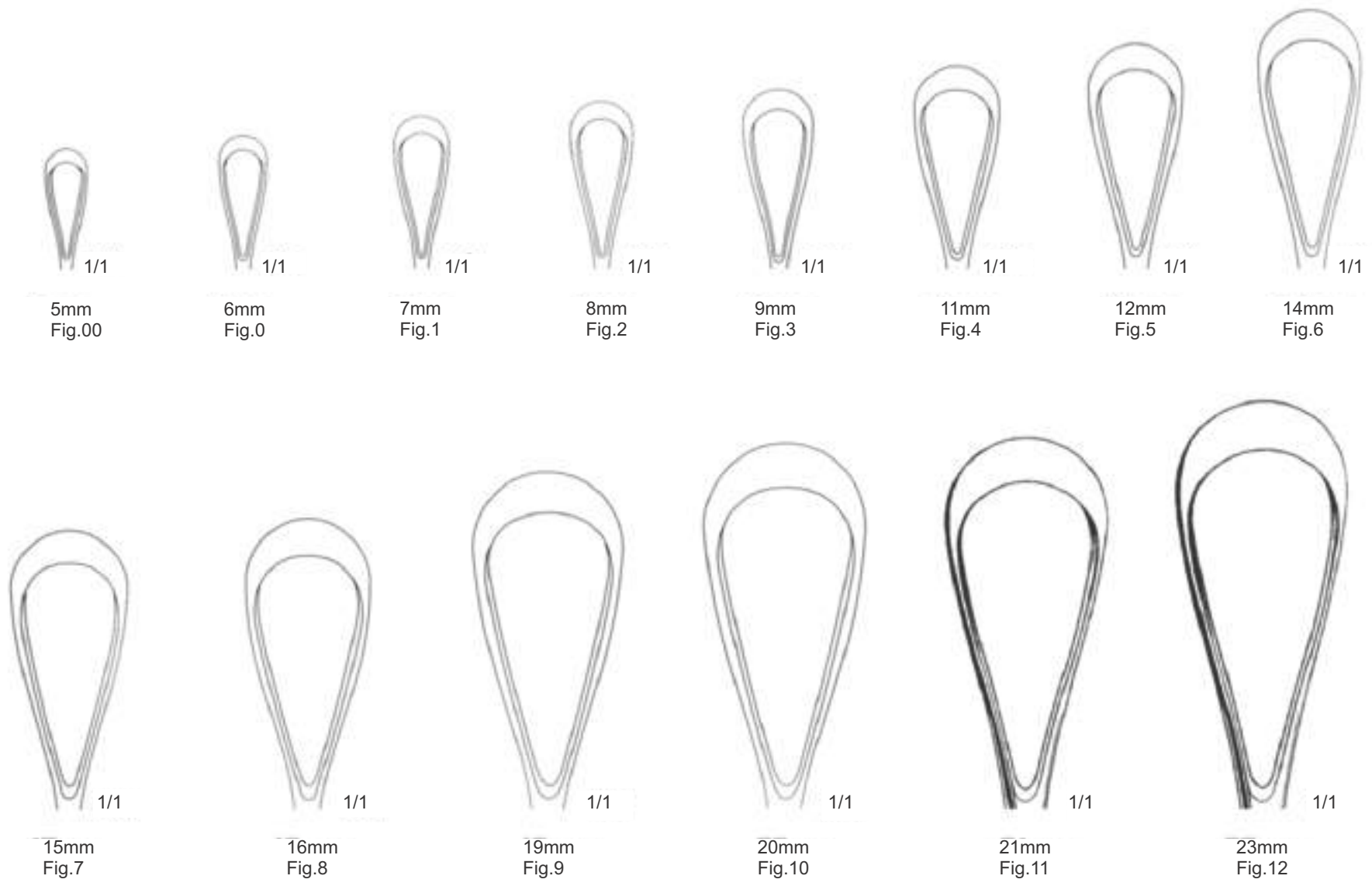

Sharp,rigid

26 cn / 10¼" 31 cm / 12¼"

Fig.00	27-435	27-449
Fig.0	27-436	27-450
Fig.1	27-437	27-451
Fig.2	27-438	27-452
Fig.3	27-439	27-453
Fig.4	27-440	27-454
Fig.5	27-441	27-455
Fig.6	27-442	27-456
Fig.7	27-443	27-457
Fig.8	27-444	27-458
Fig.9	27-445	27-459
Fig.10	27-446	27-460
Fig.11	27-447	27-461
Fig.12	27-448	27-462

Recamier



Sharp,malleable

26 cn / 10¼" 31 cm / 12¼"

Fig.00	27-463	27-477
Fig.0	27-464	27-478
Fig.1	27-465	27-479
Fig.2	27-466	27-480
Fig.3	27-467	27-481
Fig.4	27-468	27-482
Fig.5	27-469	27-483
Fig.6	27-470	27-484
Fig.7	27-471	27-485
Fig.8	27-472	27-486
Fig.9	27-473	27-487
Fig.10	27-474	27-488
Fig.11	27-475	27-489
Fig.12	27-476	27-490

Recamier

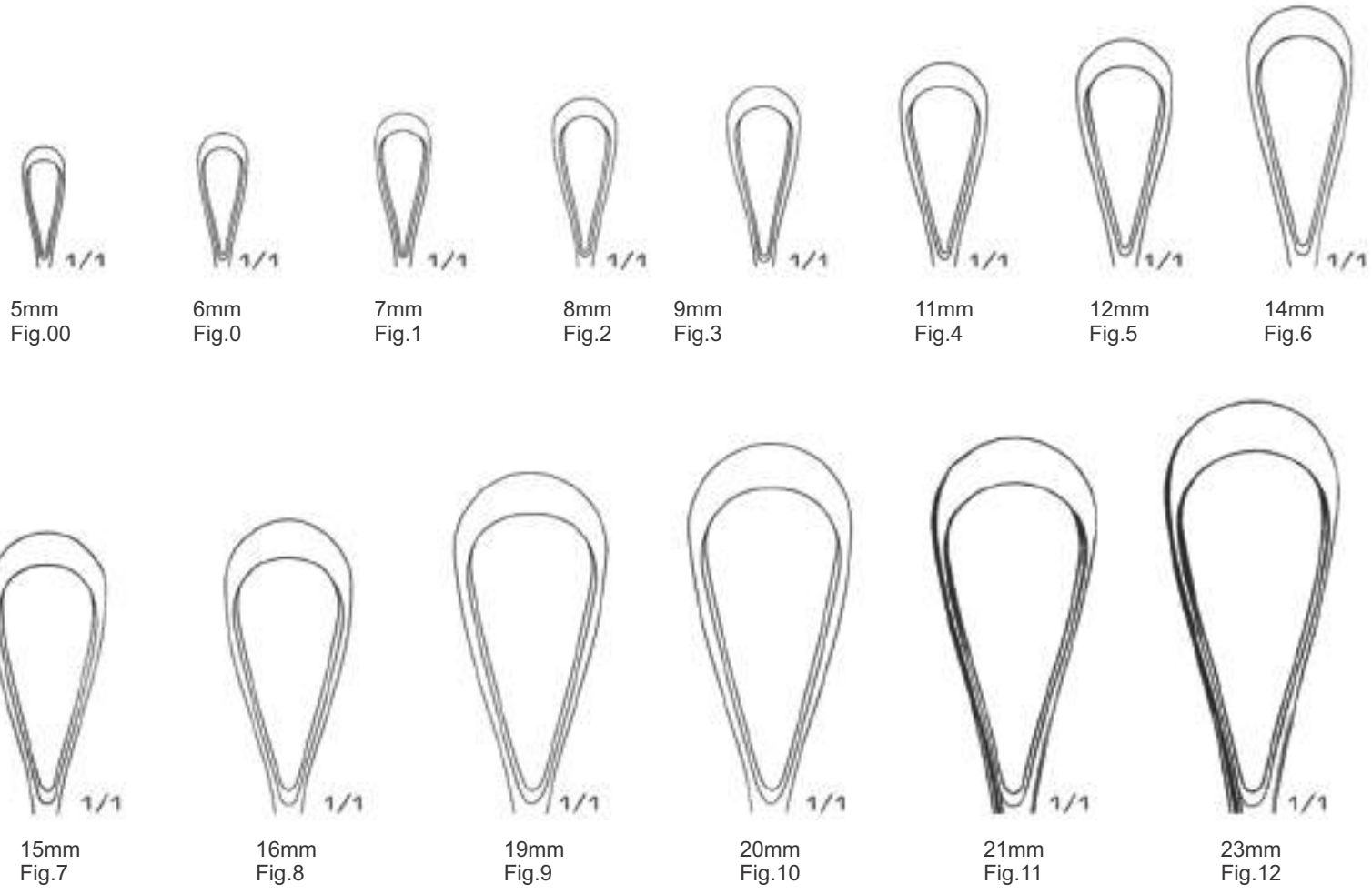

Blunt, malleable

26 cm / 10 1/4" 31 cm / 12 1/4"

Fig.00	27-491	27-505
Fig.0	27-492	27-506
Fig.1	27-493	27-507
Fig.2	27-494	27-508
Fig.3	27-495	27-509
Fig.4	27-496	27-510
Fig.5	27-497	27-511
Fig.6	27-498	27-512
Fig.7	27-499	27-513
Fig.8	27-500	27-514
Fig.9	27-501	27-515
Fig.10	27-502	27-516
Fig.11	27-503	27-517
Fig.12	27-504	27-518

Sims



Casper  
27-519 to 27-566



27-519 Shaft 12.5cm / 5"  
27-520 Shaft 14cm / 5½"  
27-521 Shaft 16cm / 6¼"  
27-522 Shaft 18.5cm / 7¼"  
2 x 10 mm



27-523 Shaft 12.5cm / 5"  
27-524 Shaft 14cm / 5½"  
27-525 Shaft 16cm / 6¼"  
27-526 Shaft 18.5cm / 7¼"  
2 x 10 mm



27-527 Shaft 12.5cm / 5"  
27-528 Shaft 14cm / 5½"  
27-529 Shaft 16cm / 6¼"  
27-530 Shaft 18.5cm / 7¼"  
2 x 10 mm



27-531 Shaft 12.5cm / 5"  
27-532 Shaft 14cm / 5½"  
27-533 Shaft 16cm / 6¼"  
27-534 Shaft 18.5cm / 7¼"  
3 x 10 mm

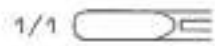

27-535 Shaft 12.5cm / 5"  
27-536 Shaft 14cm / 5½"  
27-537 Shaft 16cm / 6¼"  
27-538 Shaft 18.5cm / 7¼"  
3 x 10 mm



27-539 Shaft 12.5cm / 5"  
27-540 Shaft 14cm / 5½"  
27-541 Shaft 16cm / 6¼"  
27-542 Shaft 18.5cm / 7¼"  
3 x 10 mm



27-543 Shaft 12.5cm / 5"  
27-544 Shaft 14cm / 5½"  
27-545 Shaft 16cm / 6¼"  
27-546 Shaft 18.5cm / 7¼"  
4 x 10 mm



27-547 Shaft 12.5cm / 5"  
27-548 Shaft 14cm / 5½"  
27-549 Shaft 16cm / 6¼"  
27-550 Shaft 18.5cm / 7¼"  
4 x 10 mm



27-551 Shaft 12.5cm / 5"  
27-552 Shaft 14cm / 5½"  
27-553 Shaft 16cm / 6¼"  
27-554 Shaft 18.5cm / 7¼"  
4 x 10 mm



27-555 Shaft 12.5cm / 5"  
27-556 Shaft 14cm / 5½"  
27-557 Shaft 16cm / 6¼"  
27-558 Shaft 18.5cm / 7¼"  
5 x 10 mm



27-559 Shaft 12.5cm / 5"  
27-560 Shaft 14cm / 5½"  
27-561 Shaft 16cm / 6¼"  
27-562 Shaft 18.5cm / 7¼"  
5 x 10 mm



27-563 Shaft 12.5cm / 5"  
27-564 Shaft 14cm / 5½"  
27-565 Shaft 16cm / 6¼"  
27-566 Shaft 18.5cm / 7¼"  
4 x 10 mm

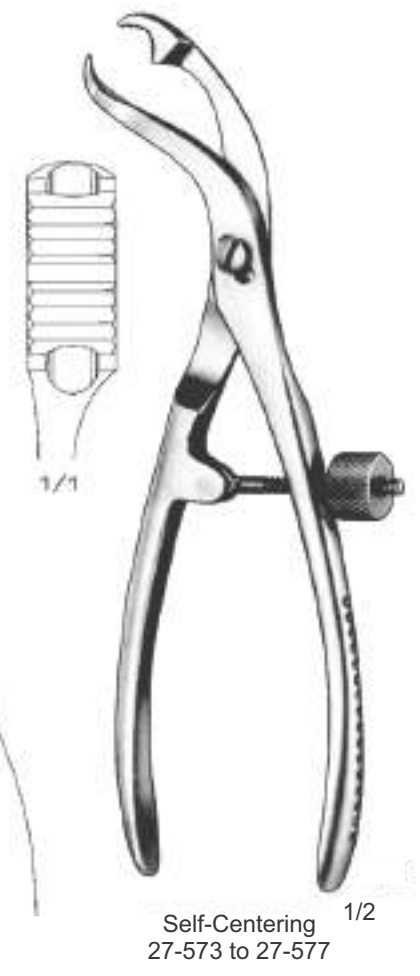
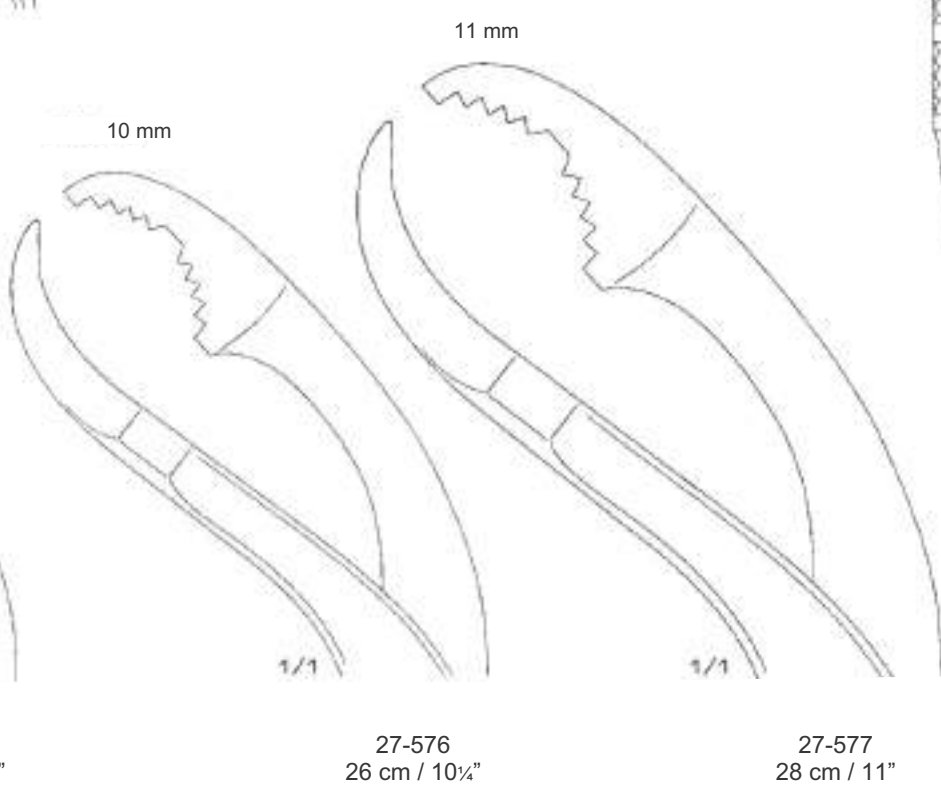
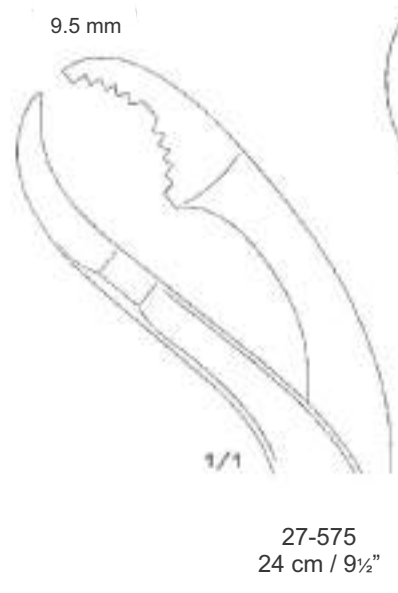
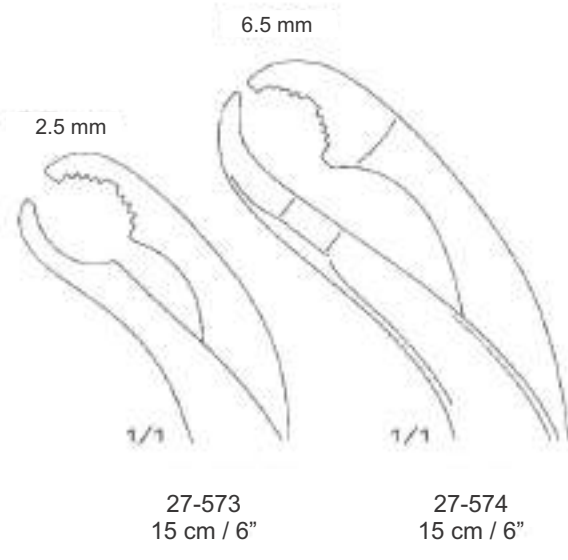
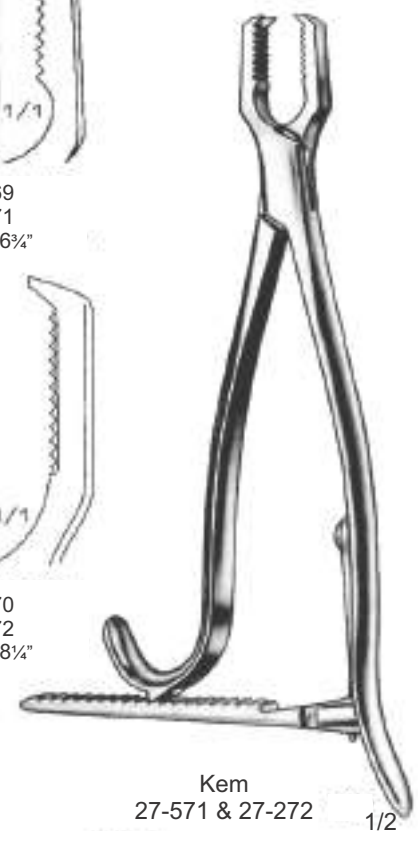
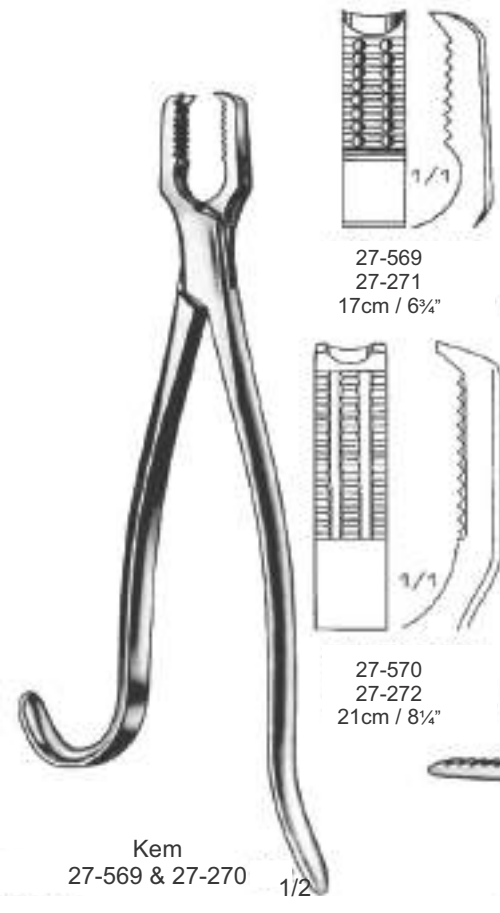
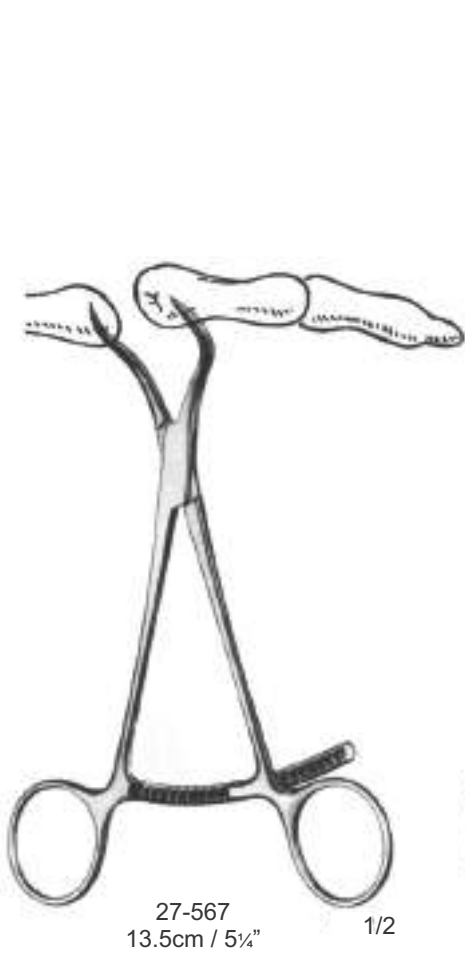

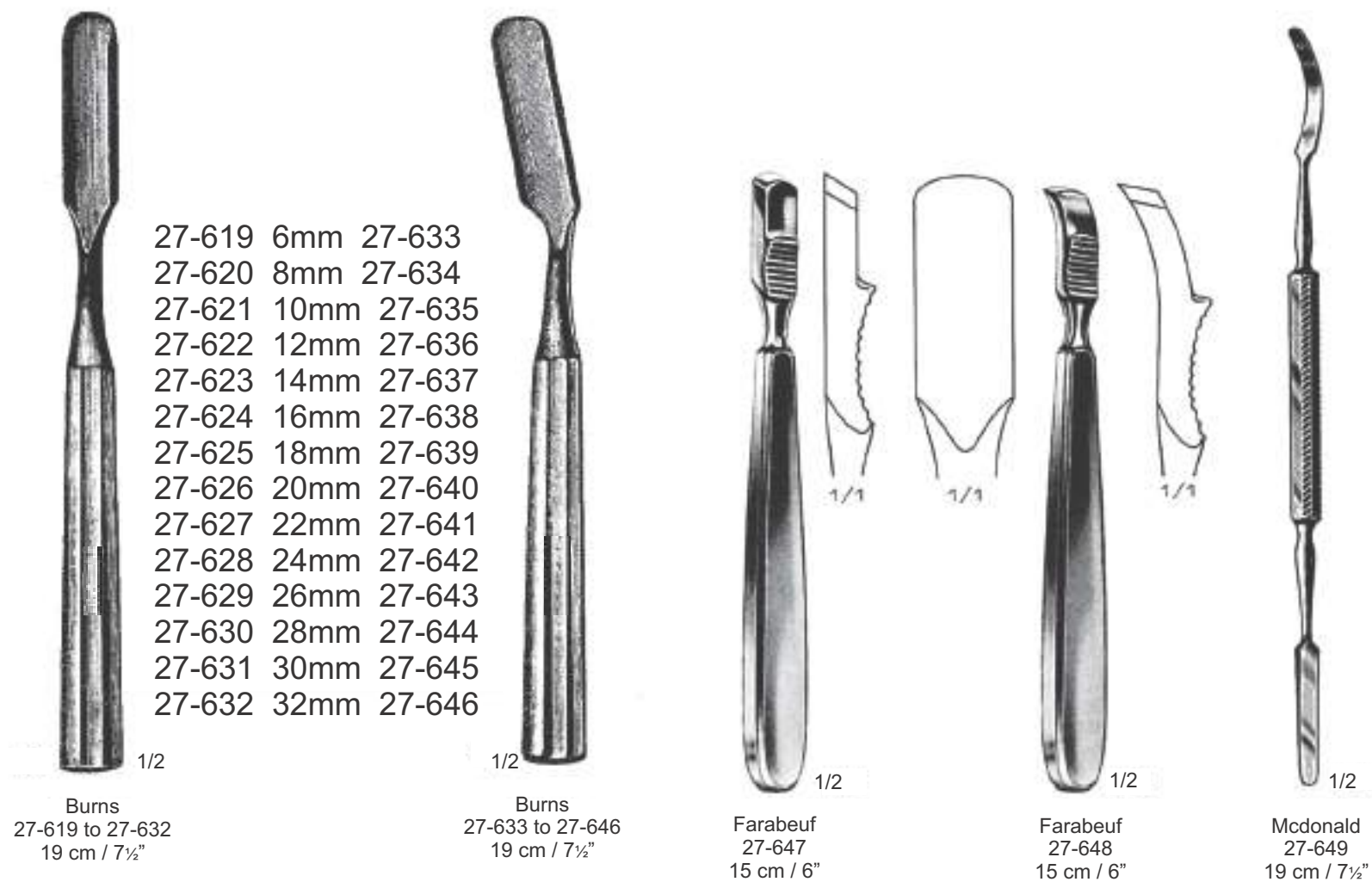
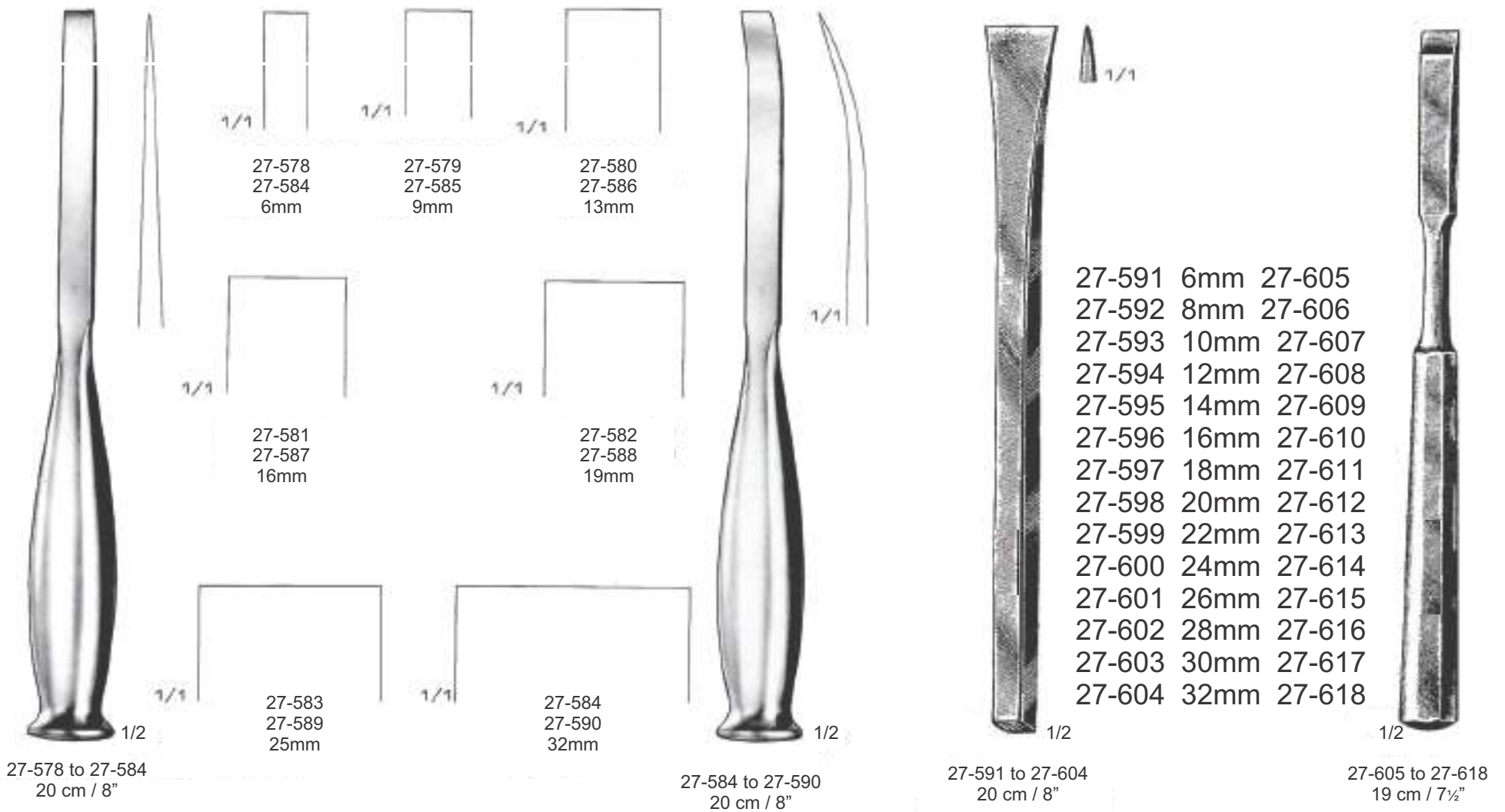



Hohmann  
27-650  
25 cm / 10"

Hohmann  
27-651  
28 cm / 11"

Hohmann  
27-652  
27 cm / 10½"

Lange-Hohmann  
27-653  
25 cm / 10"

Wagner  
27-654  
25 cm / 8¾"

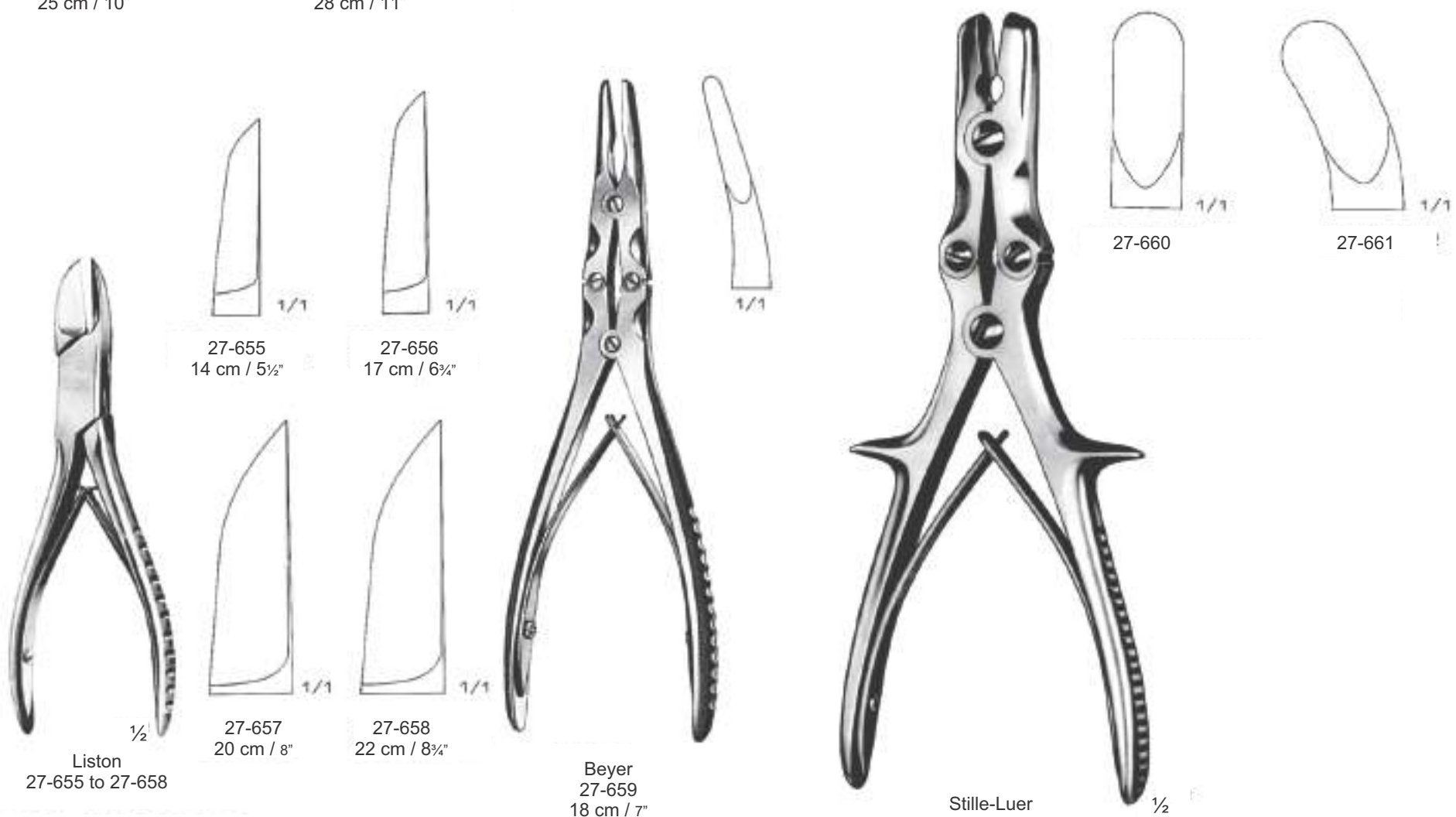

Liston  
27-655 to 27-658

27-655  
14 cm / 5½"

27-656  
17 cm / 6¾"

27-657  
20 cm / 8"

27-658  
22 cm / 8¾"

Beyer  
27-659  
18 cm / 7"

Stille-Luer  
27-660 to 27-661  
22 cm / 8¾"







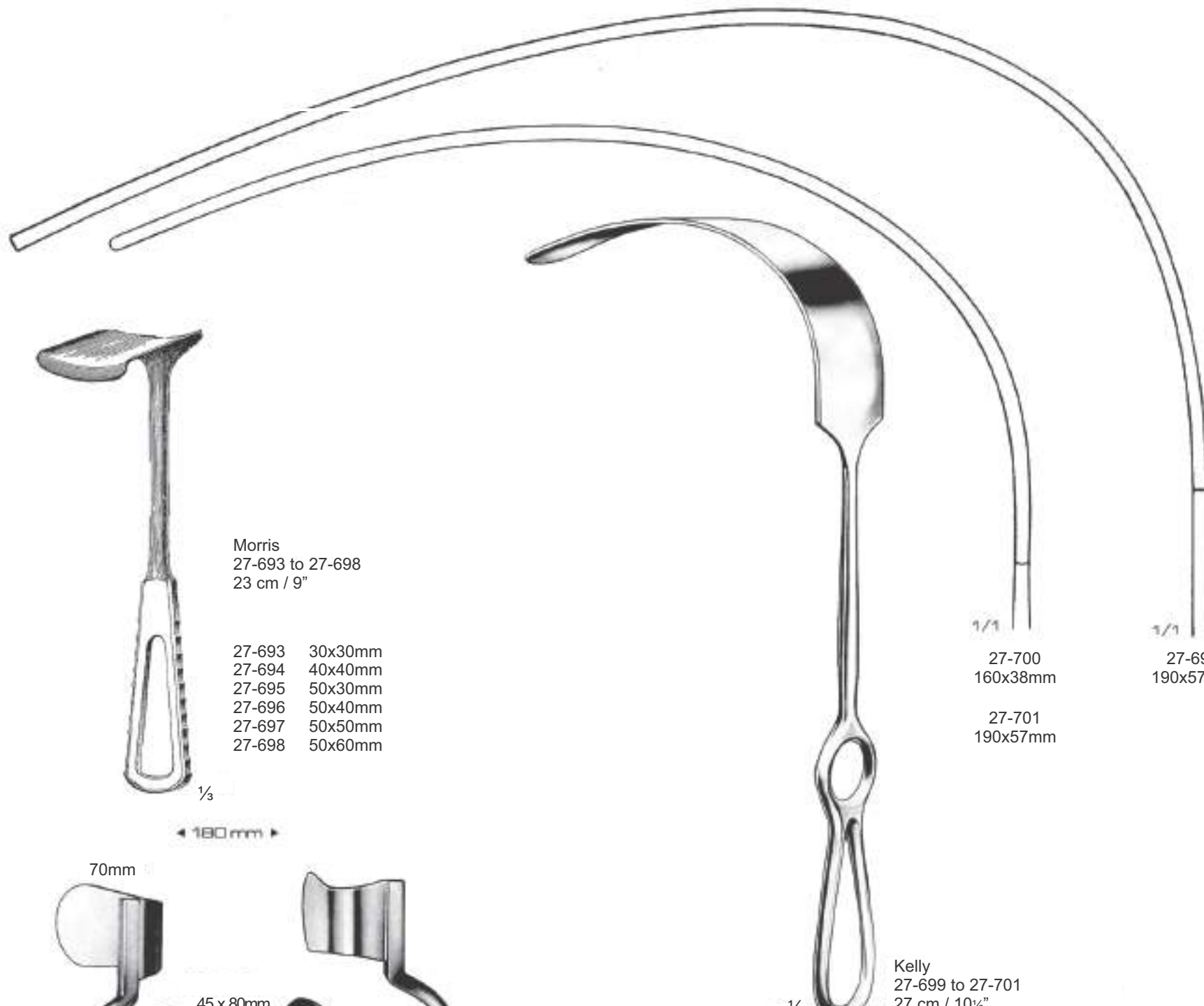

Morris  
27-693 to 27-698  
23 cm / 9"

- 27-693 30x30mm
- 27-694 40x40mm
- 27-695 50x30mm
- 27-696 50x40mm
- 27-697 50x50mm
- 27-698 50x60mm

27-700 160x38mm  
27-701 190x57mm

27-699 190x57mm

Kelly  
27-699 to 27-701  
27 cm / 10½"

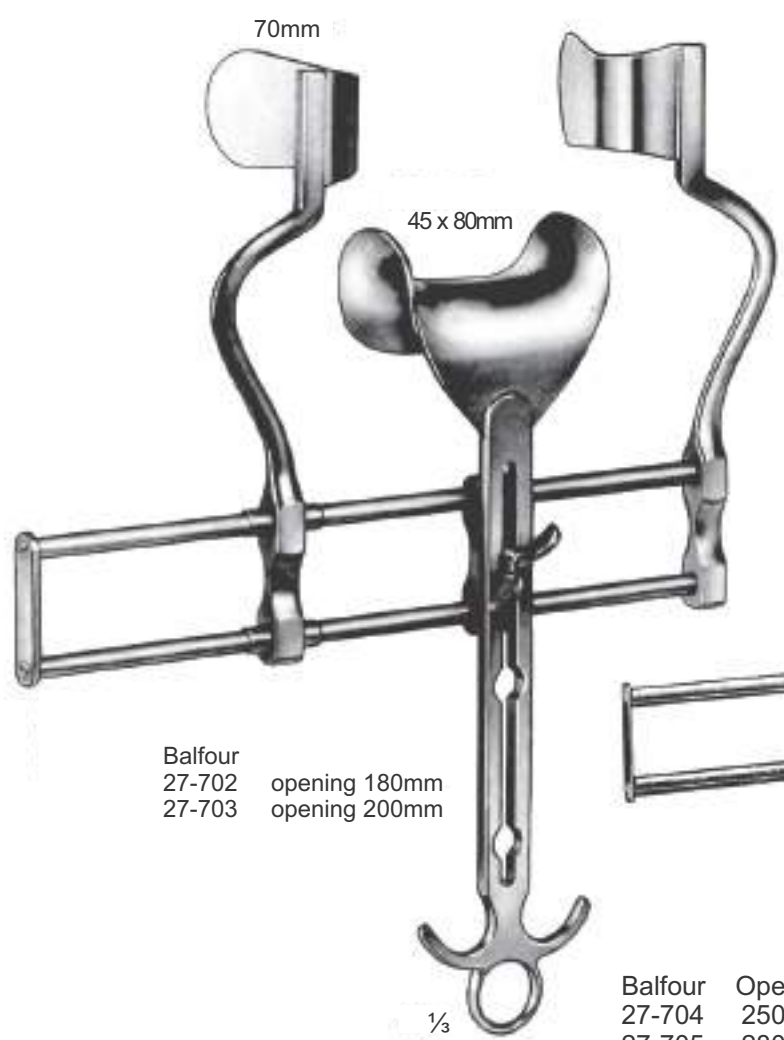

Balfour  
27-702 opening 180mm  
27-703 opening 200mm

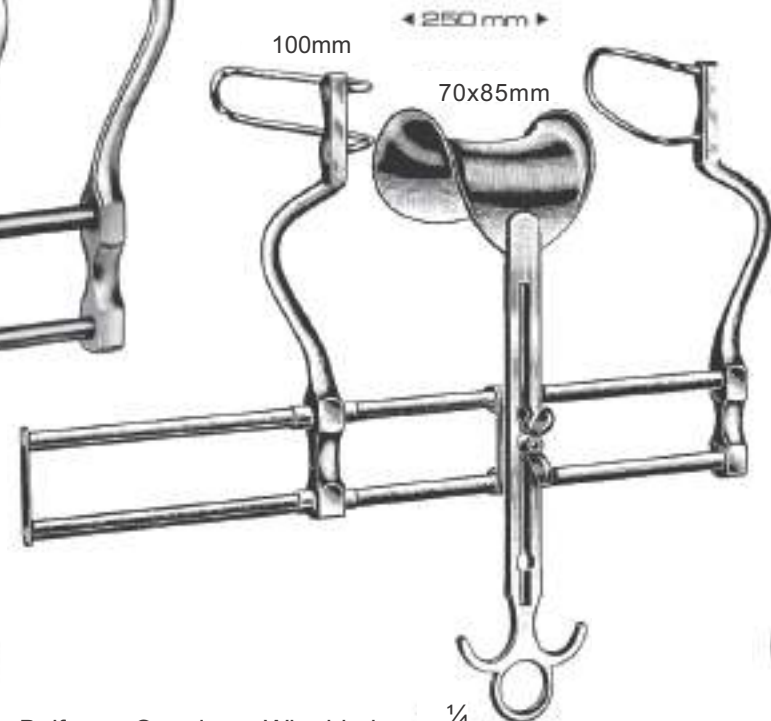

Balfour	Opening	Wire blades
27-704	250mm	35 x 100mm
27-705	280mm	40 x 105mm
27-706	300mm	40 x 110mm

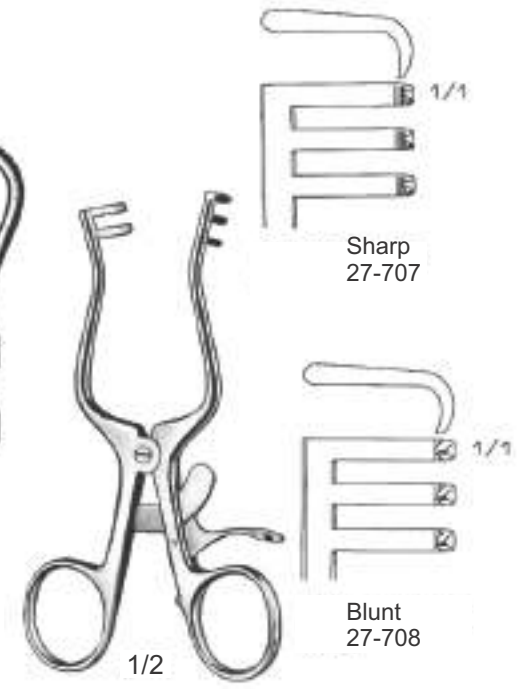

Sharp  
27-707

Blunt  
27-708

Weitlaner-Loktite  
27-707 & 27-708  
10.5 cm / 4¼"  
2 x 3 Prongs



Weitlaner-Wullstein  
27-709 & 27-710  
13 cm / 5 1/4"  
3 x 3 Prongs



Sharp  
27-709

Blunt  
27-710

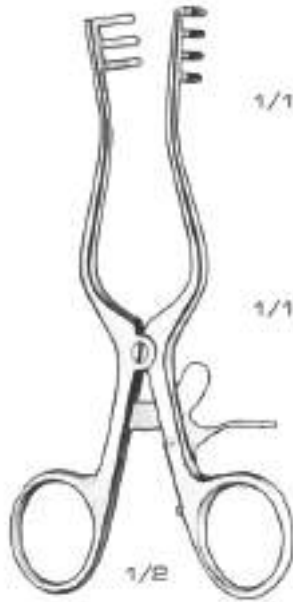

27-711 & 27-712  
13 cm / 5 1/8"  
3 x 4 Prongs

27-713 & 27-714  
16.5 cm / 6 1/2"  
3 x 4 Prongs

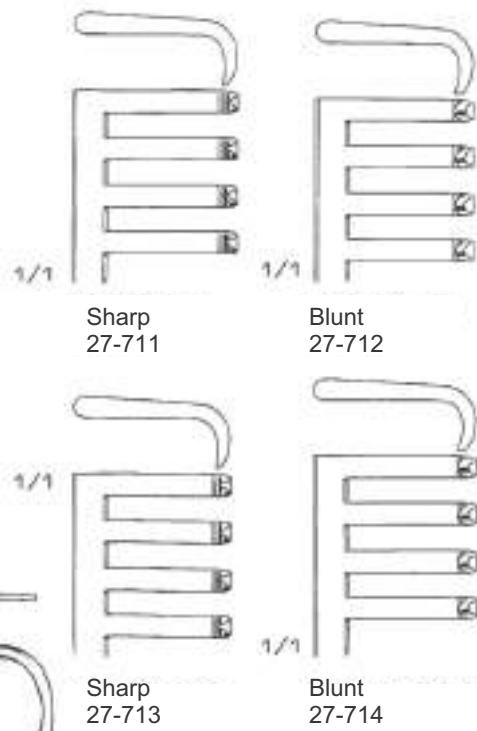

Sharp  
27-711

Blunt  
27-712

Sharp  
27-713

Blunt  
27-714

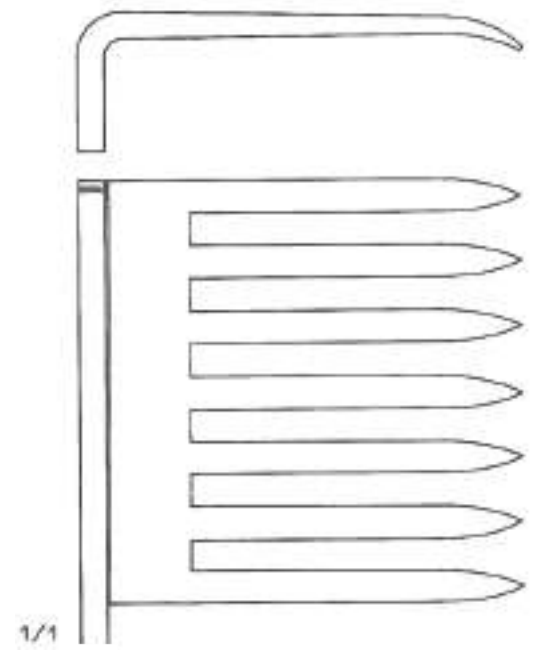

1/1



Beckmann-Eaton  
27-725  
7 x 7 Prongs  
Semi-Sharp



27-715  
16 x 40mm



27-716  
16 x 45mm



27-717  
16 x 50mm



27-718  
16 x 55mm



27-719  
16 x 60mm



Cloward Modif.  
27-715 to 27-724  
25 cm / 10"



27-720  
16 x 40mm



27-721  
16 x 45mm



27-722  
16 x 50mm



27-723  
16 x 55mm



27-724  
16 x 80mm

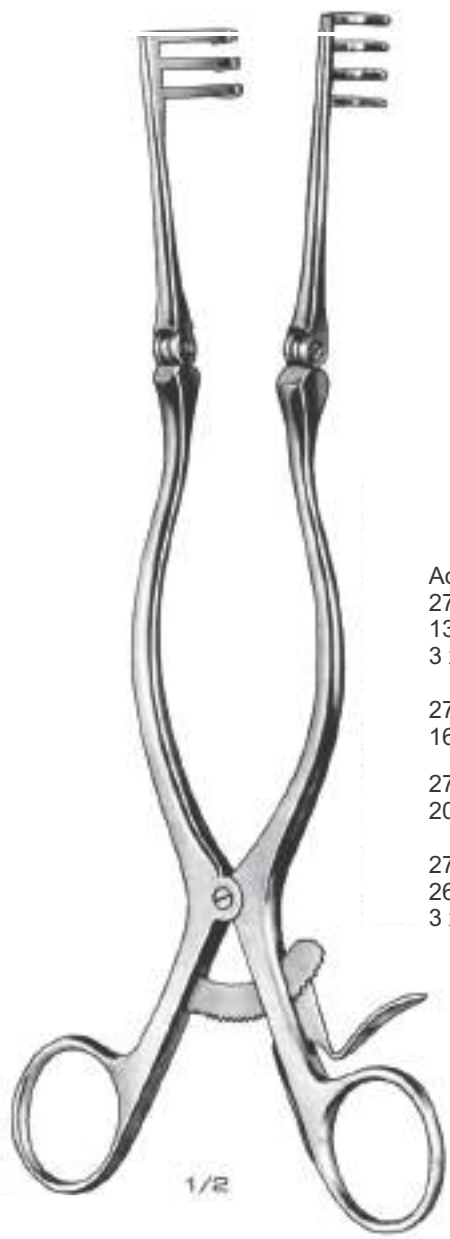

Adson  
27-726 & 27-727  
13 cm / 5"  
3 x 4 Prongs

27-728 & 27-729  
16 cm / 6 1/4"  
3 x 4 Prongs

27-730 & 27-731  
20 cm / 8"  
3 x 4 Prongs

27-732 & 27-733  
26 cm / 10 1/4"  
3 x 4 Prongs

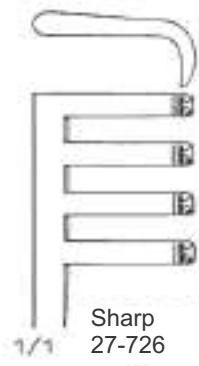

Sharp  
27-726

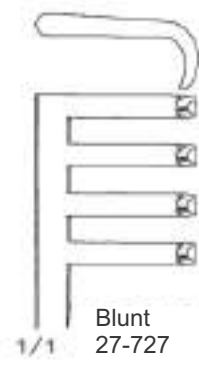

Blunt  
27-727

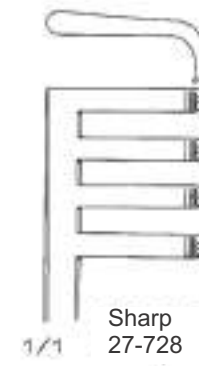

Sharp  
27-728

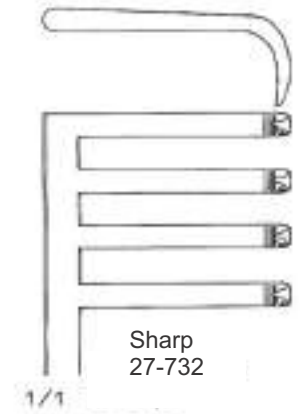

Sharp  
27-732

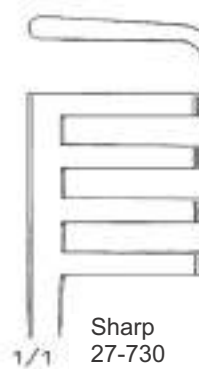

Sharp  
27-730



Blunt  
27-731

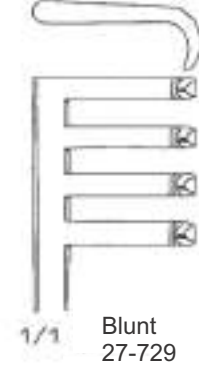

Blunt  
27-729

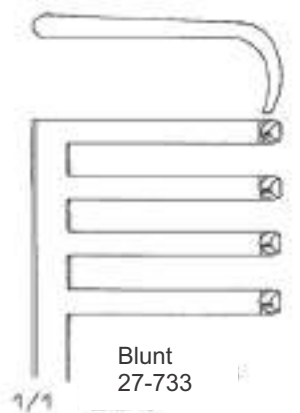

Blunt  
27-733

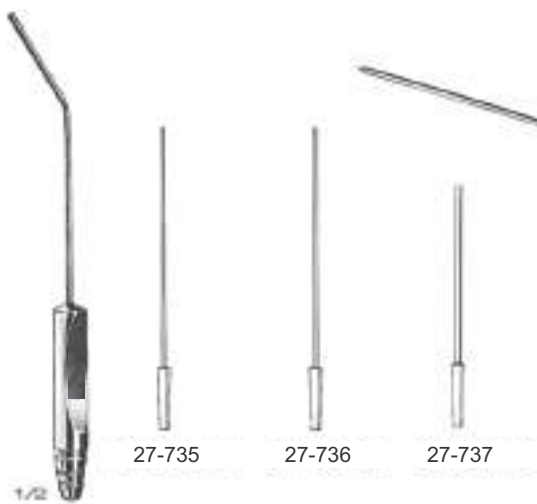

Wullstein  
27-734  
14 cm / 5 1/2"

27-738 Micro Suction tube, complete, consisting:  
27-739 -Suction tube with Luer hub  
27-740 -Micro suction cannula, ø 0.4mm  
27-741 -ditto ø 0.6mm  
27-742 -ditto ø 0.8mm

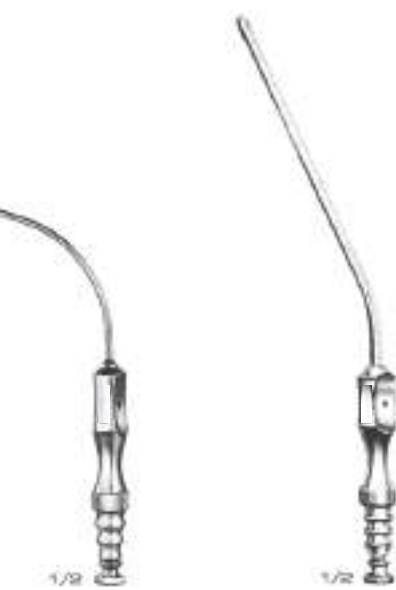

Poppen  
27-743 to 27-746  
13 cm / 5"  
Charn / Fn

6 27-743  
8 27-744  
10 27-745  
12 27-746

Frazier  
27-747 to 27-750  
19 cm / 7 1/2"  
Charn / Fn

6 27-747  
8 27-748  
10 27-749  
12 27-750



Fig-0  
27-752



Fig-1  
27-753



Fig-2  
27-754



Fig-3  
27-755



Yankaur  
27-751 to 27-757  
14 cm / 5 1/2"



Yankaur  
27-758  
27 cm / 11"



Also available in Non-Magnet Stainless Steel (18/8-304)



27-798  
12.5 cm / 5"  
No.3

27-799  
12.5 cm / 5"  
No.3

27-800  
21 cm / 8 1/4"  
No.3L

27-801  
20 cm / 8"  
No.3L

27-802  
13.5 cm / 5 1/4"  
No.4

27-803  
21 cm / 8 1/4"  
No.4L

27-804  
20 cm / 8"  
No.4L



Micro-Adson  
27-805  
15cm / 6"



Potts-Smith  
27-806 18 cm / 7"  
27-807 21cm / 8¼"  
27-808 25cm / 10"



Allis-Baby  
27-809 15cm / 6" (4x5 th)  
27-810 19cm / 7½" (5x6 th)  
27-811 25cm / 10" (6x5 th)



Halsey  
13cm / 5 1/8"



27-812

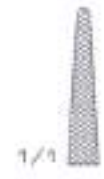

27-813

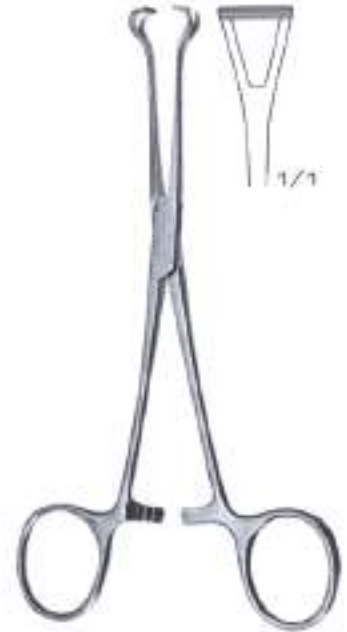

Babcock  
27-814  
16cm / 6¼"

27-815  
18cm / 7"

27-816  
20cm / 8"

27-817  
24cm / 9½"



Mayo-Hegar

27-821  
20cm / 8"

27-822  
24cm / 9½"

27-823  
26cm / 10¼"

27-824  
30cm / 12"

27-818  
14cm / 5½"

27-819  
16cm / 6¼"

27-820  
18cm / 7"

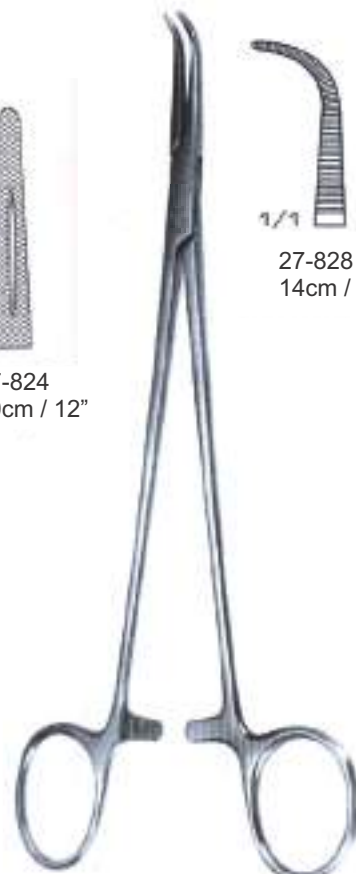

Gemini

27-828  
14cm / 5½"

27-829  
16cm / 6¼"

27-830  
18cm / 7"

27-831  
20cm / 8"

27-825  
23cm / 9"

27-826  
25cm / 10"

27-827  
28cm / 11"

Ø2.0mm



- |               |        |
|---------------|--------|
| 11.5 cm / 4½" | 27-832 |
| 13.5 cm / 5⅛" | 27-833 |
| 14.5 cm / 5¾" | 27-834 |
| 16 cm / 6¼"   | 27-835 |
| 18 cm / 7"    | 27-836 |
| 20cm / 8"     | 27-837 |
| 25 cm / 10"   | 27-838 |



27-839  
13cm / 5⅛"



27-840  
16cm / 6¼"

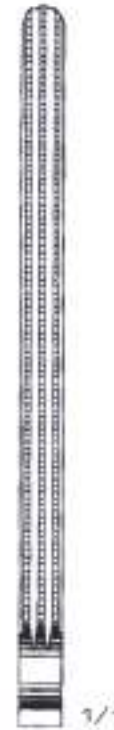

27-841  
18cm / 7"



27-842  
21cm / 8¼"



27-843  
23cm / 9"



Castroviejo



27-844  
14cm / 5½"



27-845  
18cm / 7"



27-846  
20cm / 8"



27-847  
14cm / 5½"



27-848  
18cm / 7"



27-849  
20cm / 8"



Doyen



27-850  
13cm / 8⅛"



27-851  
16cm / 6¼"



27-852  
18cm / 7"



27-853  
21cm / 8¼"



27-854  
23cm / 9"



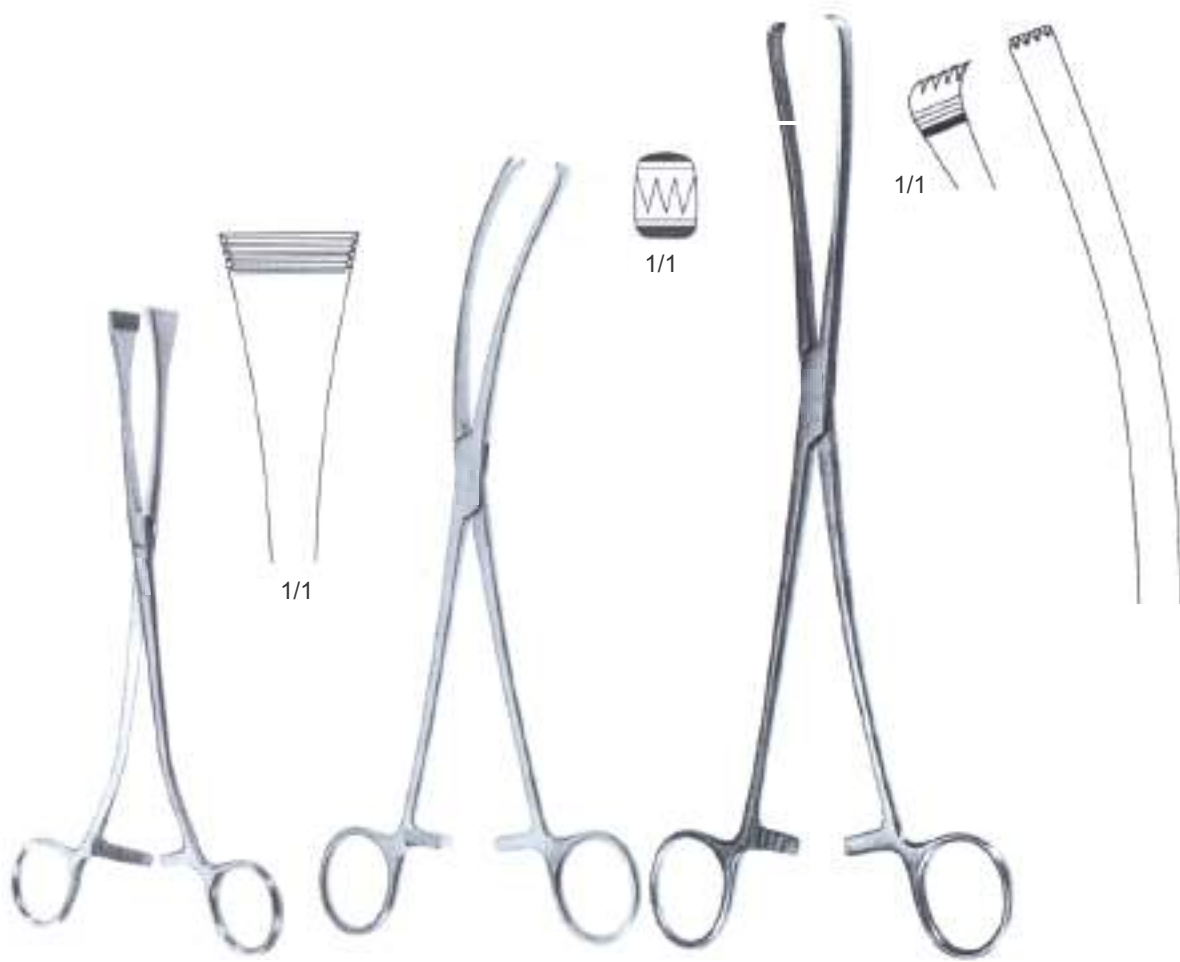

Green-Armytage  
27-855  
21 cm / 8 1/4"

Teale  
27-856  
23 cm / 9"

Lova  
27-857  
26 cm / 10 1/4"



central fixation screw

Cusco  
75x32 mm 27-858  
85x36mm 27-859  
95x37mm 27-860  
Also available in black color

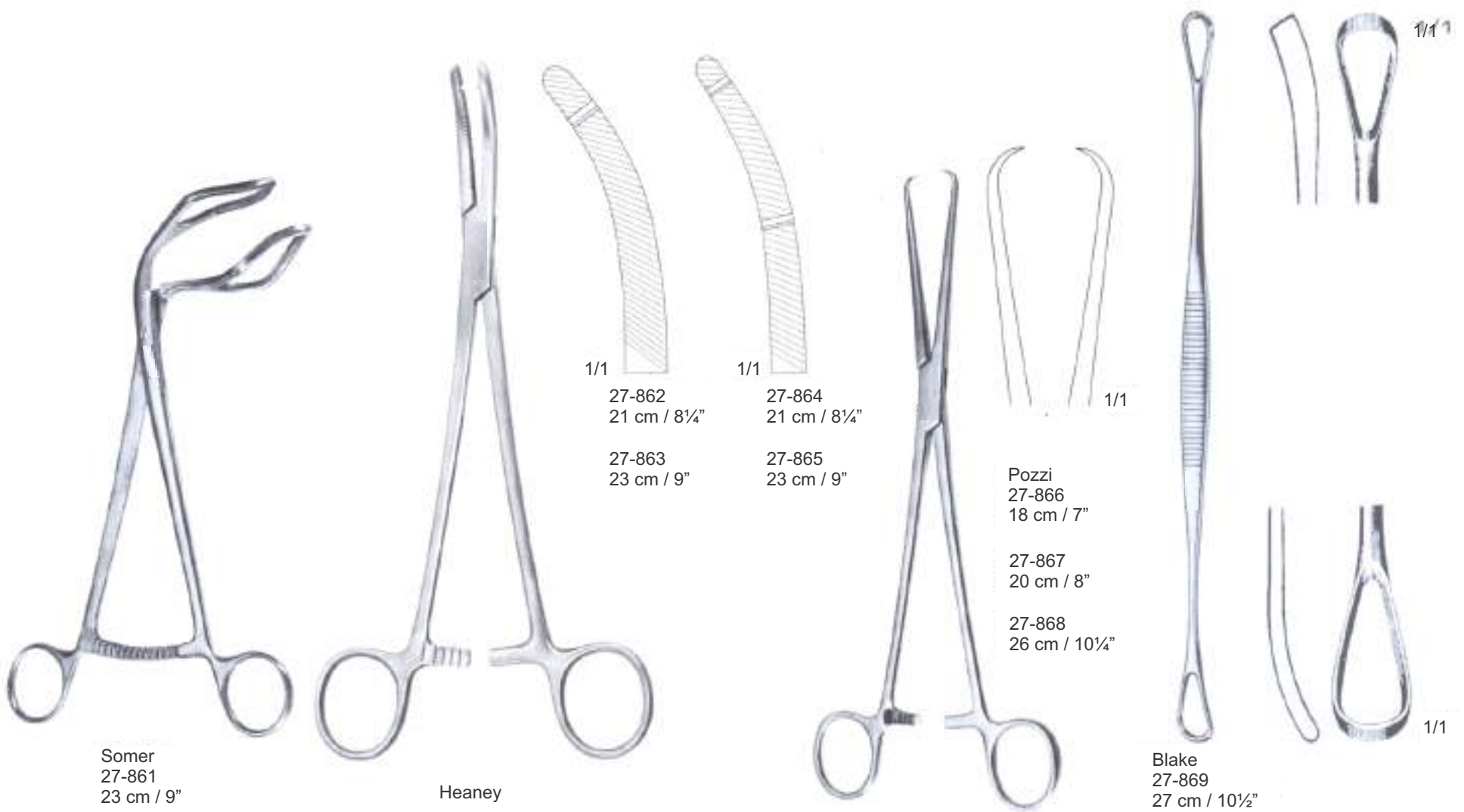

Somer  
27-861  
23 cm / 9"

Heaney

27-862  
21 cm / 8 1/4"

27-863  
23 cm / 9"

27-864  
21 cm / 8 1/4"

27-865  
23 cm / 9"

Pozzi  
27-866  
18 cm / 7"

27-867  
20 cm / 8"

27-868  
26 cm / 10 1/4"

Blake  
27-869  
27 cm / 10 1/2"



Phaneuf  
21.5cm / 8½"



27-871



Bozemann



27-872  
20 cm / 8"



27-873  
24 cm / 9½"



27-874  
26 cm / 10¼"



Littlewood  
27-875  
18.5cm / 7¼"

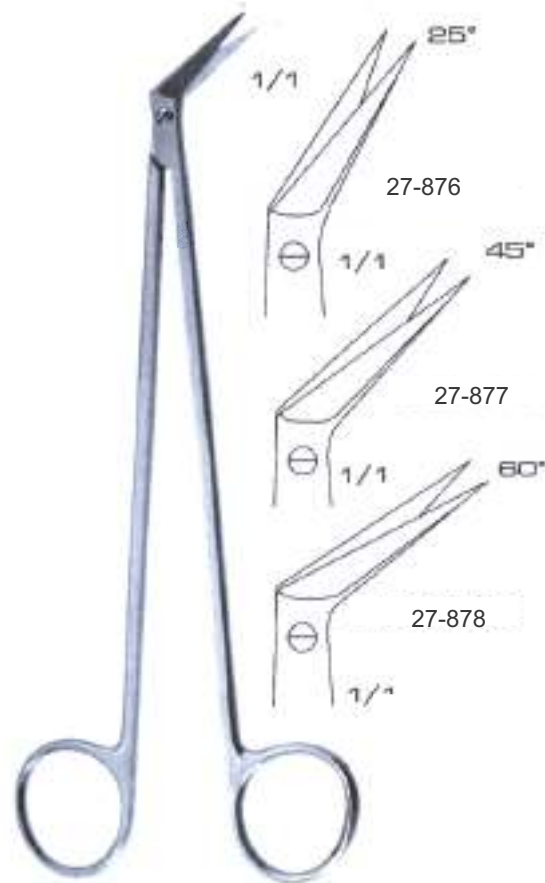

Potts-Smith  
19cm / 7½"



Olsen-Hegar

27-879  
14cm / 5½"

27-880  
18cm / 7"

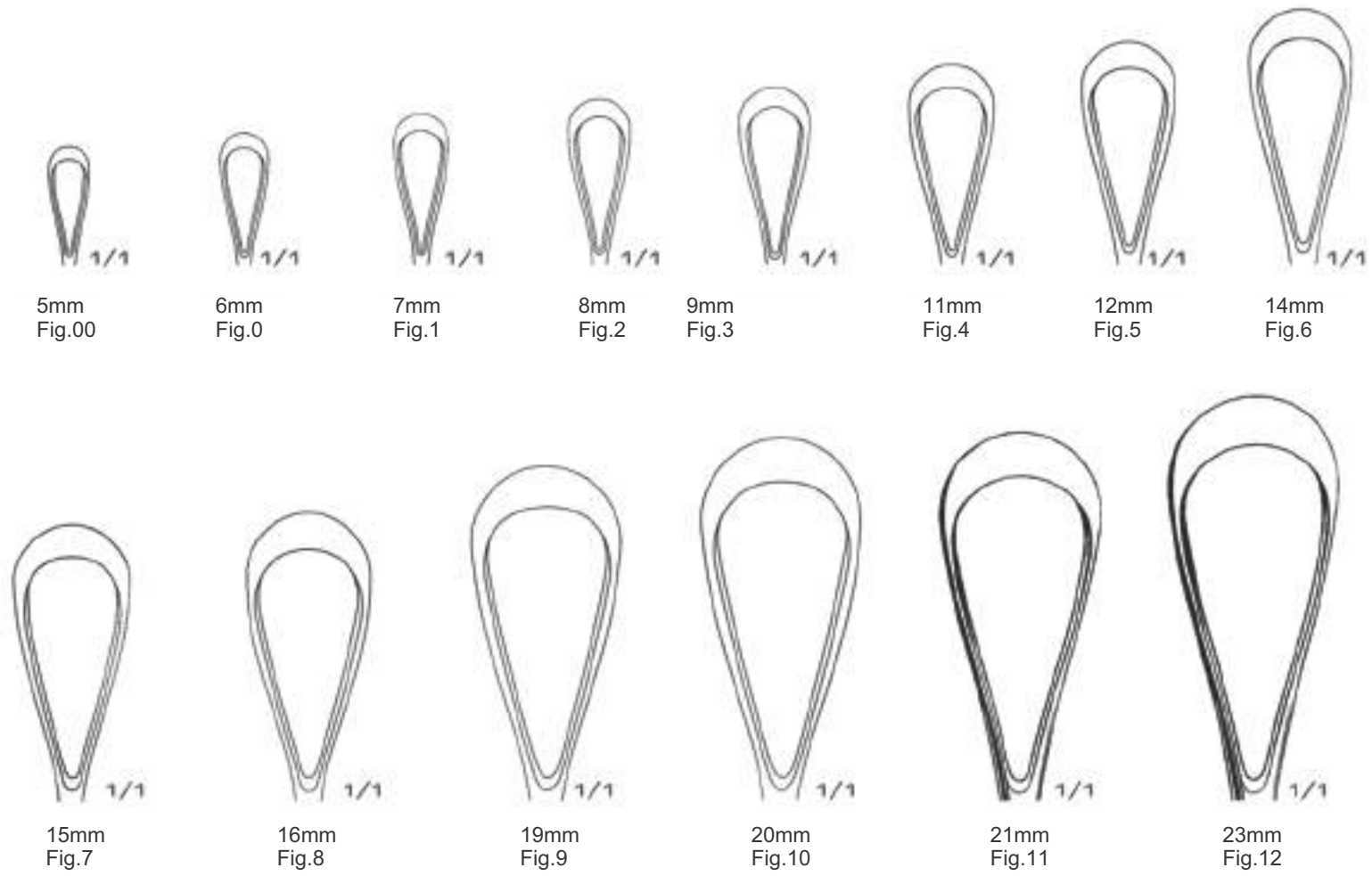

Blunt, rigid

26 cm / 10¼" 31 cm / 12¼"

Fig.00	27-891	27-905
Fig.0	27-892	27-906
Fig.1	27-893	27-907
Fig.2	27-894	27-908
Fig.3	27-895	27-909
Fig.4	27-896	27-910
Fig.5	27-897	27-911
Fig.6	27-898	27-912
Fig.7	27-899	27-913
Fig.8	27-900	27-914
Fig.9	27-901	27-915
Fig.10	27-902	27-916
Fig.11	27-903	27-917
Fig.12	27-904	27-918

Sims



De Bakey  
27-919  
12.5cm / 5"



De Bakey  
Multi-Purpose Forceps,  
angled 60°

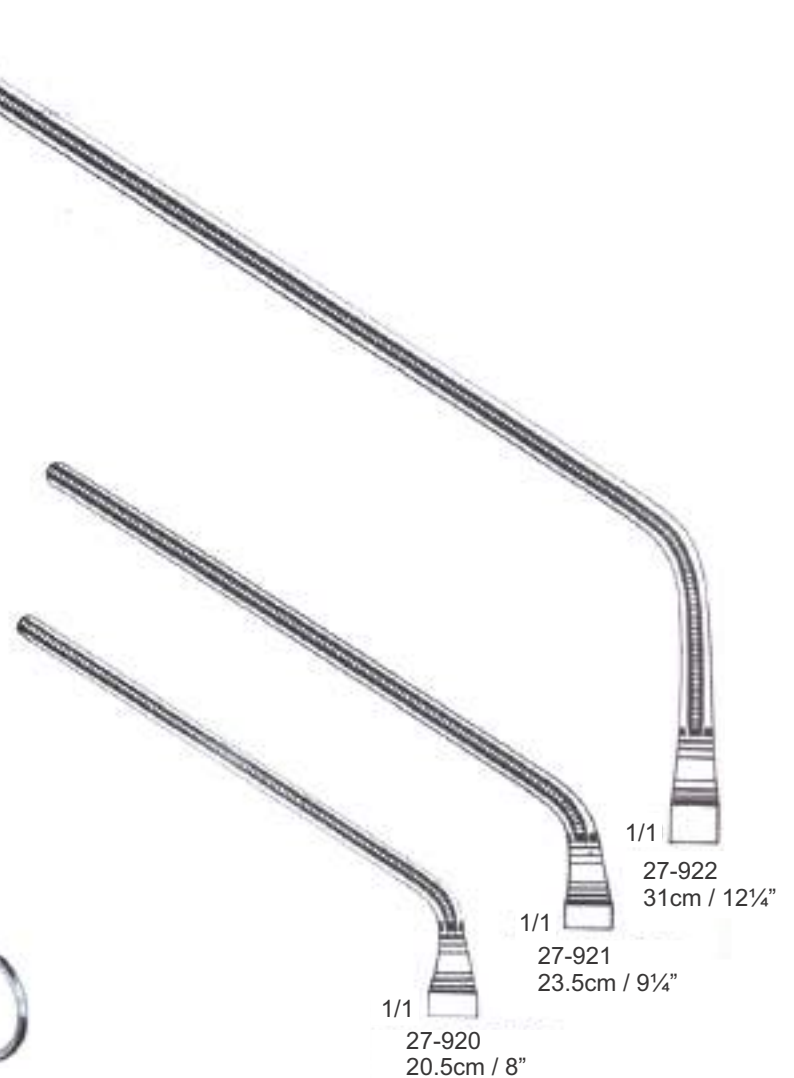

De Bakey-Satinsky  
Vena cava clamps

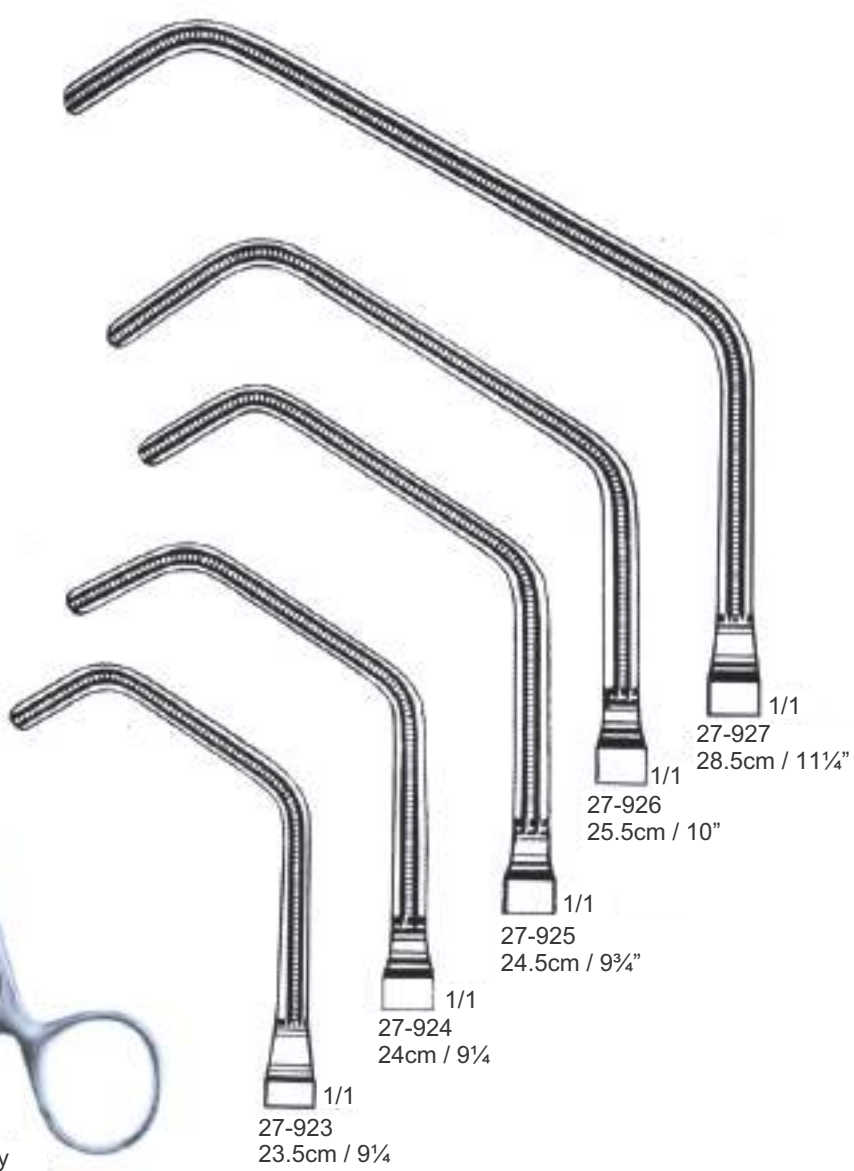

# Alphabetical Index

<b>A</b>	
ABRAHAM, tonsil knife	13
ADSON, forceps	33
ADSON, forceps	37
ALLIS, artery traction forceps	47
ALLIS, intestinal grasping forceps	86
ALY, aesthesiometer	01
AMPUTATING KNIVES	12
ANDREW, tongue depressor	04
ANESTOPHON, stethoscope	02
ARRUGA, forceps	37
ARRUGA, needle holder	61
ASCH, biopsy curettes	112
AUFRIEHT, rasps	138
AYRE, cone knife, 235mm	13
ADSON - BROWN, Tissue Forceps	39
ADSON, Haemostatic Forceps	52
ANGLE, Wire Cutters Cutting Scissors	151
<b>B</b>	
BABCOCK, intestinal grasping forceps	86
BABY-ALLIS, artery traction forceps	47
BACKHAUS, towel clamps	48
BACKHAUS-KOCHER, towel clamps	48
BAILEY, rib spreaders	128
BAKES, gall duct dilators	95
BALFOUR, abdominal retractors	85
BALFOUR-BABY, abdominal retractors	84
BANE-HARTMANN, bone rongeurs	144
BARTH, bone curettes	139
BABY-MOSQUITO, Haemostatic Forceps	51
BABY-ROUX, Retractors	73
BABY-SENN-MILLER, Retractors	73
BEEBE wire scissor	29
BEER, cilia forceps	42
BENGOLEA, delicate forceps	50
BERGER, biopsy forceps	115
BERLINER, percussion hammer	01
BENDING PLIERS, Wire Holding forceps	150
BERTILLON, Examination & Measuring Instruments	10
BIEMER, vein scissor	16
BISHOP-HARMON, forceps	37
BIEMER, Suction Instruments	158
BLAKE, gall stone forceps	96
BLUMENTHAL, bone rongeurs	144
BONNEY, tissue forceps	41
BOSE, tracheal hooks	119
BOWLES, stethoscope	02
BOYS-ALLIS, artery traction forceps	47
BOZEMANN, dressing forceps	108
BOYNTON, Needle Holders	47
BRAUN, artery traction forceps	107
BRAUN, uterine probes	28
BRAUN-STADLER episiotomy scissor	31
BRAUN-STADLER, bandage scissors	102
BRIESKY, vaginal specula	66
BRODIE, probes	34
BROPHY, dissecting forceps	04
BRUENINGS, tongue depressor	13
BRUNINGS, tonsil knife, 215mm	76
BRUNNER, retractors	126
BRUNNER, rib shears	31
BRUNS, plaster scissor	64
BRYANT, sponge forceps	43
BROPHY, Tissue Forceps	38
BROWN, Tissue Forceps	39
BUCHS, retractors	75
BUCHWALD, tongue depressor	04
BUCK, neurological hammer	01
BUMM, ovum forceps	230
BUCK, Ear Curettes	110
<b>C</b>	
CASPAR, retractor	75
CASPAR, Micro scissor 115mm	16
CASTROVIEJO, tissue forceps	37
CASTROVIEJO, micro spring scissor	15
CASTROVIEJO, needle holder	61
CASTROVIEJO, eye scissor 110mm	15
CASTROVIEJO, eye scissor 115mm	15
CATLIN, amputating knife 160mm	12
CALIPER, Examination & Measuring Instruments	10
CARREL, Haemostatic Forceps	51
CARROLL, Examination & Measuring Instruments	10
CASPAR, Rongeurs	133
CASPAR, Rongeurs	134
CASTROVIEJO, Examination & Measuring Instruments	10
CHAPUT, artery traction forceps	47
CLOWARD, lamina Spreaders	83
CLAUS PLIER, Wire Cutting Plier With T.C. Inserts	187
CLAUS PLIER, Wire Cutting Plier With T.C. Inserts	187
COAKLEY, antrum trocars	100
COLLIN, intestinal grasping forceps	86
COLLIN, rib shears	126
COLLIN, sponge and dressing forceps	44
COLLIN, tongue forceps	05
COLLIN, vaginal spatula	101
CONE KNIFE 235mm11	13
CONVERSE, fine wound retractor	69
COOLEY, multi purpose clamps	122
COTTLE, retractors	71
COTTLE, nasal scissor	25
COTTLE, fine wound retractor	69
COTTLE, mallets	140
COLLIN, Examination & Measuring Instruments	10
COLLIN, Intestinal Grasping Forceps	46
COLLIN, Retractors	73
COLLIN-HARTMANN, Retractors	73
COTTLE, Forceps, Bayonet - Shaped	40
COTTLE, Nasal Specula	91
CRILE, Haemostatic Forceps	52
CRILE, Haemostatic Forceps	52
CRILE, Retractors	73
CUTTING PLIER, Wire Cutting Plier With T.C. Inserts	187
CRAFOORD, haemostatic forceps	50
CRILE, needle holder	63
CUSCO, vaginal specula	101
CUSHING, wound and vein retractor	71
CUSHING, dissecting forceps	34
CUSHING-KOCHER, retractors	71
CZERNY, gall stone forceps	96
CZERNY, retractors	72

# Alphabetical Index

<b>D</b>		<b>F</b>	
DAVIDSON, scapula retractors	77	FARABEUF, Retractors	73
DAVIS, vascular spatulas	120	FEILCHENELD, splinter forceps	42
DANDY, Haemostatic Forceps	51	FERGUSON, haemorrhoidal forceps	93
DE BAKEY, forceps	36	FERGUSON, suction instrument	163
DE BAKEY, anastomosis clamps	89	FERGUSON-ACKLAND, mouth gag	05
DE BAKEY, anastomosis clamps	125	FINOCHIETTO, forceps	58
DE BAKEY, arteriotomy scissor	22	FINOCHIETTO, rib spreader	127
DE BAKEY, vana cava clamps	123	FINSEN, tracheal hooks	119
DE BAKEY, multi purpose clamps	122	FIBER OPTIC, laryngoscopes	09
DE BAKEY, retractors	82	FINGER NAIL DRIL, Finger Nail Instruments	155
DE BAKEY, atraumata	121	FINGER RING SAW, Finger Nail Instruments	155
DEAN, nasal and tonsil scissor	25	FINSTERER, Suction Instruments	161
DEAVER, retractors	77	FLAT-NOSED PLIERS, Wire Holding forceps	150
DEAVER, surgical scissor (flat lock)	21	FOERSTER-BALLENGER, Tissue Grasping Forceps	45
DE-BAKEY, bulldog clamps	49	FORCEPS, Finger Nail Instruments	155
DEJERINE, percussion hammer	01	FOREGGER, laryngoscopes	09
DELICATE DISSECTING FORCEPS	33	FOMON, nasal scissor	19
DELICATE SCISSORS, blunt points	19	FORD-BOWLES, stethoscope	02
DELICATE SCISSORS, sharp points	18	FOWLER, tonsil knife	13
DELICATE SCISSORS, sharp points	19	FRANCKE, blood lancet	06
DENHARDT, mouth gag	05	FRAZIER, fine wound retractor	69
DENIS-BROWENE, intestinal forceps	41	FRAZIER, suction instruments	163
DERRA, multi purpose clamps	122	FREER, fine wound retractor	69
DESCHAMPS, ligature needles	65	FREER, vascular spatulas	120
DESJARDINS, gall duct forceps	95	FRENZEL, tongue depressor	04
DESJARDINS, gall stone forceps	96	FRICKE, haemostatic forceps	56
DESJARDINS, gall stone scoops	95	FRITSCH, retractor	79
DESMARRES, wound and vein retractors	71		
DEMEL, Cerclage Instruments	148	<b>G</b>	
DIAGNOSTIC SETS	07	GALLAHER, rasp	126
DICK, vaginal clamps and compression forceps	59	GELPI, special retractors	82
DIEFFEBACH, bulldog clamps	49	GELPI, vaginal retractors	105
DINGMANN, bone holding forceps	142	GERALD, dissecting forceps	34
DISSECTING KNIVES	11	GIERTZ-STILLE, rib shears	126
Dissection Instruments	164	GILL, tissue forceps	37
Dissection Instruments	165	GILL-HESS, tissue forceps	37
Dissection Instruments	166	GILLIES, fine wound retractor	69
DITTEL, metal bougies	80	GILLIES, needle holder	63
DOYEN, abdominal retractors	79	GLOVER, bulldog clamp	49
DOYEN, intestinal clamps	87	GLUCK, rib shears	126
DOYEN, ovum forceps	230	GOOD, tonsil scissors	25
DOYEN, probes	66	GORNEY, suction instruments	163
DOYEN, towel clamps	48	GOSSET, abdominal retractors	84
DOYEN, vaginal specula	104	GRAEFE, fine wound retractor	69
DUROGRIP, Wire Holding forceps	149	GRAVE, vaginal specula	102
DUROTIP, Cutting Pliers	152	GROSS, dressing forceps	43
DUROTIP, Cutting Pliers	153	GUEDEL-NEGUS, laryngoscope	08
DUROTIP, Wire Cutters Cutting Scissors	151	GUTHRIE, fine wound retractor	69
DUVAL-COLLIN, Intestinal Grasping Forceps	46	GUYON, kidney clamps	97
DUPLAY, sponge and dressing forceps	43	GERALD, Tissue Forceps	38
DUVAL, intestinal forceps	41	GILLIES, Tissue Forceps	38
		GOLDSMITH, Nasal Specula	91
<b>E</b>		GRAEFE, Tissue Forceps	39
EISELSBERD, needle holder	63	GRAEFE, Tissue Forceps	39
ELSCHING, forceps	37	GRUENWALD, Forceps, Bayonet – Shaped	40
ENGL.MOD, towel clamps	48		
EPPENDORF, biopsy forceps	115	<b>H</b>	
ESMARCH, cloth and plaster scissors	31	HALLE, vascular spatulas	120
EISELSBERG-MATHIEU, Needle Holders	64	HALSTED-MOSQUITO, haemostatic forceps	50
EXTRACTION PLIERS, Wire Holding forceps	150	HARTMANN, intestinal clamps	87

# Alphabetical Index

HARVEY, plate scissors	29	KELLY, tissue grasping forceps	44
HAJEK-KOFLER, Punches	130	KERN-LANE, bone holding forceps	143
HALSTED, Haemostatic Forceps	52	KERRISON-JACOBY, punches	129
HALSTED-MOSQUITO, Haemostatic Forceps	51	KERSTING, anastomosis forceps	89
HARTMANN, Ear Polypus Forceps	112	KELLY, Haemostatic Forceps	51
HARTMANN-HALLE, Nasal Specula	91	KERRISON, Punches	130
HARTMANN-HERZFELR, Ear Polypus Forceps	112	KILLIAN, bone shear	26
HARTMANN-HOFFMAR, Ear Polypus Forceps	112	KILLIAN, rectal spatula	90
HARTMANN-WULLSTEIN, Ear Polypus Forceps	112	KILNER, fine dissecting scissors	22
HARVEY, Wire Cutters Cutting Scissors	151	KILNER, fine wound retractor	69
HEANEY, needle holder	62	KILNER, dissecting scissor	22
HEGAR, needle holder	62	KILLIAN, Nasal Specula	90
HEGAR-OLSEN, needle holder	63	KIRSCHNER, Cutting Pliers	154
HEGER, uterine dilators	106	KIRSCHNER, Wire Extension	147
HEISS, haemostatic forceps	50	KOCHER, Haemostatic Forceps	52
HEISS, dressing forceps	58	KOCHER, Haemostatic Forceps	54
HEISTER, mouth gag	05	KOCHER-OCHSNER, Haemostatic Forceps	55
HENING, plaster spreader	157	KLIMA ROSEGGGER, trocars	100
HERGET, biopsy forceps	113	KOCHER, retractor	71
HERTZLER, abdominal retractors	84	KOCHER, bladder retractors	99
HERTZLER, rib spreaders	127	KOCHER, bone retractor	74
HESS, tissue forceps	37	KOCHER, retractors	75
HEYMANN-KNIGHT, scissors	25	KOLLE, blood lancet	06
HEYWOOD-SMITH, ovum forceps	109	KONIG, elevators	135
HEYWOOD-SMITH, sponge holding forceps	44	KONIG, raspatories	137
HEYWOOD-SMITH, tongue forceps	05	KONISATION SMESSER, retractors	57
HOLLOW NEEDLE, Suction Instruments	159	KRAUSE, biopsy tip	115
HOUSE, Suction Instruments	161	KRISTELLER, vaginal specula	102
HUBER, biopsy forceps	115	KRISTELLER, vaginal specula	103
HUNT, tumor & vessel forceps	32	KRONECKER, suture instruments	65
HUNTER, splinter forceps	42	KRONLEIN, haemostatic forceps	56
		KUMMEL, intestinal spatula	80
<b>I</b>			
INGE, lamina spreaders	83	<b>L</b>	
INTEROSSEOUS, cartilage knife	12	LABORDE, tracheal dilators	119
IVES-FANSLER, anoscopies	92	LAHEY, artery traction forceps	47
<b>J</b>		LAHEY, gall duct forceps	94
JACKSON BURROWS, retractors	82	LANE TRETOWAN, bone levers	136
JACOBSON, bone curettes	139	LANE, bone holding forceps	143
JACOBSON, needle holder	61	LANE, bone levers	136
JAEGAR, fine wound retractor	69	LANE, tissue forceps	41
JAMESON, dissecting scissor	22	LANE, towel clamps	48
JAMESON, needle holder	62	LANGE-HOHMANN, bone levers	136
JANSEN, bone curettes	139	LANGENBACK, bone levers	135
JANSEN, bone rongeurs	144	LANGENBECK, with triangle handle	70
JOHNS-HOPKING, bulldog clamps	49	LANGENBECK, flap knife	12
JOLL (FRIEDMAN), retractors	82	LARYNGEAL MIRRORS	06
JOLL, vaginal retractors	105	LAWRENCE, ligature forceps	58
JONES, towel clamps	48	LANDOLT, Suction Instruments	160
JOSEPH, bone file	138	LANDOLT, Suction Instruments	161
JOSEPH, dura and skin retractor	69	LANGENBECK, Ear Curettes	110
JOSEPH, raspatories	137	LEBSCHKE, rib shears	126
JUDD-MASSON, bladder retractors	99	LEGUEU, bladder retractors	99
JANSEN, FORCEPS, Bayonet - Shaped	40	LEKSELL-STILLE, bone rongeurs	145
<b>K</b>		LERICHE, intestinal spatula	80
KADER, intestinal spatula	80	LEWIS, bone file	138
KALT, needle holder	61	LISTER, bandage scissor	30
KELLY, ovum forceps	109	LISTER, cloth scissor	30
KELLY, anoscopies	92	LISTER, sponge forceps	43
		LISTON, bone cutting forceps	146

# Alphabetical Index

LOCKHART-MUMMERY, probes	66	MULLER, dura and skin retractor	69
LOCKWOOD, Intestinal Grasping Forceps	46	MURPHY, head band	03
LUCAE, FORCEPS, Bayonet – Shaped	40	MUSEUX, tissue grasping forceps	47
LUER, Retractors	73		
LOCKLIN, delicate scissor	25	<b>N</b>	
LOPEZ-REINKE, suction instruments	163	NASAL SCISSORS	25
LOWER, gall duct forceps	94	NAUJOKS wire scissors	29
LOWMAN, bone clamps	143	NAIL SPLITTING, Finger Nail Instruments	155
LOWMAN-GERSTER, bone clamps	143	NEEDLE HOLDER, for micro surgery	48
LOWMAN-HOGLUND, bone clamps	143	NEGUS, tonsil forceps	57
LUCAS, gouges	141	NELATON, probes	66
LUER-KORTE, gall stone scoops	80	NELSON, lung dissecting forceps	41
LURE, bone rongeurs	144	NISSEN, gall duct forceps	94
		NOTO, ovum forceps	109
<b>M</b>		NOTO, sponge holding forceps	44
MAGILL, laryngoscope	07	NOVAK-SCHOECKAERT, biopsy curettes	111
MALTZ, rasps	138	NOYES, micro spring scissor	15
MANNERFELT, osteotomes	141		
MANNERFELT, retractors	70	<b>O</b>	
MARTIN, uterine probes	107	OLIVECRONA, dura scissors	24
MARTINI, bone curettes	139	OLIVECRONA, trigeminal knife	13
MASING, retractors	71	OTOSCOPE SETS	07
MASSON, needle holder	62	OTOSCOPE, Diagnostic Sets	07
MASSON-LUETHY, needle holder	62		
MATHIEU, retractors	72	<b>P</b>	
MAYO, dissecting scissors	23	PARTSCH, raspatories	137
MAYO, uterine probes	107	PARTSCH, gouges	141
MAYO-HARRINGTON, dissecting scissors	23	PARTSCH, raspatories	137
MAYO-NOBLE, dissecting scissors	23	PAYR, pylorus clamps	86
MAYO-STILLE, dissecting scissors	23	PEAN, haemostatic forceps	57
MARTIN, Nasal Specula	90	PEAN, haemostatic forceps	51
MATHIEU, Needle Holders	64	PEAN, kidney clamps	97
MATHIEU-STILLE, Needle Holders	64	PEDERSON, vaginal specula	102
MC INDOE, forceps	34	PEET, splinter forceps	42
MC KENTY, raspatories	137	PELKMANN, uterine dressing forceps	108
MEAD, mallets	140	PERKINS, self retaining retractors	81
MC INDOE, Tissue Forceps	38	PIERCE, trocars	100
MCINTOSH, laryngoscopes	09	PINARD, wooden stethoscope	02
MEDIUM, Dissecting Forceps	35	PLESTER, retractors	81
MICRO-HALSTED, Haemostatic Forceps	51	PLESTER, suction instruments	163
MILLIN, Needle Holders	64	POOL, suction instruments	162
MICHEL, laryngeal mirrors	06	POTTS-SMITH, cardiovascular scissor	24
MICRO SCISSORS, laterally angled	17	PROBES	67
MICRO-ADSON, forceps	33	PARKER, Retractors	73
MICRO-ADSON, forceps	37	PEAN, Haemostatic Forceps	52
MIDDELDORPF, retractors	75	PEAN, Haemostatic Forceps	53
MIKULICZ, tissue forceps	57	PEAN, Haemostatic Forceps	54
MIKULICZ, intestinal spatula	80	PENNINGTON, Tissue Grasping Forceps	45
MIKULICZ, retractors	78	PROVIDENCE-HOSPITAL, Haemostatic Forceps	51
MILLER, laryngoscope	08		
MILLIN, bladder retractors	99	<b>Q</b>	
MIXTER, ligature forceps	58	QUERVAIN, bone levers	113
MOD.USA, plaster spreader	127		
MORRIS, anastomosis clamps	89	<b>R</b>	
MOYNIHAN, haemostatic forceps	57	RABINER, neurological hammer	01
MOYO-HEGAR, needle holder	62	RANDALL, biopsy curettes	111
MOD. WIEN, Nasal Specula	91	RANDALL, kidney stone forceps	98
MOLTGEN, Examination & Measuring Instruments	10	RECAMIER, uterine scoops	116
MULLAR, Wire Cutting Plier With T.C. Inserts	187	REYNOLDS, dissecting scissors	22
MULLER LIGATURE FORCEPS	49	RICHTER, vaginal retractors	105
MULLER VESSEL CLIPS	49	ROCHESTER-CARMALT, haemostatic forceps	57
		ROEDER, towel clamps	48



# Alphabetical Index

ROUX, retractors	72	STERBERG, Retractors	
RUDD, haemorrhoidal ligator	93	STRULLY, cardiovascular scissors (pointed)	24
RUMEL, dissecting forceps	58	SUCTION INSTRUMENTS	162
RUSS-MODELL, tissue forceps	41	SURGICAL SCISSORS, incision	21
ROHRSCHEIDER, needle holder	61	SURGICAL SCISSORS, serrated	20
ROLLET, dura and skin retractor	69	SURGICAL SCISSORS, slender type	20
ROSER KONIG, mouth gag	05	SURGICAL SCISSORS, standard	20
RAMPLEY, Tissue Grasping Forceps	45	SURGICAL SCISSORS, standard	20
RANKIN, Haemostatic Forceps	52	SUTURING INSTRUMENT SET	68
REILL, Cutting Pliers	152	SYSTRUNK, nail splitting scissors	21
REPLACEMENT LAMP, laryngoscopes	09	SPENCER-WELLS, Haemostatic Forceps	
ROCHESTER-OCHSNER, Haemostatic Forceps	54	SYSTRUNK, Finger Nail Instruments	
ROCHESTER-PEAN, Haemostatic Forceps	53		
ROSE, Retractors	73		
ROUND PLIERS, Wire Holding forceps	150		
<b>S</b>		<b>T</b>	
SAENGER, ovum forceps	118	TAKAHASHI, rongeur	112
SAMII, tumor grasping forceps	32	TAYLOR, percussion hammer	01
SATINSKY, vena cava scissors	24	TAKAHASHI, Rongeurs	132
SAUPE, cilia forceps	42	THOREK, cardiovascular scissors	24
SCALPEL HANDLES	14	THORPE, corneal forceps	33
SCHAAF, cilia forceps	42	TIECK-HALLE, Nasal Specula	90
SCHAEDEL, towel clamps	48	TOENNIS, Wire Cutting Plier With T.C. Inserts	187
SCHEINMANN, biopsy forceps	115	TOWNLEY, Examination & Measuring Instruments	10
SCHIMMELBUSCH, ether mask	05	TOBOLD, tongue depressors	04
SCHMID, vascular spatulas	120	TOENNIS ADSON, dissecting scissors	22
SCHOEMAKER-LOTH, needle holder	63	TOENNIS, dissecting scissors	22
SCHOENBORN, retractors	71	TOENNIS, fine wound retractor	69
SCHRODER, uterine scoops	116	TOENNIS, vascular spatulas	120
SCHUMACHER, rib shears	126	TOENNIS, needle holder	63
SCHUMACHER, umbilical scissors	28	TRELAT, raspatories	137
SCHUMASHER, biopsy forceps	114	TRIGEMINAL KNIFE	13
SCOVILLE-RICHTER, retractors	67	TROCARS	100
SEGOND, myomatome	13	TROEMNER, percussion hammer	01
SEIDL, vaginal specula	102	TROUSSEAU, tracheal dilators	119
SEIDL-DBP, biopsy forceps	114	TROCAR, Suction Instruments	159
SELLORS, rib spreaders	128	TROELTSCH, FORCEPS, Bayonet – Shaped	40
SEMKEN, dissecting forceps	34	TUFFIER, rib spreaders	127
SEMKEN, tissue forceps	37	TUTTLE, lung dissecting forceps	41
SENN-MILLER, Retractors	73		
SEUTIN, plaster scissor	31	<b>U</b>	
SHAPLEIGH, Ear Curettes	110	UMBILICAL CORD SCISSORS	28
SIMON, uterine scoops	116	UNIVERSAL BANDAGE SCISSORS	30
SIMPLEX, tongue depressor	04	UNIVERSAL TROCARS	100
SIMPSON, uterine probes	107	US-ARMY, retractors	72
SIMPSON-BRAUN, obstetrics forceps	117		
SIMS, gynaecology scissors	27	<b>V</b>	
SIMS, vaginal specula	102	VANNAS, micro spring scissors	15
SIMS, vaginal specula	90	VERNIER, Examination & Measuring Instruments	10
SIMS, rectal specula	90	WISE GRIP, Wire Holding forceps	150
SIMS, uterine probes	107	VOLKMANN, bone curettes	139
SMOOTH JAWS FORCEPS	34	VOLKMANN, bone retractors	74
ST.MARTIN, tissue forceps	37		
STEMBERG, tongue depressor	04		
STIEGLITZ, splinter forceps	42		
STILLE, bone rongeurs	145		
STILLE-AESULAP, plaster shears	156		
STILLE-RUSKIN, bone rongeurs	145		
STRACK, wire scissor	29		
STRASSBURGER Tissue forceps	41		
STANDARD, Dissecting Forceps	35		
STANDARD, Tissue Forceps	39		

## Alphabetical Index

### W

WANGENSTEEN, needle holder	62
WARTENMERG, pinwheel	01
WAGNER, Rongeurs	134
WAUGH, Tissue Forceps	38
WEBER, anastomosis clamps	124
WECKER, eye scissors	15
WEIL-BLAKESLEY, rongeurs	112
WEITLANER, self retaining retractors	81
WERTHEIM, gynaecology scissors	27
WERTHEIM, clamps and forceps	59
WERTHEIM-CULLEN, vaginal clamps	60
WIEDER, tongue depressor	04
WEIL-BLAKESLEY, Rongeurs	132
WILLIGER, bone curettes	139
WILLIGER, elevators	135
WILLIGER, raspatories	137
WINTER, ovum forceps	118
WILDE, Forceps, Bayonet – Shaped	40
WOLFF, plaster breakers	157
WULLSTEIN, retractors	81
WULLSTEIN, Suction Instruments	160

### Y

YASARGIL, needle holder	61
YASARGIL, tumor grasping forceps	32
YASARGIL-SAMII, tumor grasping forceps	32
YASARGIL, Suction Instruments	160
YASARGIL, Suction Instruments	161
YASRGIL, micro scissors	17
YEOMAN, biopsy forceps	113
YOUNG, tongue forceps	05
YOUNG- HRYNTSCHAK, Needle Holders	64
YOUNG-MILLIN, Needle Holders	64

### Z

ZENKER, ligature	58
ZENKER, retractors	77
ZIEGLER, head band	03
ZIEGLER, head mirror	03

# GREAT CARE GCI

---

---

## INSTRUMENTS

P.O. Box 2363,

Kashmir Road, Sialkot 51310 - Pakistan

Tel: +92 - 52 - 3556421 / Fax: +92 - 52 - 3556422

Cell: +92 - 300 - 8611391

E-mail: [info@greatcareinst.com](mailto:info@greatcareinst.com) / [info@greatcare.com.pk](mailto:info@greatcare.com.pk)

Web: [www.greatcare.com.pk](http://www.greatcare.com.pk)

